



ROHDE & SCHWARZ

Test and
Measurement Division

Operating Manual

SPECTRUM ANALYZER

FSEA20/30

1065.6000.20/.25/35

FSEB20/30

1066.3010.20/.25/35

FSEM20/30

1080.1505.20/.21/.25

1079.8500.30/.31/.35

FSEK20/30

1088.1491.20/.21/.25

1088.3494.30/.31/.35

Volume 1

Operating manual consists of 2 volumes

Printed in the Federal
Republic of Germany

Tabbed Divider Overview

Volume 1

Data Sheet

Safety Instructions

Certificate of quality

EC Certificate of Conformity

Support Center

List of R & S Representatives

Manuals for Signal Analyzer FSE

Tabbed Divider

- | | | |
|----|------------|------------------------|
| 1 | Chapter 1: | Putting into Operation |
| 2 | Chapter 2: | Getting Started |
| 3 | Chapter 3: | Operation |
| 4 | Chapter 4: | Functional Description |
| 10 | | Index |

Volume 2

Safety Instructions

Manuals for Signal Analyzer FSE

Tabbed Divider

- | | | |
|----|------------|-------------------------------------|
| 5 | Chapter 5: | Remote Control – Basics |
| 6 | Chapter 6: | Remote Control – Commands |
| 7 | Chapter 7: | Remote Control – Program Examples |
| 8 | Chapter 8: | Maintenance and Hardware Interfaces |
| 9 | Chapter 9: | Error Messages |
| 10 | | Index |



Before putting the product into operation for the first time, make sure to read the following



Safety Instructions

Rohde & Schwarz makes every effort to keep the safety standard of its products up to date and to offer its customers the highest possible degree of safety. Our products and the auxiliary equipment required for them are designed and tested in accordance with the relevant safety standards. Compliance with these standards is continuously monitored by our quality assurance system. This product has been designed and tested in accordance with the EC Certificate of Conformity and has left the manufacturer's plant in a condition fully complying with safety standards. To maintain this condition and to ensure safe operation, observe all instructions and warnings provided in this manual. If you have any questions regarding these safety instructions, Rohde & Schwarz will be happy to answer them.

Furthermore, it is your responsibility to use the product in an appropriate manner. This product is designed for use solely in industrial and laboratory environments or in the field and must not be used in any way that may cause personal injury or property damage. You are responsible if the product is used for an intention other than its designated purpose or in disregard of the manufacturer's instructions. The manufacturer shall assume no responsibility for such use of the product.

The product is used for its designated purpose if it is used in accordance with its operating manual and within its performance limits (see data sheet, documentation, the following safety instructions). Using the products requires technical skills and knowledge of English. It is therefore essential that the products be used exclusively by skilled and specialized staff or thoroughly trained personnel with the required skills. If personal safety gear is required for using Rohde & Schwarz products, this will be indicated at the appropriate place in the product documentation.

Symbols and safety labels

| | | | | | | | |
|--------------------------------|------------------------------------|--------------------------|----------------------|-------------|--------|-----------------|--|
| | | | | | | | |
| Observe operating instructions | Weight indication for units >18 kg | Danger of electric shock | Warning! Hot surface | PE terminal | Ground | Ground terminal | Attention! Electrostatic sensitive devices |

| | | | | | |
|-----------------------|--------------------|---------------------|--------------------------|------------------------------------|--|
| | | | | | |
| Supply voltage ON/OFF | Standby indication | Direct current (DC) | Alternating current (AC) | Direct/alternating current (DC/AC) | Device fully protected by double/reinforced insulation |

Safety Instructions

Observing the safety instructions will help prevent personal injury or damage of any kind caused by dangerous situations. Therefore, carefully read through and adhere to the following safety instructions before putting the product into operation. It is also absolutely essential to observe the additional safety instructions on personal safety that appear in other parts of the documentation. In these safety instructions, the word "product" refers to all merchandise sold and distributed by Rohde & Schwarz, including instruments, systems and all accessories.

Tags and their meaning

| | |
|-----------|--|
| DANGER | This tag indicates a safety hazard with a high potential of risk for the user that can result in death or serious injuries. |
| WARNING | This tag indicates a safety hazard with a medium potential of risk for the user that can result in death or serious injuries. |
| CAUTION | This tag indicates a safety hazard with a low potential of risk for the user that can result in slight or minor injuries. |
| ATTENTION | This tag indicates the possibility of incorrect use that can cause damage to the product. |
| NOTE | This tag indicates a situation where the user should pay special attention to operating the product but which does not lead to damage. |

These tags are in accordance with the standard definition for civil applications in the European Economic Area. Definitions that deviate from the standard definition may also exist. It is therefore essential to make sure that the tags described here are always used only in connection with the associated documentation and the associated product. The use of tags in connection with unassociated products or unassociated documentation can result in misinterpretations and thus contribute to personal injury or material damage.

Basic safety instructions

1. The product may be operated only under the operating conditions and in the positions specified by the manufacturer. Its ventilation must not be obstructed during operation. Unless otherwise specified, the following requirements apply to Rohde & Schwarz products:
prescribed operating position is always with the housing floor facing down, IP protection 2X, pollution severity 2, overvoltage category 2, use only in enclosed spaces, max. operation altitude max. 2000 m. Unless specified otherwise in the data sheet, a tolerance of $\pm 10\%$ shall apply to the nominal voltage and of $\pm 5\%$ to the nominal frequency.
2. Applicable local or national safety regulations and rules for the prevention of accidents must be observed in all work performed. The product may be opened only by authorized, specially trained personnel. Prior to performing any work on the product or opening the product, the product must be disconnected from the supply network. Any adjustments, replacements of parts, maintenance or repair must be carried out only by technical personnel authorized by Rohde & Schwarz. Only original parts may be used for replacing parts relevant to safety (e.g. power switches, power transformers, fuses). A safety test must always be performed after parts relevant to safety have been replaced (visual inspection, PE conductor test, insulation resistance measurement, leakage current measurement, functional test).
3. As with all industrially manufactured goods, the use of substances that induce an allergic reaction (allergens, e.g. nickel) such as aluminum cannot be generally excluded. If you develop an allergic reaction (such as a skin rash, frequent sneezing, red eyes or respiratory difficulties), consult a physician immediately to determine the cause.

Safety Instructions

4. If products/components are mechanically and/or thermally processed in a manner that goes beyond their intended use, hazardous substances (heavy-metal dust such as lead, beryllium, nickel) may be released. For this reason, the product may only be disassembled, e.g. for disposal purposes, by specially trained personnel. Improper disassembly may be hazardous to your health. National waste disposal regulations must be observed.
5. If handling the product yields hazardous substances or fuels that must be disposed of in a special way, e.g. coolants or engine oils that must be replenished regularly, the safety instructions of the manufacturer of the hazardous substances or fuels and the applicable regional waste disposal regulations must be observed. Also observe the relevant safety instructions in the product documentation.
6. Depending on the function, certain products such as RF radio equipment can produce an elevated level of electromagnetic radiation. Considering that unborn life requires increased protection, pregnant women should be protected by appropriate measures. Persons with pacemakers may also be endangered by electromagnetic radiation. The employer is required to assess workplaces where there is a special risk of exposure to radiation and, if necessary, take measures to avert the danger.
7. Operating the products requires special training and intense concentration. Make certain that persons who use the products are physically, mentally and emotionally fit enough to handle operating the products; otherwise injuries or material damage may occur. It is the responsibility of the employer to select suitable personnel for operating the products.
8. Prior to switching on the product, it must be ensured that the nominal voltage setting on the product matches the nominal voltage of the AC supply network. If a different voltage is to be set, the power fuse of the product may have to be changed accordingly.
9. In the case of products of safety class I with movable power cord and connector, operation is permitted only on sockets with earthing contact and protective earth connection.
10. Intentionally breaking the protective earth connection either in the feed line or in the product itself is not permitted. Doing so can result in the danger of an electric shock from the product. If extension cords or connector strips are implemented, they must be checked on a regular basis to ensure that they are safe to use.
11. If the product has no power switch for disconnection from the AC supply, the plug of the connecting cable is regarded as the disconnecting device. In such cases, it must be ensured that the power plug is easily reachable and accessible at all times (length of connecting cable approx. 2 m). Functional or electronic switches are not suitable for providing disconnection from the AC supply. If products without power switches are integrated in racks or systems, a disconnecting device must be provided at the system level.
12. Never use the product if the power cable is damaged. By taking appropriate safety measures and carefully laying the power cable, ensure that the cable cannot be damaged and that no one can be hurt by e.g. tripping over the cable or suffering an electric shock.
13. The product may be operated only from TN/TT supply networks fused with max. 16 A.
14. Do not insert the plug into sockets that are dusty or dirty. Insert the plug firmly and all the way into the socket. Otherwise this can result in sparks, fire and/or injuries.
15. Do not overload any sockets, extension cords or connector strips; doing so can cause fire or electric shocks.
16. For measurements in circuits with voltages $V_{rms} > 30 V$, suitable measures (e.g. appropriate measuring equipment, fusing, current limiting, electrical separation, insulation) should be taken to avoid any hazards.
17. Ensure that the connections with information technology equipment comply with IEC 950/EN 60950.
18. Never remove the cover or part of the housing while you are operating the product. This will expose circuits and components and can lead to injuries, fire or damage to the product.

Safety Instructions

19. If a product is to be permanently installed, the connection between the PE terminal on site and the product's PE conductor must be made first before any other connection is made. The product may be installed and connected only by a skilled electrician.
20. For permanently installed equipment without built-in fuses, circuit breakers or similar protective devices, the supply circuit must be fused in such a way that suitable protection is provided for users and products.
21. Do not insert any objects into the openings in the housing that are not designed for this purpose. Never pour any liquids onto or into the housing. This can cause short circuits inside the product and/or electric shocks, fire or injuries.
22. Use suitable overvoltage protection to ensure that no overvoltage (such as that caused by a thunderstorm) can reach the product. Otherwise the operating personnel will be endangered by electric shocks.
23. Rohde & Schwarz products are not protected against penetration of water, unless otherwise specified (see also safety instruction 1.). If this is not taken into account, there exists the danger of electric shock or damage to the product, which can also lead to personal injury.
24. Never use the product under conditions in which condensation has formed or can form in or on the product, e.g. if the product was moved from a cold to a warm environment.
25. Do not close any slots or openings on the product, since they are necessary for ventilation and prevent the product from overheating. Do not place the product on soft surfaces such as sofas or rugs or inside a closed housing, unless this is well ventilated.
26. Do not place the product on heat-generating devices such as radiators or fan heaters. The temperature of the environment must not exceed the maximum temperature specified in the data sheet.
27. Batteries and storage batteries must not be exposed to high temperatures or fire. Keep batteries and storage batteries away from children. If batteries or storage batteries are improperly replaced, this can cause an explosion (warning: lithium cells). Replace the battery or storage battery only with the matching Rohde & Schwarz type (see spare parts list). Batteries and storage batteries are hazardous waste. Dispose of them only in specially marked containers. Observe local regulations regarding waste disposal. Do not short-circuit batteries or storage batteries.
28. Please be aware that in the event of a fire, toxic substances (gases, liquids etc.) that may be hazardous to your health may escape from the product.
29. Please be aware of the weight of the product. Be careful when moving it; otherwise you may injure your back or other parts of your body.
30. Do not place the product on surfaces, vehicles, cabinets or tables that for reasons of weight or stability are unsuitable for this purpose. Always follow the manufacturer's installation instructions when installing the product and fastening it to objects or structures (e.g. walls and shelves).
31. Handles on the products are designed exclusively for personnel to hold or carry the product. It is therefore not permissible to use handles for fastening the product to or on means of transport such as cranes, fork lifts, wagons, etc. The user is responsible for securely fastening the products to or on the means of transport and for observing the safety regulations of the manufacturer of the means of transport. Noncompliance can result in personal injury or material damage.
32. If you use the product in a vehicle, it is the sole responsibility of the driver to drive the vehicle safely. Adequately secure the product in the vehicle to prevent injuries or other damage in the event of an accident. Never use the product in a moving vehicle if doing so could distract the driver of the vehicle. The driver is always responsible for the safety of the vehicle; the manufacturer assumes no responsibility for accidents or collisions.
33. If a laser product (e.g. a CD/DVD drive) is integrated in a Rohde & Schwarz product, do not use any other settings or functions than those described in the documentation. Otherwise this may be hazardous to your health, since the laser beam can cause irreversible damage to your eyes. Never try to take such products apart, and never look into the laser beam.



Por favor lea imprescindiblemente antes de la primera puesta en funcionamiento las siguientes informaciones de seguridad



Informaciones de seguridad

Es el principio de Rohde & Schwarz de tener a sus productos siempre al día con los estándares de seguridad y de ofrecer a sus clientes el máximo grado de seguridad. Nuestros productos y todos los equipos adicionales son siempre fabricados y examinados según las normas de seguridad vigentes. Nuestra sección de gestión de la seguridad de calidad controla constantemente que sean cumplidas estas normas. Este producto ha sido fabricado y examinado según el comprobante de conformidad adjunto según las normas de la CE y ha salido de nuestra planta en estado impecable según los estándares técnicos de seguridad. Para poder preservar este estado y garantizar un funcionamiento libre de peligros, deberá el usuario atenerse a todas las informaciones, informaciones de seguridad y notas de alerta. Rohde&Schwarz está siempre a su disposición en caso de que tengan preguntas referentes a estas informaciones de seguridad.

Además queda en la responsabilidad del usuario utilizar el producto en la forma debida. Este producto solamente fue elaborado para ser utilizado en la industria y el laboratorio o para fines de campo y de ninguna manera deberá ser utilizado de modo que alguna persona/cosa pueda ser dañada. El uso del producto fuera de sus fines definidos o despreciando las informaciones de seguridad del fabricante queda en la responsabilidad del usuario. El fabricante no se hace en ninguna forma responsable de consecuencias a causa del maluso del producto.

Se parte del uso correcto del producto para los fines definidos si el producto es utilizado dentro de las instrucciones del correspondiente manual del uso y dentro del margen de rendimiento definido (ver hoja de datos, documentación, informaciones de seguridad que siguen). El uso de los productos hace necesarios conocimientos profundos y el conocimiento del idioma inglés. Por eso se deberá tener en cuenta de exclusivamente autorizar para el uso de los productos a personas peritas o debidamente minuciosamente instruidas con los conocimientos citados. Si fuera necesaria indumentaria de seguridad para el uso de productos de R&S, encontrará la información debida en la documentación del producto en el capítulo correspondiente.

Símbolos y definiciones de seguridad

| | | | | | | | |
|-------------------------------------|---|-------------------------------|-----------------------------------|--------------------------------|-------------------|----------------------------|---|
| | | | | | | | |
| Ver manual de instrucciones del uso | Informaciones para maquinaria con un peso de > 18kg | Peligro de golpe de corriente | ¡Advertencia! Superficie caliente | Conexión a conductor protector | Conexión a tierra | Conexión a masa conductora | ¡Cuidado! Elementos de construcción con peligro de carga electrostática |

| | | | | | |
|---------------------------|---------------------|-----------------------|----------------------|----------------------------------|--|
| | | | | | |
| potencia EN MARCHA/PARADA | Indicación Stand-by | Corriente continua DC | Corriente alterna AC | Corriente continua/alterna DC/AC | El aparato está protegido en su totalidad por un aislamiento de doble refuerzo |

Informaciones de seguridad

Tener en cuenta las informaciones de seguridad sirve para tratar de evitar daños y peligros de toda clase. Es necesario de que se lean las siguientes informaciones de seguridad concienzudamente y se tengan en cuenta debidamente antes de la puesta en funcionamiento del producto. También deberán ser tenidas en cuenta las informaciones para la protección de personas que encontrarán en otro capítulo de esta documentación y que también son obligatorias de seguir. En las informaciones de seguridad actuales hemos juntado todos los objetos vendidos por Rohde&Schwarz bajo la denominación de „producto“, entre ellos también aparatos, instalaciones así como toda clase de accesorios.

Palabras de señal y su significado

| | |
|-------------|--|
| PELIGRO | Indica un punto de peligro con gran potencial de riesgo para el usuario. Punto de peligro que puede llevar hasta la muerte o graves heridas. |
| ADVERTENCIA | Indica un punto de peligro con un potencial de riesgo mediano para el usuario. Punto de peligro que puede llevar hasta la muerte o graves heridas . |
| ATENCIÓN | Indica un punto de peligro con un potencial de riesgo pequeño para el usuario. Punto de peligro que puede llevar hasta heridas leves o pequeñas |
| CUIDADO | Indica la posibilidad de utilizar mal el producto y a consecuencia dañarlo. |
| INFORMACIÓN | Indica una situación en la que deberían seguirse las instrucciones en el uso del producto, pero que no consecuentemente deben de llevar a un daño del mismo. |

Las palabras de señal corresponden a la definición habitual para aplicaciones civiles en el ámbito de la comunidad económica europea. Pueden existir definiciones diferentes a esta definición. Por eso se debiera tener en cuenta que las palabras de señal aquí descritas sean utilizadas siempre solamente en combinación con la correspondiente documentación y solamente en combinación con el producto correspondiente. La utilización de las palabras de señal en combinación con productos o documentaciones que no les correspondan puede llevar a malinterpretaciones y tener por consecuencia daños en personas u objetos.

Informaciones de seguridad elementales

1. El producto solamente debe ser utilizado según lo indicado por el fabricante referente a la situación y posición de funcionamiento sin que se obstruya la ventilación. Si no se convino de otra manera, es para los productos R&S válido lo que sigue: como posición de funcionamiento se define principalmente la posición con el suelo de la caja para abajo , modo de protección IP 2X, grado de suciedad 2, categoría de sobrecarga eléctrica 2, utilizar solamente en estancias interiores, utilización hasta 2000 m sobre el nivel del mar.
A menos que se especifique otra cosa en la hoja de datos, se aplicará una tolerancia de $\pm 10\%$ sobre el voltaje nominal y de $\pm 5\%$ sobre la frecuencia nominal.
2. En todos los trabajos deberán ser tenidas en cuenta las normas locales de seguridad de trabajo y de prevención de accidentes. El producto solamente debe de ser abierto por personal périto autorizado. Antes de efectuar trabajos en el producto o abrirlo deberá este ser desconectado de la corriente. El ajuste, el cambio de partes, la manutención y la reparación deberán ser solamente efectuadas por electricistas autorizados por R&S. Si se reponen partes con importancia para los aspectos de seguridad (por ejemplo el enchufe, los transformadores o los fusibles), solamente podrán ser sustituidos por partes originales. Despues de cada recambio de partes elementales para la seguridad deberá ser efectuado un control de

Informaciones de seguridad

- seguridad (control a primera vista, control de conductor protector, medición de resistencia de aislamiento, medición de medición de la corriente conductora, control de funcionamiento).
3. Como en todo producto de fabricación industrial no puede ser excluido en general de que se produzcan al usarlo elementos que puedan generar alergias, los llamados elementos alergénicos (por ejemplo el níquel). Si se produjeran en el trato con productos R&S reacciones alérgicas, como por ejemplo urticaria, estornudos frecuentes, irritación de la conjuntiva o dificultades al respirar, se deberá consultar inmediatamente a un médico para averiguar los motivos de estas reacciones.
 4. Si productos / elementos de construcción son tratados fuera del funcionamiento definido de forma mecánica o térmica, pueden generarse elementos peligrosos (polvos de sustancia de metales pesados como por ejemplo plomo, berilio, níquel). La partición elemental del producto, como por ejemplo sucede en el tratamiento de materias residuales, debe de ser efectuada solamente por personal especializado para estos tratamientos. La partición elemental efectuada inadecuadamente puede generar daños para la salud. Se deben tener en cuenta las directivas nacionales referentes al tratamiento de materias residuales.
 5. En el caso de que se produjeran agentes de peligro o combustibles en la aplicación del producto que debieran de ser transferidos a un tratamiento de materias residuales, como por ejemplo agentes refrigerantes que deben ser repuestos en periodos definidos, o aceites para motores, deberán ser tenidas en cuenta las prescripciones de seguridad del fabricante de estos agentes de peligro o combustibles y las regulaciones regionales para el tratamiento de materias residuales. Cuiden también de tener en cuenta en caso dado las prescripciones de seguridad especiales en la descripción del producto.
 6. Ciertos productos, como por ejemplo las instalaciones de radiación HF, pueden a causa de su función natural, emitir una radiación electromagnética aumentada. En vista a la protección de la vida en desarrollo deberían ser protegidas personas embarazadas debidamente. También las personas con un bypass pueden correr peligro a causa de la radiación electromagnética. El empresario está comprometido a valorar y señalar áreas de trabajo en las que se corra un riesgo de exposición a radiaciones aumentadas de riesgo aumentado para evitar riesgos.
 7. La utilización de los productos requiere instrucciones especiales y una alta concentración en el manejo. Debe de ponerse por seguro de que las personas que manejen los productos estén a la altura de los requerimientos necesarios referente a sus aptitudes físicas, psíquicas y emocionales, ya que de otra manera no se pueden excluir lesiones o daños de objetos. El empresario lleva la responsabilidad de seleccionar el personal usuario apto para el manejo de los productos.
 8. Antes de la puesta en marcha del producto se deberá tener por seguro de que la tensión preseleccionada en el producto equivalga a la del la red de distribución. Si es necesario cambiar la preselección de la tensión también se deberán en caso dabo cambiar los fusibles correspondientes del producto.
 9. Productos de la clase de seguridad I con alimentación móvil y enchufe individual de producto solamente deberán ser conectados para el funcionamiento a tomas de corriente de contacto de seguridad y con conductor protector conectado.
 10. Queda prohibida toda clase de interrupción intencionada del conductor protector, tanto en la toma de corriente como en el mismo producto ya que puede tener como consecuencia el peligro de golpe de corriente por el producto. Si se utilizaran cables o enchufes de extensión se deberá poner al seguro, que es controlado su estado técnico de seguridad.
 11. Si el producto no está equipado con un interruptor para desconectarlo de la red, se deberá considerar el enchufe del cable de distribución como interruptor. En estos casos deberá asegurar de que el enchufe sea de fácil acceso y nabejo (medida del cable de distribución aproximadamente 2 m). Los interruptores de función o electrónicos no son aptos para el corte de la red eléctrica. Si los productos sin interruptor están integrados en construcciones o instalaciones, se deberá instalar el interruptor al nivel de la instalación.

Informaciones de seguridad

12. No utilice nunca el producto si está dañado el cable eléctrico. Asegure a través de las medidas de protección y de instalación adecuadas de que el cable de eléctrico no pueda ser dañado o de que nadie pueda ser dañado por él, por ejemplo al tropezar o por un golpe de corriente.
13. Solamente está permitido el funcionamiento en redes de distribución TN/TT aseguradas con fusibles de como máximo 16 A.
14. Nunca conecte el enchufe en tomas de corriente sucias o llenas de polvo. Introduzca el enchufe por completo y fuertemente en la toma de corriente. Si no tiene en consideración estas indicaciones se arriesga a que se originen chispas, fuego y/o heridas.
15. No sobrecargue las tomas de corriente, los cables de extensión o los enchufes de extensión ya que esto pudiera causar fuego o golpes de corriente.
16. En las mediciones en circuitos de corriente con una tensión de entrada de $U_{eff} > 30 \text{ V}$ se deberá tomar las precauciones debidas para impedir cualquier peligro (por ejemplo medios de medición adecuados, seguros, limitación de tensión, corte protector, aislamiento etc.).
17. En caso de conexión con aparatos de la técnica informática se deberá tener en cuenta que estos cumplan los requisitos de la EC950/EN60950.
18. Nunca abra la tapa o parte de ella si el producto está en funcionamiento. Esto pone a descubierto los cables y componentes eléctricos y puede causar heridas, fuego o daños en el producto.
19. Si un producto es instalado fijamente en un lugar, se deberá primero conectar el conductor protector fijo con el conductor protector del aparato antes de hacer cualquier otra conexión. La instalación y la conexión deberán ser efectuadas por un electricista especializado.
20. En caso de que los productos que son instalados fijamente en un lugar sean sin protector implementado, autointerruptor o similares objetos de protección, deberá la toma de corriente estar protegida de manera que los productos o los usuarios estén suficientemente protegidos.
21. Por favor, no introduzca ningún objeto que no esté destinado a ello en los orificios de la caja del aparato. No vierta nunca ninguna clase de líquidos sobre o en la caja. Esto puede producir corto circuitos en el producto y/o puede causar golpes de corriente, fuego o heridas.
22. Asegúrese con la protección adecuada de que no pueda originarse en el producto una sobrecarga por ejemplo a causa de una tormenta. Si no se verá el personal que lo utilice expuesto al peligro de un golpe de corriente.
23. Los productos R&S no están protegidos contra el agua si no es que exista otra indicación, ver también punto 1. Si no se tiene en cuenta esto se arriesga el peligro de golpe de corriente o de daños en el producto lo cual también puede llevar al peligro de personas.
24. No utilice el producto bajo condiciones en las que pueda producirse y se hayan producido líquidos de condensación en o dentro del producto como por ejemplo cuando se desplaza el producto de un lugar frío a un lugar caliente.
25. Por favor no cierre ninguna ranura u orificio del producto, ya que estas son necesarias para la ventilación e impiden que el producto se caliente demasiado. No pongan el producto encima de materiales blandos como por ejemplo sofás o alfombras o dentro de una caja cerrada, si esta no está suficientemente ventilada.
26. No ponga el producto sobre aparatos que produzcan calor, como por ejemplo radiadores o calentadores. La temperatura ambiental no debe superar la temperatura máxima especificada en la hoja de datos.

Informaciones de seguridad

27. Baterías y acumuladores no deben de ser expuestos a temperaturas altas o al fuego. Guardar baterías y acumuladores fuera del alcance de los niños. Si las baterías o los acumuladores no son cambiados con la debida atención existirá peligro de explosión (atención celulas de Litio). Cambiar las baterías o los acumuladores solamente por los del tipo R&S correspondiente (ver lista de piezas de recambio). Baterías y acumuladores son deshechos problemáticos. Por favor tirenlos en los recipientes especiales para este fin. Por favor tengan en cuenta las prescripciones nacionales de cada país referente al tratamiento de deshechos. Nunca sometan las baterías o acumuladores a un corto circuito.
28. Tengan en consideración de que en caso de un incendio pueden escaparse gases tóxicos del producto, que pueden causar daños a la salud.
29. Por favor tengan en cuenta que en caso de un incendio pueden desprenderse del producto agentes venenosos (gases, líquidos etc.) que pueden generar daños a la salud.
30. No sitúe el producto encima de superficies, vehículos, estantes o mesas, que por sus características de peso o de estabilidad no sean aptas para él. Siga siempre las instrucciones de instalación del fabricante cuando instale y asegure el producto en objetos o estructuras (por ejemplo paredes y estantes).
31. Las asas instaladas en los productos sirven solamente de ayuda para el manejo que solamente está previsto para personas. Por eso no está permitido utilizar las asas para la sujecion en o sobre medios de transporte como por ejemplo grúas, carretillas elevadoras de horquilla, carros etc. El usuario es responsable de que los productos sean sujetados de forma segura a los medios de transporte y de que las prescripciones de seguridad del fabricante de los medios de transporte sean tenidas en cuenta. En caso de que no se tengan en cuenta pueden causarse daños en personas y objetos.
32. Si llega a utilizar el producto dentro de un vehículo, queda en la responsabilidad absoluta del conductor que conducir el vehículo de manera segura. Asegure el producto dentro del vehículo debidamente para evitar en caso de un accidente las lesiones u otra clase de daños. No utilice nunca el producto dentro de un vehículo en movimiento si esto pudiera distraer al conductor. Siempre queda en la responsabilidad absoluta del conductor la seguridad del vehículo y el fabricante no asumirá ninguna clase de responsabilidad por accidentes o colisiones.
33. Dado el caso de que esté integrado un producto de laser en un producto R&S (por ejemplo CD/DVD-ROM) no utilice otras instalaciones o funciones que las descritas en la documentación. De otra manera pondrá en peligro su salud, ya que el rayo laser puede dañar irreversiblemente sus ojos. Nunca trate de descomponer estos productos. Nunca mire dentro del rayo laser.

Supplement A to Operating Manual Spectrum Analyzer FSEA20/30, FSEB20/30, FSEM20/21/30/31, FSEK20/21/30/31

(Firmware Version 3.30 and higher (for instruments without controller function or with DOS controller function))

(Firmware Version 4.30 and higher (for instruments with Windows NT controller function))

Dear Customer,

your spectrum analyzer is equipped with a new firmware version. The new firmware offers a number of extensions and improvements which are not yet described in the operating manual. They are explained on the following pages. The new functions concern:

- Selection of trace averaging method
- Extended functionality for external mixer (option FSE-B21)
- Extended functionality for operating modes GSM BTS ANALYZER (FSE-K11) and GSM MS ANALYZER (FSE-K10).
- New operating mode EDGE Mobile Tests (application firmware FSE-K20).
- New operating mode EDGE Base Station Tests (application firmware FSE-K21).
- New application firmware extension FSE-K30: 850 MHz GSM band for FSE-K10 and FSE-K20
- New application firmware extension FSE-K31: 850 MHz GSM band for FSE-K11 and FSE-K21
- Extended functionality for operating mode vector signal analysis (option FSE-B7)
- Trace export in vector analyzer mode
- Additional IEEE/IEC-bus commands



Caution:

Instruments FSEM and FSEK equipped with a RF module of model index 20 and higher should not be operated by a firmware version below 3.01 or 4.01 (instruments with Windows NT controller).

Selection of Trace Averaging Method

Section "Trace Selection and Setup" of the operating manual was extended to include the selection of the trace averaging method.

TRACE 1 right side menu:



The *AVERAGE LIN/LOG* softkey switches between linear and logarithmic averaging in case of logarithmic level display.

In case of logarithmic averaging, the dB values of the display voltage are averaged, in case of linear averaging the level values in dB are converted into linear voltages or powers prior to averaging. These voltages or powers are averaged and then again converted into level values.

For stationary sinewave signals the two averaging methods yield the same result.

Logarithmic averaging is recommended if sinewave signals are to clearly stand out against the noise since, with this averaging, noise suppression is greater while the sinewave signals remain unchanged.

IEC/IEEE command : [SENSE<1 | 2> :]AVERAge:TYPE VIDEo | LINear

This softkey is also available for GSM application firmware FSE-K10/K11 in Power vs Time and Carrier Power measurements.

External Mixer option FSE-B21 extended

The permissible setting range of parameter *HARMONIC NUMBER* under *BAND LOCK OFF* was increased from 40 to 62.

New Application Firmware FSE-K20/21, EDGE Mobile Tests and EDGE Base Station Tests.

Firmware application FSE-K20 (order no. 1106.4086.02) extends option FSE-K10 and firmware application FSE-K21 (order no.1106.4186.02) extends option FSE-K11 by the analysis of 8-PSK modulated EDGE signals according to the standard.

In this way, the functions of firmware applications FSE-K10 and FSE-K11 is also available for EDGE signals.

The functions of the options are described in the following manuals:

Operating Manual EDGE Mobile Tests FSE-K20, Order No. 1106.4105.xx-01

where xx = 41 (German)
42 (English)
49 (English, US letter format)

Operating Manual EDGE Base Station Tests FSE-K21, Order No. 1106.4205.xx-01

where xx = 41 (German)
42 (English)
49 (English, US letter format)

New Application Firmware Extensions FSE-K30 and FSE-K31 for Operating Modes GSM and EDGE Mobile and Base Station Tests

FW extension FSE-K30/FSE-K31 provides measurements in the new 850 MHz GSM band for firmware applications FSE-K10/FSE-K20 or FSE-K11/FSE-K21.

Extended Functionality for Vector Analyzer Operating Mode (Option FSE-B7)

Adaptation for EDGE - measurement with receiver filter

The EDGE measurement with a receiver filter and the EVM calculation are performed according to ETSI-TDOC **SMG2 829/99** / ANNEX H. This specified filter is effective in all display and measurement modes. Since it is a lowpass filter intersymbol-interference-free (ISI-free) points no longer occur in the display modes such as constellation diagram and vector diagram. In addition, the sync sequences provided in the unit were adapted by inverting the bits.

Note: If measurements are to be performed without a receiver filter, deactivate digital standard EDGE (e.g. by switching from modulation parameter, meas filter from edge_mes to egde_ref and back to edge_mes).

Analog Demodulation - THD Measurement

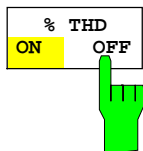
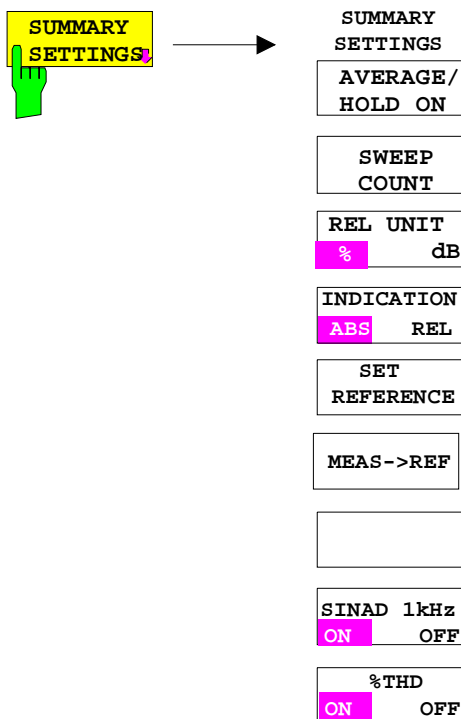

REAL TIME ON only.

The **%THD ON/OFF** softkey activates the %THD measurement (= similar to SINAD measurement, but result displayed in %) for the main modulation signal.

Irrespective of the signal applied, the main modulation signal is compared with the main modulation signal which is filtered by a 1-kHz notch filter. The display unit is %.

When a signal modulated with 1 kHz is applied, the %THD value is thus displayed correctly.

Default setting is **%THD OFF**.

With **REAL TIME OFF** (no real-time demodulation) no **%THD** measurement is possible, the softkey cannot be operated.

IEC/IEEE-bus command: :CALC:MARK:FUNC:ADEM:SIN:THD[:STAT] ON
:CALC:MARK:FUNC:ADEM:SIN:RES?

Trace Export for VECTOR ANALYZER Mode

Section "Measurement Function Selection – TRACE 1 to 4 Key" has been extended for the function ASCII EXPORT.



In vector analyzer mode, the *ASCII EXPORT* softkey stores the corresponding trace in a file with ASCII format. For measurement results that are output in written text in tables (Symbol Table, Error Summary, Modulation Summary), this function is not available.

Upon pressing the ASCII EXPORT softkey, a file name can be entered. The default name is TRACE.DAT. Then the measured data of the trace are stored.

The function can be configured in the *ASCII CONFIG* submenu (see trace export for analyzer mode)

Structure of the ASCII file:

The file consists of the header containing important measurement and scaling parameters and a data section containing the trace data.

The data of the file header consist of three columns, each separated by a semicolon:

parameter name; numeric value; basic unit

The data section starts with the keyword " Trace <n> " (<n> = number of stored trace), followed by the measured data in one or several columns (depending on measurement) which are also separated by a semicolon.

This format can be read in from spreadsheet calculation programs, e.g. MS-Excel. It is necessary to define ';' as a separator.

1) Format for digital demodulation

| | Content of file | Description |
|----------------------|--|---|
| File header | Type;FSEA 30; | Instrument model |
| | Version;3.10; | Firmware version |
| | Date;01.Oct 2000; | Date of data set storage |
| | Comment;Test 1; | Comment |
| | Mode;digital demodulation; | Instrument mode |
| | Signal;Meas Signal; | Signal: Measurement, reference or error signal |
| | Measurement;PHASE; | Selected measurement |
| | Digital Standard;GSM; | Selected digital standard |
| | Demodulator;DMSK; | Selected demodulation type |
| | Center Freq;1930200000;Hz | Center frequency |
| | Freq Offset;0;Hz | Frequency offset |
| | Ref.Level;-30;dBm | Reference level |
| | Level Offset;0;dB | Level offset |
| | RF Att;20;dB | Input attenuator |
| | Symbol Rate;270833.33;Hz | Symbol rate |
| | Meas Filter;NONE; | Input filter |
| | Ref Filter;gauss; | Filter for ideal reference signal |
| | Alpha BT;0.3000000; | Roll Off factor or product of bandwidth/symbol duration |
| | Result Length;148;Symbols | Number of indicated symbols |
| | Frame Length;400;Symbols | Number of evaluated symbols |
| | Points per Symbol;4; | Points per symbol |
| | Memory Size;16384; | Memory size |
| | x-Axis Start;0.0;Symbols; | Start value of x axis |
| | x-Axis Stop;147.75;Symbols; | Stop value of x axis |
| | y per div;45.0;deg; | Y axis scaling, per division |
| | Ref Value y-Axis;0.0;deg; | y axis scaling, reference value |
| | Ref Value Position;50.0;%; | y axis scaling, position of reference value |
| Sweep Count;20; | Number of sweeps | |
| Trace Mode;CLR/WRITE | Trace mode: CLR/WRITE,AVERAGE,MAXHOLD,MINHOLD | |

| | Content of file | Description |
|---------------------------------|---|---|
| Data section of the file | Trace 1: x-Unit;Symbols; y-Unit;deg; Values;592; | Selected trace Unit of x values: Unit of y values: Number of test points Measured values: |
| | 0.00;44.919303894; 0.25;35.109680176; 0.50;31.512094498; 0.75;36.470279694; 1.00;49.823390961; ...;... | <x value>,, <y1>, <y2> <y2> being only available with Polar Vector or Polar Constellation. |

Example 1a: GSM Phase Measurement

```
Type;FSEA 30;
Version;3.10;
Date;13.Jul 2001;
Comment;PCS BTS;
Mode;digital demodulation;
Signal;Meas Signal;
Measurement;PHASE;
Digital Standard;GSM;
Demodulator;DMSK;
Center Freq;1930200000.000000;Hz;
Freq Offset;0.000000;Hz;
Ref. Level;-10.000000;dBm;
Level Offset;0.000000;dB;
RF Att;20.000000;dB;
Symbol Rate;270833.333330;Hz;
Meas Filter;NONE;
Ref Filter;gauss;
Alpha BT;0.300000;
Result Length;148;Symbols;
Frame Length;400;Symbols;
Points per Symbol;4;
Memory Size;16384;
x-Axis Start;0.000000;Symbols;
x-Axis Stop;147.750000;Symbols;
y per div;45.000000000;deg;
Ref Value y-Axis;0.000000;deg;
Ref Value Position;50.000000;%;
Sweep Count;0;
Trace Mode;CLR/WRITE;
TRACE 1:
x-Unit;Symbols;
y-Unit;deg;
Values;592;
0.000000;44.919303894;
0.250000;35.109680176;
0.500000;31.512094498;
0.750000;36.470279694;
1.000000;49.823390961;
```

...

Example 1b: Polar Vector Measurement

```
Type;FSEA 30;
Version;3.10;
Date;13.Jul 2001;
Comment;;
Mode;digital demodulation;
Signal;Error Signal;
Measurement;IQ POLAR VECTOR;
Digital Standard;None;
Demodulator;DMSK;
Center Freq;1930200000.000000;Hz;
Freq Offset;0.000000;Hz;
Ref. Level;-10.000000;dBm;
Level Offset;0.000000;dB;
RF Att;20.000000;dB;
Symbol Rate;270833.333330;Hz;
Meas Filter;NONE;
Ref Filter;raised cos;
Alpha BT;0.300000;
Result Length;148;Symbols;
Frame Length;400;Symbols;
Points per Symbol;4;
Memory Size;16384;
x-Axis Start;-12.500000;NONE;
x-Axis Stop;12.500000;NONE;
y per div;2.0000000000;%;
Ref Value y-Axis;0.000000;%;
Ref Value Position;50.000000;%;
Sweep Count;0;
Trace Mode;CLR/WRITE;
TRACE 1:
x-Unit;NONE;
y-Unit;%;
Values;592;
0.000000;-1.167166233;0.299441814;
0.250000;7.433214664;5.665826797;
0.500000;16.573915482;9.026193619;
0.750000;22.309810638;12.612837791;
1.000000;19.233440399;17.377298355;
...
```

2) Format for analog demodulation

| | Content of file | Description |
|---------------------------------|--|---|
| File header | Type;FSEA 30; | Instrument model |
| | Version;3.10; | Firmware version |
| | Date;13.Jul 2001; | Date of data set storage |
| | Comment;Test 1; | Comment |
| | Mode;analog demodulation; | Instrument mode |
| | Signal;AF Signal; | AF mode |
| | Measurement;AM Signal; | Type of demodulation (AM, FM, PM) |
| | Coupling;AC COUPLING; | AC or DC coupling |
| | Real Time;OFF; | Real time demodulation (on/off) |
| | Center Freq;930200000;Hz; | Center frequency |
| | Freq Offset;0.000000;Hz; | Frequency offset |
| | Ref. Level;-10.000000;dBm; | Reference level |
| | Level Offset;0.000000;dB; | Level offset |
| | RF Att;20.000000;dB; | Input attenuation |
| | Demod BW;100000.000000;Hz; | Demodulation bandwidth |
| | x-Axis Start;0.000000;s; | Start value of x axis |
| | x-Axis Stop;0.005000000;s; | Stop value of x axis |
| | y per div;50.0;%; | Y axis scaling, per division |
| | Ref Value y-Axis;0.0;%; | Y axis scaling, reference value |
| | Ref Value Position;50.0;%; | Y axis scaling, position of reference value |
| Sweep Count;0; | Number of sweeps set | |
| Trace Mode;CLR/WRITE; | Trace mode: CLR/WRITE,AVERAGE,MAXHOLD,MINHOLD | |
| Data section of the file | Trace 1: | Selected trace |
| | x-Unit;s; | Unit of x values |
| | y-Unit;%; | Unit of y values |
| | Values;625; | Number of test points |
| | 0.0;-28.4; | Measured values: <x value>; <y value>; |
| | 0.008e-003;-28.4; | |
| | 0.016e-003;-28.5; | |
| | 0.024e-003;-28.5; | |
| | 0.032e-003;-28.4; | |
| | ...;...; | |

Example 2: Analog Demodulation

```
Type;FSEA 30;
Version;3.10;
Date;13.Jul 2001;
Comment;Test 1;
Mode;analog demodulation;
Signal;AF Signal;
Measurement;AM Signal;
Coupling;AC COUPLING;
Real Time;OFF;
Center Freq;1930200000.000000;Hz;
Freq Offset;0.000000;Hz;
Ref. Level;-10.000000;dBm;
Level Offset;0.000000;dB;
RF Att;20.000000;dB;
Demod BW;100000.000000;Hz;
x-Axis Start;0.000000;s;
x-Axis Stop;0.005000000;s;
y per div;50.000000000;%;
Ref Value y-Axis;0.000000;%;
Ref Value Position;50.000000;%;
Sweep Count;0;
Trace Mode;CLR/WRITE;
TRACE 1:
x-Unit;s;
y-Unit;%;
Values;625;
0.000000;-28.418941498;
0.008012821e-003;-28.434963226;
0.016025641e-003;-28.550777435;
0.024038462e-003;-28.536586761;
0.032051282e-003;-28.461055756;
```

Extended Functionality for GSM BTS ANALYZER and GSM MS ANALYZER Operating Modes

Functions for the GSM BTS ANALYZER and GSM MS ANALYZER modes have been considerably extended:

- Additional power class P1 for GSM BTS Analyzer. The new power class P1 for Pico BTS is supported.
- Extended settings range of output power for GSM BTS Analyzer
The settings range of output power now includes the gap between the power classes 8 and M1. Settings in this range are indicated by a question mark "?" in the table of power classes.
- Trace averaging mode selectable (see description above for Analyzer mode).

Note for Option FSE-K10:

The measurement MODULATION SPECTRUM - RX BAND as specified in GSM-11.10, chapter 13.4.4, section d)

d) The resolution and video bandwidth on the spectrum analyzer are adjusted to 100 kHz and the measurements are made at the following frequencies:

on every ARFCN from 1 800 kHz offset from the carrier to the edge of the relevant transmit band for each measurement over 50 bursts.

at 200 kHz intervals over the 2 MHz either side of the relevant transmit band for each measurement over 50 bursts.

at 200 kHz intervals over the band 925 - 960 MHz for each measurement over 50 bursts.

at 200 kHz intervals over the band 1805 - 1880 MHz for each measurement over 50 bursts.

covers also for the P-GSM the E-GSM RX band.

For firmware release 3.10 / 4.10 and above, the measurement covers the following bands:

| Selected standard | Modulation RX bands |
|---|---|
| P-GSM | 925 – 960 MHz (instead of 935 to 960 MHz as before) |
| E-GSM | 925 – 960 MHz |
| For RGSM the extended range from 921 MHz is used. | |
| R-GSM | 921 – 960 MHz |

New IEEE-Bus Commands

The new firmware was extended by the following IEEE-bus commands:

- %THD measurement (FSE-B7, analog demodulation).
- Query for currently used limits in operating modes GSM BTS ANALYZER (FSE-K11) and GSM MS ANALYZER (FSE-K10), Phase Frequency Error measurement.
- Query for currently used limits in FSE-K20/K21 Modulation Accuracy measurement.
- Trace averaging method selectable.

New or extended commands for option FSE-B7 and firmware applications FSE-K10, FSE-K11, FSE-K20, FSE-K21, FSE-K30 and FSE-K31 are included in the updated FSE operating manual and therefore not described in this supplement.

The commands are listed in alphabetical order. In the individual description, the complete notation of the command is given. An example for each command, the *RST value and the SCPI information is written out at the end of the individual description. The modes for which a command can be used are indicated by the following abbreviations:

| | |
|------|---|
| A | Spectrum analysis |
| A-F | Spectrum analysis - frequency domain only |
| A-Z | Spectrum analysis - time domain only (zero span) |
| VA | Vector signal analysis (option FSE-B7) |
| VA-D | Vector signal analysis - digital demodulation (option FSE-B7) |
| VA-A | Vector signal analysis - analog demodulation (option FSE-B7) |
| BTS | GSM BTS analysis (options FSE-K11, FSE-K21, FSE-K31) |
| MS | GSM MS analysis (options FSE-K10, FSE-K20, FSE-K30) |

Note: *The spectrum analysis (analyzer) mode is implemented in the basic unit. For the other modes, the corresponding options are required.*

:CALCulate<1|2>:MARKer<1...4>:FUNCTION:ADEMod:SINad:RESult?

This command queries the results of the SINAD or of the THD measurement. For SINAD the result is given in dB, for THD in percent.

Example: " :CALC:MARK:FUNC:ADEM:SIN:RES? "

Features: *RST-Value: -
SCPI: device-specific

Mode: VA-A

This command is only a query which is why it is not assigned an *RST value.

:CALCulate<1|2>:MARKer<1...4>:FUNCTION:ADEMod:SINad:THD[:STATe] ON | OFF

This command switches the THD measurement on or off. SINAD and THD can not be active at the same time. The result is queried with the same command as the result of the SINAD measurement (see above).

Example: " :CALC:MARK:FUNC:ADEM:SIN:THD ON "

Features: *RST-Value: OFF
SCPI: device-specific

Mode: VA-A

This command is valid only in the analog demodulation mode with Real Time ON.

Modification of Commands for GSM/EDGE Applications:

:CONFigure[:BTS]:LIMit:PPEak <numeric_value>

This command determines the phase error limits in degrees for the phase/frequency measurement (peak value).

Example: " :CONF:LIM:PPE 66 "

Features: *RST value: depends on selected standard
SCPI: device specific

Mode: BTS

For firmware 3.20/4.20 and higher, the query :CONFigure[:BTS]:LIMit:PPEak? reads out the error limits currently used in the measurement. I.e., if the standard limits are used, these limits are read out, and if the user limits are used, the set user limits are read out. For firmware versions < 3.20/4.20, always the user limits were read out even if the standards limits were used.

This modification also applies to the following commands:

:CONFigure[:BTS]:LIMit:PRMS

:CONFigure[:BTS]:LIMit:EVMRms

:CONFigure[:BTS]:LIMit:EVMPeak

:CONFigure[:BTS]:LIMit:OSUPpress

:CONFigure[:BTS]:LIMit:PERCentile

:CONFigure[:BTS]:LIMit:FREQuency

:CONFigure[:MS]:LIMit:PPEak

:CONFigure[:MS]:LIMit:PRMS

:CONFigure[:MS]:LIMit:EVMRms

:CONFigure[:MS]:LIMit:EVMPeak

:CONFigure[:MS]:LIMit:OSUPpress

:CONFigure[:MS]:LIMit:PERCentile

:CONFigure[:MS]:LIMit:FREQuency

Correction of the Operating Manual:

For the following commands, the correct *RST value is given below:

:CONFigure[:BTS]:NETWork:PHASe
:CONFigure[:MS]:NETWork:PHASe

These commands select the phase of the standard according to which the base/mobile station will work.

Example: " :CONF:NETW:PHAS 2"

Features: *RST value: 2 for PGSM, EGSM, GSM1800
2,PLUS for RGSM
for GSM850 and GSM1900 no phases are available
SCPI: device-specific

Mode: BTS/MS

Extended Functionality:

:[SENSe<1|2>]:AVERAge:TYPE MAXimum | MINimum | SCALar | VIDeo | LINear

This command selects the trace averaging method.

VIDeo Averaging of logarithmic level values.

LINear Averaging of linear power values prior to their conversion into level values.

Example: " :AVER:TYPE LIN"

Features: *RST value: VIDeo
SCPI: device-specific

Mode: A, VA, BTS, MS ("VIDeo" and "LINear" are not available in VA mode)

Note: *It is also possible to select the evaluation mode (MAXimum, MINimum, SCALar) for the trace with this command. However, it is recommended to use command DISPLAY[:WINDow<1|2>]:TRACe<1...4>:MODE for this purpose. The command AVERAge:TYPE should be used only to select the trace averaging method. Also, the query reads out the trace averaging mode only.*

The following functions are defined but should not be used:

MAXimum (MAX HOLD): $AVG(n) = MAX(X_1...X_n)$

MINimum (MIN HOLD): $AVG(n) = MIN(X_1...X_n)$

SCALar (AVERAGE): $AVG(n) = \frac{1}{n} \times \sum_{i=1}^n x_i$

Using user-defined limit lines via the remote-control interface with options GSM BTS ANALYZER and GSM MS ANALYZER, Options FSE-K10 and FSE-K11

If user-defined limit lines are to be remote-controlled in applications K10/K11, the following should be observed:

- Limit lines can be created with the commands of the basic unit (CALC:LIM subsystem). Lines created in such a way are available as limit line files in the unit and cannot be distinguished from the "normal" limit lines.
- A user-defined limit line should meet certain criteria (example: Frequency Domain should be selected for the transient spectrum measurement of K11) so that it can be used for a specific K10/K11 measurement. If an attempt is made to activate a non-compatible line, the unit returns the error message "-221, settings conflict".
- K10/K11 measurements require either no limit line or one (spurious, transient spectrum, modulation spectrum) or two limit lines (power vs time measurement). To ensure that measurements are performed as expected, select and activate at least the required number of limit lines (commands CALC1:LIM1:NAM and CALC1:LIM1:STATE) when using user-defined limit lines. It is not possible to activate a user-defined limit line, e.g. in the power vs time measurement, and then assume that the application will automatically select the second line to standard.
- Suffix 1 is always to be used for measurements with one line: CALC1:LIM1!
- For measurements with two lines, suffix 1 is to be used for lower limits and suffix 2 for upper limits.
- After selection and activation of the required number of limit lines, it is possible to activate the use of user-defined lines with command CONF:BTS:LIM:STAN OFF (K11) or CONF:MS:LIM:STAN OFF (K10).
- It is recommended not to use the names of lines for the limit line standard (e.g. DC_BNL and DC_BNU) as names of user-defined limit lines in order to make the query of limit line characteristics unambiguous.

Programming Example:

A Comment line starts with </>

```
// Start FSE-K11 (e.g. GSM1800, Phase 1).
CONF:BTS:NETW GSM1800
CONF:BTS:NETW:PHAS 1

//Select Power vs. Time (PVT) measurement and perform measurement
//with standard limit lines; query results
CONF:BURS:PTEM
INIT:CONT OFF

INIT
*OPC?
CALC:LIM:BURS:PTEM?
```

```

//Create two limit lines and use them for measurement.

// Upper Limit for PVT

CALC1:LIM1:NAM 'K1PVTU'
CALC1:LIM1:DEL
CALC1:LIM1:UNIT DBM
CALC1:LIM1:CONT:DOM TIME
CALC1:LIM1:CONT:MODE REL
CALC1:LIM1:CONT -400e-6,-300e-6,-200e-6,-100e-6,100e-6,200e-6,300e-6,400e-6
CALC1:LIM1:UPPER -50,-40,-30,-20,-20,-30,-40,-50
CALC1:LIM1:UPPER:MODE ABS

// Lower Limit for PVT

CALC1:LIM1:NAM 'K1PVTL'
CALC1:LIM1:DEL
CALC1:LIM1:UNIT DBM
CALC1:LIM1:CONT:DOM TIME
CALC1:LIM1:CONT:MODE REL
CALC1:LIM1:CONT -400e-6,-300e-6,-200e-6,-100e-6,100e-6,200e-6,300e-6,400e-6
CALC1:LIM1:LOWER -60,-50,-40,-30,-30,-40,-50,-60
CALC1:LIM1:LOWER:MODE ABS

// Switch on and activate user defined limit lines
// The command for switching off the standard limit line is only available
// after the user defined limit lines are switched on

// Index 1 for Lower Limit !
CALC1:LIM1:NAM 'K1PVTL'
// Index 2 for Upper Limit !
CALC1:LIM2:NAM 'K1PVTU'
CALC1:LIM1:STATE ON
CALC1:LIM2:STATE ON
CONF:BTS:LIM:STAN OFF

// Start new measurement and query results
INIT
*OPC?
CALC:LIM:BURS:PTEM?

```

Certified Quality System

DIN EN ISO 9001 : 2000
DIN EN 9100 : 2003
DIN EN ISO 14001 : 1996

DQS REG. NO 001954 QM/ST UM

QUALITÄTSZERTIFIKAT

Sehr geehrter Kunde,

Sie haben sich für den Kauf eines Rohde & Schwarz-Produktes entschieden. Hiermit erhalten Sie ein nach modernsten Fertigungsmethoden hergestelltes Produkt. Es wurde nach den Regeln unseres Managementsystems entwickelt, gefertigt und geprüft.

Das Rohde & Schwarz Managementsystem ist zertifiziert nach:

DIN EN ISO 9001:2000
DIN EN 9100:2003
DIN EN ISO 14001:1996

CERTIFICATE OF QUALITY

Dear Customer,

you have decided to buy a Rohde & Schwarz product. You are thus assured of receiving a product that is manufactured using the most modern methods available. This product was developed, manufactured and tested in compliance with our quality management system standards.

The Rohde & Schwarz quality management system is certified according to:

DIN EN ISO 9001:2000
DIN EN 9100:2003
DIN EN ISO 14001:1996

CERTIFICAT DE QUALITÉ

Cher Client,

vous avez choisi d'acheter un produit Rohde & Schwarz. Vous disposez donc d'un produit fabriqué d'après les méthodes les plus avancées. Le développement, la fabrication et les tests respectent nos normes de gestion qualité.

Le système de gestion qualité de Rohde & Schwarz a été homologué conformément aux normes:

DIN EN ISO 9001:2000
DIN EN 9100:2003
DIN EN ISO 14001:1996



ROHDE & SCHWARZ



Certificate No.: 9502002

This is to certify that:

| Equipment type | Order No. | Designation |
|----------------|--------------------------|-------------------|
| FSEA20/30 | 1065.6000.20/.25/.30/.35 | Spectrum Analyzer |
| FSEB20/30 | 1066.3010.20/.25/.30/.35 | |
| FSEK20/21 | 1088.1491.20/.21/.25 | |
| FSEK30/31 | 1088.3494.30/.31/.35 | |
| FSEM20/21 | 1080.1505.20/.21/.25 | |
| FSEM30/31 | 1079.8500.30/.31/.35 | |

complies with the provisions of the Directive of the Council of the European Union on the approximation of the laws of the Member States

- relating to electrical equipment for use within defined voltage limits
(73/23/EEC revised by 93/68/EEC)
- relating to electromagnetic compatibility
(89/336/EEC revised by 91/263/EEC, 92/31/EEC, 93/68/EEC)

Conformity is proven by compliance with the following standards:

EN61010-1 : 1991
EN55011 : 1998 + A1 : 1999, Klasse B
EN61000-3-2 : 1995 + A1 : 1998 + A2 : 1998 + A14 : 2000
EN61000-3-3 : 1995
EN50082-1 : 1992

Affixing the EC conformity mark as from 1995

ROHDE & SCHWARZ GmbH & Co. KG
Mühldorfstr. 15, D-81671 München

Munich, 2001-01-11

Central Quality Management FS-QZ / Becker



Certificate No.: 9502052

This is to certify that:

| Equipment type | Stock No. | Designation |
|----------------|----------------------|---------------------------------|
| FSE-B1 | 1073.4990.02 | Color Display |
| FSE-B10 | 1066.4769.02 | Tracking Generator |
| FSE-B11 | 1066.4917.02 | Tracking Generator |
| FSE-B12 | 1066.5065.02 | Output Attenuator |
| FSE-B13 | 1119.6499.02 | 1 dB Input Attenuator |
| FSE-B15 | 1073.5696.02/.03 | Computer Function |
| FSE-B16 | 1073.5973.02/.03/.04 | Ethernet Interface |
| FSE-B17 | 1066.4017.02 | 2nd IEC BUS Interface |
| FSE-B18 | 1088.6993.02 | Removeable Harddrive |
| FSE-B19 | 1088.7248.xx | Second Harddisk |
| FSE-B2 | 1073.5044.02 | 7 GHz Frequency Extension |
| FSE-B21 | 1084.7243.02 | External Mixer Output |
| FSE-B23 | 1088.7348.02 | 741,4 MHz Broadband Output |
| FSE-B24 | 1106.3680.02 | 44 GHz Frequency Extension |
| FSE-B3 | 1073.5244.02 | TV Demodulator |
| FSE-B4 | 1073.5396.02 | OCXO 10 MHz and Low Phase Noise |
| FSE-B7 | 1066.4317.02 | Signal Vectoranalysis |
| FSE-B77 | 1102.8493.02 | Signal Vectoranalysis |
| FSE-B8 | 1066.4469.02 | Tracking Generator |
| FSE-B9 | 1066.4617.02 | Tracking Generator |
| FSE-Z2 | 1084.7043.02 | PS/2 Mouse |

complies with the provisions of the Directive of the Council of the European Union on the approximation of the laws of the Member States

- relating to electromagnetic compatibility
(89/336/EEC revised by 91/263/EEC, 92/31/EEC, 93/68/EEC)

Conformity is proven by compliance with the following standards:

EN55011 : 1998 + A1 : 1999, Klasse B
EN61000-3-2 : 1995 + A1 : 1998 + A2 : 1998 + A14 : 2000
EN61000-3-3 : 1995
EN50082-1 : 1992

Affixing the EC conformity mark as from 1995

ROHDE & SCHWARZ GmbH & Co. KG
Mühldorfstr. 15, D-81671 München

Munich, 2001-01-11

Central Quality Management FS-QZ / Becker

Customer Support

Technical support – where and when you need it

For quick, expert help with any Rohde & Schwarz equipment, contact one of our Customer Support Centers. A team of highly qualified engineers provides telephone support and will work with you to find a solution to your query on any aspect of the operation, programming or applications of Rohde & Schwarz equipment.

Up-to-date information and upgrades

To keep your Rohde & Schwarz equipment always up-to-date, please subscribe to our electronic newsletter at

<http://www.rohde-schwarz.com/www/response.nsf/newsletterpreselection>

or request the desired information and upgrades via email from your Customer Support Center (addresses see below).

Feedback

We want to know if we are meeting your support needs. If you have any comments please email us and let us know CustomerSupport.Feedback@rohde-schwarz.com.

USA & Canada

Monday to Friday (except US public holidays)

8:00 AM – 8:00 PM Eastern Standard Time (EST)

Tel. from USA 888-test-rsa (888-837-8772) (opt 2)

From outside USA +1 410 910 7800 (opt 2)

Fax +1 410 910 7801

E-mail Customer.Support@rsa.rohde-schwarz.com

East Asia

Monday to Friday (except Singaporean public holidays)

8:30 AM – 6:00 PM Singapore Time (SGT)

Tel. +65 6 513 0488

Fax +65 6 846 1090

E-mail Customersupport.asia@rohde-schwarz.com

Rest of the World

Monday to Friday (except German public holidays)

08:00 – 17:00 Central European Time (CET)

Tel. from Europe +49 (0) 180 512 42 42

From outside Europe +49 89 4129 13776

Fax +49 (0) 89 41 29 637 78

E-mail CustomerSupport@rohde-schwarz.com



Adressen/Addresses

FIRMENSITZ/HEADQUARTERS

(Tel) Phone
(Fax) Fax
E-mail

Rohde & Schwarz GmbH & Co. KG
Mühlendorfstraße 15 · D-81671 München
Postfach 80 14 69 · D-81614 München

(Tel) +49 (89) 41 29-0
(Fax) +49 89 4129-121 64
info@rohde-schwarz.com

WERKE/PLANTS

Rohde & Schwarz Messgerätebau GmbH
Riedbachstraße 58 · D-87700 Memmingen
Postfach 1652 · D-87686 Memmingen

(Tel) +49 (8331) 108-0
(Fax) +49 (8331) 108-11 24
info.rsdbm@rohde-schwarz.com

Rohde & Schwarz GmbH & Co. KG
Werk Teisnach
Kaikenrieder Straße 27 · D-94244 Teisnach
Postfach 1149 · D-94240 Teisnach

(Tel) +49 (9923) 857-0
(Fax) +49 (9923) 857-11 74
info.rsdt@rohde-schwarz.com

Rohde & Schwarz GmbH & Co. KG
Dienstleistungszentrum Köln
Graf-Zeppelin-Straße 18 · D-51147 Köln
Postfach 98 02 60 · D-51130 Köln

(Tel) +49 (2203) 49-0
(Fax) +49 (2203) 49 51-229
info.rsd@rohde-schwarz.com
schwarz.com-service.rsd@rohde-schwarz.com

TOCHTERUNTERNEHMEN/SUBSIDIARIES

Rohde & Schwarz Vertriebs-GmbH
Mühlendorfstraße 15 · D-81671 München
Postfach 80 14 69 · D-81614 München

(Tel) +49 (89) 41 29-137 74
(Fax) +49 (89) 41 29-137 77
customersupport@rohde-schwarz.com

Rohde & Schwarz International GmbH
Mühlendorfstraße 15 · D-81671 München
Postfach 80 14 60 · D-81614 München

(Tel) +49 (89) 41 29-129 84
(Fax) +49 (89) 41 29-120 50
info.rusis@rohde-schwarz.com

Rohde & Schwarz Engineering and Sales GmbH
Mühlendorfstraße 15 · D-81671 München
Postfach 80 14 29 · D-81614 München

(Tel) +49 (89) 41 29-137 11
(Fax) +49 (89) 41 29-137 23
info.rse@rohde-schwarz.com

R&S BICK Mobilfunk GmbH
Fritz-Hahne-Str. 7 · D-31848 Bad Münder
Postfach 2062 · D-31844 Bad Münder

(Tel) +49 (5042) 998-0
(Fax) +49 (5042) 998-105
info.rsbeck@rohde-schwarz.com

Rohde & Schwarz FTK GmbH
Wendenschlossstraße 168, Haus 28
D-12557 Berlin

(Tel) +49 (30) 658 91-122
(Fax) +49 (30) 655 50-221
info.ftk@rohde-schwarz.com

Rohde & Schwarz SIT GmbH
Agastraße 3
D-12489 Berlin

(Tel) +49 (30) 658 84-0
(Fax) +49 (30) 658 84-183
info.sit@rohde-schwarz.com

R&S Systems GmbH
Graf-Zeppelin-Straße 18 · D-51147 Köln
Postfach 98 02 60 · D-51130 Köln

(Tel) +49 (2203) 49-5 23 25
(Fax) +49 (2203) 49-5 23 36
info.rssys@rohde-schwarz.com

ADRESSEN WELTWEIT/ADDRESSES WORLDWIDE

Albania siehe/see Austria

Algeria Rohde & Schwarz
Bureau d'Alger
5B Place de Laperrine
16035 Hydra-Alger

(Tel) +213 (21) 48 20 18
(Fax) +213 (21) 69 46 08

Antilles (Neth.) siehe / see Mexico

Argentina Precision Electronica S.R.L.
Av. Pde Julio A. Roca 710 - 6° Piso
1067 Buenos Aires

(Tel) +541 (14) 331 10 67
(Fax) +541 (14) 334 51 11
alberto.lombardi@prec-elec.com.ar

Australia Rohde & Schwarz (Australia) Pty. Ltd.
Sales Support
Unit 6
2-8 South Street
Rydalmere, N.S.W. 2116

(Tel) +61 (2) 88 45 41 00
(Fax) +61 (2) 96 38 39 88
sales@rsa.us.rohde-schwarz.com

Austria Rohde & Schwarz-Österreich Ges.m.b.H.
Am Europlatz 3
Gebäude B
1120 Wien

(Tel) +43 (1) 602 61 41-0
(Fax) +43 (1) 602 61 41-14
rs-austria@rsoe.rohde-schwarz.com

Azerbaijan Rohde & Schwarz Azerbaijan
Liaison Office Baku
ISR Plaza, 5th floor
340 Nizami Str.
370000 Baku

(Tel) +994 (12) 93 31 38
(Fax) +994 (12) 93 03 14
rs-azerbaijan@rsd.rohde-schwarz.com

Bangladesh BIL Consortium Ltd.
Corporate Office
House-33, Road-4, Block-F
Banani, Dhaka-1213

(Tel) +880 (2) 881 06 53
(Fax) +880 (2) 882 82 91

Barbados siehe / see Mexico

Belarus siehe/see Ukraine

Belgium Rohde & Schwarz Belgium N.V.
Excelsiorlaan 31 Bus 1
1930 Zaventem

(Tel) +32 (2) 721 50 02
(Fax) +32 (2) 725 09 36
info@rsb.rohde-schwarz.com

Belize siehe / see Mexico

Bermuda siehe/see Mexico

Bosnia-Herzegovina siehe/see Slovenia

Brazil Rohde & Schwarz Do Brasil Ltda.
Av. Alfredo Egidio de Souza Aranha (Bd. Aranha)
1° andar - Santo Amaro
04726-170 Sao Paulo - SP

(Tel) +55 (11) 56 44 86 11
(Fax) +55 (11) 56 44 86 25 (sales)
(Fax) +55 (11) 56 44 86 36
sales-brazil@rsdb.rohde-schwarz.com

Brunei George Keen Lee Equipment Pte Ltd.
#11-01 BP Tower
396 Alexandra Road
Singapore 119954

(Tel) +656 276 06 26
(Fax) +656 276 06 29
gkleqpt@singnet.com.sg

Bulgaria Rohde & Schwarz
Representation Office Bulgaria
39, Fridtjof Nansen Blvd.
1000 Sofia

(Tel) +359 (2) 96 343 34
(Fax) +359 (2) 963 21 97
rs-bulgaria@rsbg.rohde-schwarz

Canada Rohde & Schwarz Canada Inc.
555 March Rd.
Kanata, Ontario K2K 2M5

(Tel) +1 (613) 592 80 00
(Fax) +1 (613) 592 80 09
sales@rscanada.ca

Chile Dymeq Ltda.
Av. Larrain 6666
Santiago

(Tel) +56 (2) 339 20 00
(Fax) +56 (2) 339 20 10
dymeq@dymeq.com

China Rohde & Schwarz China Ltd.
Representative Office Beijing
6F, Parkview Center
2 Jianguai Road
Chao Yang District
Beijing 100016

(Tel) +86 (10) 64 31 28 28
(Fax) +86 (10) 64 37 98 88
info.rschina@rsbp.rohde-schwarz.com

Rohde & Schwarz China Ltd.
Representative Office Shanghai
Room 807-809, Central Plaza
227 Huangpi North Road
Shanghai 200003

(Tel) +86 (21) 63 75 00 18
(Fax) +86 (21) 63 75 91 70
May.Zhu@rsbp.rohde-schwarz.com

Rohde & Schwarz China Ltd.
Representative Office Guangzhou
Room 2903, Metro Plaza
183 Tian He North Road
Guangzhou 510075

(Tel) +86 (20) 87 55 47 58
(Fax) +86 (20) 87 55 47 59
Winnie.Lin@rsbp.rohde-schwarz.com

Adressen/Addresses

| | | | | | |
|------------------|--|--|----------------------|---|---|
| India | Rohde & Schwarz India Pvt. Ltd. Mumbai Office B-603, Remi Bizcourt, Shah Industrial Estate, Off Veera Desai Road Andheri West Mumbai - 400 058 | (Tel) +91 (22) 26 30 18 10 (Fax) +91 (22) 26 73 20 81 rsindiam@rsnl.net | Kazakhstan | Rohde & Schwarz Kazakhstan Representative Office Almaty Pl. Respubliki 15 480013 Almaty | (Tel) +7 (32) 72 67 23 54 (Fax) +7 (32) 72 67 23 46 rs-kazakhstan@rsd-rohde-schwarz.com |
| Indonesia | PT Rohde & Schwarz Indonesia Graha Paramita 5th Floor Jln. Denpasar Raya Blok D-2 Jakarta 12940 | (Tel) +62 (21) 252 36 08 (Fax) +62 (21) 252 36 07 sales@rsbj.rohde-schwarz.com-services@rsbj.rohde-schwarz.com | Kenya | Excel Enterprises Ltd Dunga Road P.O.Box 42 788 Nairobi | (Tel) +254 (2) 55 80 88 (Fax) +254 (2) 54 46 79 |
| Iran | Rohde & Schwarz Iran Liaison Office Tehran Groundfloor No. 1, 14th Street Khaled Eslamboli (Vozara) Ave. 15117 Tehran | (Tel) +98 (21) 872 42 96 (Fax) +98 (21) 871 90 12 alfred.korff@rsd.rohde-schwarz.com | Korea | Rohde & Schwarz Korea Ltd. 83-29 Nonhyun-Dong, Kangnam-Ku Seoul 135-010 | (Tel) +82 (2) 34 85 19 00 (Fax) +82 (2) 547 43 00 sales@rskor.rohde-schwarz.com-service@rskor.rohde-schwarz.com |
| Ireland | siehe/see United Kingdom | | Kuwait | Group Five Trading & Contracting Co. Mezzanine Floor Al-Bana Towers Ahmad Al Jaber Street Sharq | (Tel) +965 (244) 91 72/73/74 (Fax) +965 (244) 95 28 jk_agarwal@yahoo.com |
| Israel | Eastronics Ltd. Measurement Products 11 Rozanis St. P.O.Box 39300 Tel Aviv 61392 | (Tel) +972 (3) 645 87 77 (Fax) +972 (3) 645 86 66 david_hasky@easx.co.il | Latvia | Rohde & Schwarz Danmark A/S Latvian Branch Office Merkela iela 21-301 1050 Riga | (Tel) +371 (7) 50 23 55 (Fax) +371 (7) 50 23 60 latvia@rsdk.rohde-schwarz.com |
| | J.M. Moss (Engineering) Ltd. Communications Products 9 Oded Street P.O.Box 967 52109 Ramat Gan | (Tel) +972 (3) 631 20 57 (Fax) +972 (3) 631 40 58 jmoss@zahav.net.il | Lebanon | Rohde & Schwarz Liaison Office Riyadh P.O.Box 361 Riyadh 11411 | (Tel) +966 (1) 465 64 28 Ext. 303 (Fax) +966 (1) 465 64 28 Ext. 229 chris.porzky@rsd.rohde-schwarz.com |
| Italy | Rohde & Schwarz Italia S.p.a. Centro Direzionale Lombardo Via Roma 108 20060 Cassina de Pecchi (MI) | (Tel) +39 (02) 95 70 41 (Fax) +39 (02) 95 30 27 72 rsi.info@rsi.rohde-schwarz.com | | Netcom P.O.Box 55199 Op. Ex-Presidential Palace Horch Tabet Beirut | (Tel) +961 (1) 48 69 99 (Fax) +961 (1) 49 05 11 tohme.sayar@netcomm.tv |
| | Rohde & Schwarz Italia S.p.a. Via Tiburtina 1182 00156 Roma | (Tel) +39 (06) 41 59 81 (Fax) +39 (06) 41 59 82 70 rsi.info@rsi.rohde-schwarz.com | Liechtenstein | siehe/see Switzerland | |
| Jamaica | siehe / see Mexico | | Lithuania | Rohde & Schwarz Danmark A/S Lithuanian Branch Office Lukiskiu 5-228 2600 Vilnius | (Tel) +370 (5) 239 50 10 (Fax) +370 (5) 239 50 11 lithuania@rsdk.rohde-schwarz.com |
| Japan | Rohde & Schwarz Japan K.K. Tokyo Office 711 Bldg., Room 501 (5th floor) 7-11-18 Nishi-Shinjuku Shinjuku-ku Tokyo 160-0023 | (Tel) +81 (3) 59 25 12 88 (Fax) +81 (3) 59 25 12 90 scj.support@rsjp.rohde-schwarz.com | Luxembourg | siehe/see Belgium | |
| | Rohde & Schwarz Japan K.K. Shin-Yokohama Office KM Daiichi Bldg., 8F 2-13-13 Kouhoku-ku Yokohama-shi Kanagawa 222-0033 | (Tel) +81 (4) 54 77 35 70 | Macedonia | NETRA Sarski odred 7 1000 Skopje | (Tel) +389 (2) 329 82 30 (Fax) +389 (2) 317 74 88 netra@netra.com.sk |
| | Rohde & Schwarz Japan K.K. Osaka Office TEK Dai 2 Bldg., 8F 1-13-20 Esaka-shi Suita-shi Osaka-fu 564-0063 | (Tel) +81 (6) 63 10 96 51 | Malaysia | Rohde & Schwarz Malaysia Sdn Bhd Suite 10.04, Level 10, Wisma E&C No. 2 Lorong Dungun Kiri Damansara Heights 50490 Kuala-Lumpur | (Tel) +60 (3) 20 94 00 33 (Fax) +60 (3) 20 94 24 33 sales.malaysia@rohde-schwarz.com |
| Jordan | Jordan Crown Engineering & Trading Co. Jabal Amman, Second Circle Youssef Ezzideen Street P.O.Box 830414 Amman, 11183 | (Tel) +962 (6) 462 17 29 (Fax) +962 (6) 465 96 72 jocrown@go.com.jo | Malta | Tektraco International Technology Ltd. 121, B'Kara Road San Gwann SGN 08 | (Tel) +356 (21) 37 43 00 or 37 80 88 (Fax) +356 (21) 37 66 67 sales@tektraco.com |
| | | | Mexico | Rohde & Schwarz de Mexico S. de R.L. de C.V. German Centre Oficina 4-2-2 Av. Santa Fé 170 Col. Lomas de Santa Fé 01210 Mexico D.F. | (Tel) +52 (55) 85 03 99 13 (Fax) +52 (55) 85 03 99 16 latinoamerica@rsd-rohde-schwarz.com |
| | | | Moldava | siehe/see Austria | |
| | | | Nepal | ICTC Pvt. Ltd. Hattisar, Post Box No. 660 Kathmandu | (Tel) +977 (1) 443 48 95 (Fax) +977 (1) 443 49 37 ictc@mos.com.np |

Adressen/Addresses

| | | | | | |
|---------------------------|---|--|--------------------------|---|--|
| Netherlands | Rohde & Schwarz Nederland B.V. Perkinsbaan 1 3439 ND Nieuwegein | (Tel) +31 (30) 600 17 00 (Fax) +31 (30) 600 17 99 info@rsn.rohde-schwarz.com | Saudi Arabia | Gentec Haji Abdullah Alireza & Co. Ltd. P.O.Box 43054 Riyadh | (Tel) +966 (1) 293 20 35 (Fax) +966 (1) 466 16 57 akanbar@gentec.com.sa |
| New Zealand | Nichecom 1 Lincoln Ave. Tawa, Wellington | (Tel) +64 (4) 232 32 33 (Fax) +64 (4) 232 32 30 rob@nichecom.co.nz | Serbia-Montenegro | Rohde & Schwarz Representative Office Belgrade Tose Jovanovica 7 11030 Beograd | (Tel) +381 (11) 305 50 25 (Fax) +381 (11) 305 50 24 rs-scg@rscs.rohde-schwarz.com |
| Nicaragua | siehe/see Mexico | | Singapore | Rohde & Schwarz Regional Headquarters Singapore Pte. Ltd. 1 Kaki Bukit View #05-01/02 Techview Singapore 415 941 | (Tel) +65 68 46 18 72 (Fax) +65 68 46 12 52 |
| Nigeria | Ferrostaal Abuja Plot 3323, Barada Close P.O.Box 8513, Wuse Off Amazon Street Maitama, Abuja | (Tel) +234 (9) 413 52 51 (Fax) +234 (9) 413 52 50 fsabuja@rosecom.net | | | |
| Norway | Rohde & Schwarz Norge AS Enebakkeveien 302 B 1188 Oslo | (Tel) +47 (23) 38 66 00 (Fax) +47 (23) 38 66 01 firmapost@rsnor.rohde-schwarz.com | | Rohde & Schwarz Systems & Communications Asia Pte Ltd Service 1 Kaki Bukit View #04-01/07 Techview Singapore 415 941 | (Tel) +65 68 46 37 10 (Fax) +65 68 46 00 29 info@rssg.rohde-schwarz.com |
| Oman | Mustafa Sultan Science & Industry Co.LLC. Test & Measurement Products Way No. 3503 Building No. 241 Postal Code 112 Al Khuwair, Muscat | (Tel) +968 63 60 00 (Fax) +968 60 70 66 m-aziz@mustafasultan.com | Slovak Republic | Specialne systémy a software, a.s. Svrčia ul. 3 841 04 Bratislava 4 | (Tel) +421 (2) 65 42 24 88 (Fax) +421 (2) 65 42 07 68 3s@special.sk |
| Pakistan | Siemens Pakistan 23, West Jinnah Avenue Islamabad | (Tel) +92 (51) 227 22 00 (Fax) +92 (51) 227 54 98 reza.bokhary@siemens.com.pk | Slovenia | Rohde & Schwarz Representative Office Ljubljana Tbilisjska 89 1000 Ljubljana | (Tel) +386 (1) 423 46 51 (Fax) +386 (1) 423 46 11 rs-slovenia@rssi.rohde-schwarz.com |
| Panama | siehe/see Mexico | | South Africa | Protea Data Systems (Pty.) Ltd. Communications and Measurement Division Private Bag X19 Bramley 2018 | (Tel) +27 (11) 719 57 00 (Fax) +27 (11) 786 58 91 unicm@protea.co.za |
| Papua New Guinea | siehe/see Australia | | | | |
| Paraguay | siehe/see Argentina | | | | |
| Philippines | Rohde & Schwarz (Philippines) Inc. Unit 2301, PBCOM Tower 6795, Ayala Ave. cor. Herrera St. Makati City | (Tel) +63 (2) 753 14 44 (Fax) +63 (2) 753 14 56 | | Protea Data Systems (Pty.) Ltd. Cape Town Branch Unit G9, Centurion Business Park Bosmandam Road Milnerton Cape Town, 7441 | (Tel) +27 (21) 555 36 32 (Fax) +27 (21) 555 42 67 unicm@protea.co.za |
| Poland | Rohde & Schwarz SP.z o.o. Przedstawicielstwo w Polsce ul. Stawki 2, Pietro 28 00-193 Warszawa | (Tel) +48 (22) 860 64 94 (Fax) +48 (22) 860 64 99 rs-poland@rspl.rohde-schwarz.com | Spain | Rohde & Schwarz Espana S.A. Salcedo, 11 28034 Madrid | (Tel) +34 (91) 334 10 70 (Fax) +34 (91) 729 05 06 rses@rses.rohde-schwarz.com |
| Portugal | Rohde & Schwarz Portugal, Lda. Alameda Antonio Sergio 7-R/C - Sala A 2795-023 Linda-a-Velha | (Tel) +351 (21) 415 57 00 (Fax) +351 (21) 415 57 10 info@rspt.rohde-schwarz.com | | Rohde & Schwarz Espana S.A. Av. Príncipe d'Astúries, 66 08012 Barcelona | (Tel) +34 (93) 415 15 68 (Fax) +34 (93) 237 49 95 bcn@rses.rohde-schwarz.com |
| Republic Dominican | siehe/see Mexico | | Sri Lanka | Dynatel Communications (PTE) Ltd. 451/A Kandy Road Kelaniya | (Tel) +94 (112) 90 80 01 (Fax) +94 (112) 91 04 69 69 dynatel@dyanet.lk |
| Romania | Rohde & Schwarz Representation Office Bucharest 89 Eroii Sanitari Blvd., sector 5 050472 Bucuresti | (Tel) +40 (21) 411 20 13 (Fax) +40 (21) 410 68 46 rs-romania@rsro.rohde-schwarz.com | Sudan | SolarMan Co. Ltd. P.O.Box 11 545 North of Fraouq Cementry 6/7/9 Bldg. 16 Karthoum | (Tel) +249 (183) 47 31 08 (Fax) +249 (183) 47 31 38 solarman29@hotmail.com |
| Russian Federation | Rohde & Schwarz International GmbH 119180, Yakimanskaya nab., 2 Moscow | (Tel) +7 (095) 745 88 50 to 53 (Fax) +7 (095) 745 88 54 rs-russia@rsru.rohde-schwarz.com | Sweden | Rohde & Schwarz Sverige AB Flygfältsgatan 15 128 30 Skarpnäck | (Tel) +46 (8) 605 19 00 (Fax) +46 (8) 605 19 80 info@rss.rohde-schwarz.com |
| Saudi Arabia | Rohde & Schwarz International GmbH - Liaison Office Riyadh c/o Haji Abdullah Alireza Co. Ltd. P.O.Box 361 Riyadh 11411 | (Tel) +966 (1) 293 2035 (Fax) +966 (1) 466 1657 chris.porzky@rsd.rohde-schwarz.com | Switzerland | Roschi Rohde & Schwarz AG Mühlestr. 7 3063 Ittigen | (Tel) +41 (31) 922 15 22 (Fax) +41 (31) 921 81 01 support@roschi.rohde-schwarz.com |
| | | | Syria | Electro Scientific Office Baghdad Street Dawara Clinical Lab. Bldg P.O.Box 8162 Damascus | (Tel) +963 (11) 231 59 74 (Fax) +963 (11) 231 88 75 memo@hamshointl.com |

Adressen/Addresses

| | | | | | |
|------------------------------|---|--|-----------------------|--|---|
| Taiwan | Rohde & Schwarz Taiwan (Pvt.) Ltd. Floor 14, No. 13, Sec. 2, Pei-Tou Road Taipei 112 | (Tel) +886 (2) 28 93 10 88 (Fax) +886 (2) 28 91 72 60 celine.tu@rstw.rohde-schwarz.com | United Kingdom | Rohde & Schwarz UK Ltd. 3000 Manchester Business Park Aviator Way Manchester M22 5TG | (Tel) +44 (870) 735 16 42 (Fax) +44 (1252) 81 14 77 sales@rsuk.rohde-schwarz.com |
| Tanzania | SSTL Group P.O. Box 7512 Dunga Street Plot 343/345 Dar Es Salaam | (Tel) +255 (22) 276 00 37 (Fax) +255 (22) 276 02 93 sstl@ud.co.tz | Uruguay | Aeromarine S.A. Cerro Largo 1497 11200 Montevideo | (Tel) +598 (2) 400 39 62 (Fax) +598 (2) 401 85 97 cs@aeromarine.com.uy |
| Thailand | Rohde & Schwarz International Thailand 2nd floor Gems Tower Bangrak, Suriyawong Bangkok 10600 | (Tel) +66 (2) 200 07 29 (Fax) +66 (2) 267 00 79 | USA | Rohde & Schwarz, Inc. Eastern Regional Office (US Headquarters) 8661A Robert Fulton Drive Columbia, MD 21046-2265 | (Tel) +1 (410) 910 78 00 (Fax) +1 (410) 910 78 01 info@rsa.rohde-schwarz.com |
| | Schmidt Electronics (Thailand) Ltd. Messtechnik 202 Le Concorede Tower, 23rd Fl. Ratchadaphisek Rd. Huay kwang Bangkok 10320 | (Tel) +66 (2) 69 41 47 05 (Fax) +66 (2) 69 41 47 06 salestm@schmidtelectronics.com | | Rohde & Schwarz, Inc. Central Regional Office / Systems & EMI Products 8080 Tristar Drive Suite 120 Irving, TX 75063 | (Tel) +1 (469) 713 53 00 (Fax) +1 (469) 713 53 01 info@rsa.rohde-schwarz.com |
| | TPP Operation Co. Ltd. Kommunikationstechnik 41/5 Mooban Tarinee Boromrajchonnee Road Talingchan Bangkok 10170 | (Tel) +66 (2) 880 93 47 (Fax) +66 (2) 880 93 47 | | Rohde & Schwarz, Inc. R&D and Application Support 8905 SW Nimbus Ave Suite 240 Beaverton, OR 97008 | (Tel) +1 (503) 403 47 00 (Fax) +1 (503) 403 47 01 info@rsa.rohde-schwarz.com |
| Trinidad & Tobago | siehe/see Mexico | (Tel) (Fax) | | Rohde & Schwarz, Inc. Western Regional Office 7700 Irvine Center Drive Suite 100 Irvine, CA 92618 | (Tel) +1 (949) 885 70 00 (Fax) +1 (949) 885 70 01 info@rsa.rohde-schwarz.com |
| Tunisia | Teletek 71, Rue Alain Savary Residence Alain Savary (C64) Cit  el Khadra 1003 Tunis | (Tel) +216 (71) 77 33 88 (Fax) +216 (71) 77 05 53 teletek@gnet.tn | | Rohde & Schwarz, Inc. Service & Calibration Center 8661A Robert Fulton Drive Columbia, MD 21046-2265 | (Tel) +1 (410) 910 50 02 (Fax) +1 (410) 910 79 31 service.rsa@rsa.rohde-schwarz.com |
| Turkey | Rohde & Schwarz International GmbH Liaison Office Istanbul Bagdat Cad. 191/3, Arda Apt. B-Blok 81030 Selamicesme-Istanbul | (Tel) +90 (216) 385 19 17 (Fax) +90 (216) 385 19 18 nadir.guerelman@rsd.rohde-schwarz.com | Vietnam | Rohde & Schwarz Representative Office Vietnam Unit 807, 8/F, Schmidt Tower 239 Xuan Thuy Road Cau Giay District Hanoi | (Tel) +84 (4) 834 20 46 |
| Ukraine | Rohde & Schwarz Representative Office Kiev 4, Patris Loumoumba ul. 01042 Kiev | (Tel) +38 (044) 268 60 55 (Fax) +38 (044) 268 83 64 rsbkiev@public.ua.net | West Indies | siehe/see Mexico | |
| United Arab Emirates | Rohde & Schwarz International GmbH Liaison Office Middle East Vertrieb P.O. Box 31156 Abu Dhabi | (Tel) +971 (2) 6335 670 (Fax) +971 (2) 6335 671 Dario Barisoni@rsd.rohde-schwarz.com | | | |
| | Rohde & Schwarz Bick Mobile Communication P.O.Box 17466 JAFZ, PPU ZG-07 Dubai | (Tel) +971 (4) 883 71 35 (Fax) +971 (4) 883 71 36 | | | |
| | Rohde & Schwarz Emirates L.L.C. ESNAAD Premisses at Mussafah, P.O.Box 31156 Abu Dhabi | (Tel) +971 (2) 55 49 411 (Fax) +971 (2) 55 49 433 rsuaeam@emirates.net.ae | | | |
| United Kingdom | Rohde & Schwarz UK Ltd. Ancells Business Park Fleet Hampshire GU51 2UZ | (Tel) +44 (1252) 81 88 88 (sales)+44 (1252) 81 88 18 (service) (Fax) +44 (1252) 81 14 47 sales@rsuk.rohde-schwarz.com | | | |

Contents of Manuals for Spectrum Analyzer FSE

Operating Manual FSE

The operating manual describes the following models and options:

- FSEA20/30 9kHz/20 Hz to 3,5 GHz
- FSEB20/30 9kHz/20 Hz to 7 GHz
- FSEM20/30 9kHz/20 Hz to 26,5 GHz
- FSEK20/30 9kHz/20 Hz to 40 GHz

- Option FSE-B3 TV Demodulator
- Option FSE-B5 FFT Filter
- Option FSE-B8/9/10/11 Tracking Generator
- Option FSE-B13 1 dB Attenuator
- Option FSE-B15 DOS Controller (Id.-Nr: 1073.5696.02/.03)
- Option FSE-B15 Windows NT Controller (Id.-Nr.: 1073.5696.06)
- Option FSE-B16 Ethernet Adapter
- Option FSE-B17 Second IEC/IEEE Bus Interface

Options FSE-B7, Vector Signal Analysis, and FSE-B21, External Mixer Output, are described in separate manuals.

The present operating manual contains comprehensive information about the technical data of the instrument, the setup and putting into operation of the instrument, the operating concept and controls as well as the operation of the FSE via the menus and via remote control. Typical measurement tasks for the FSE are explained using the functions offered by the menus and a selection of program examples.

In addition the operating manual gives information about maintenance of the instrument and about error detection listing the error messages which may be output by the instrument. It is subdivided into 2 volumes containing the data sheet plus 9 chapters:

Volume 1

- The data sheet** informs about guaranteed specifications and characteristics of the instrument.
- Chapter 1** describes the control elements and connectors on the front and rear panel as well as all procedures required for putting the FSE into operation and integration into a test system.
- Chapter 2** gives an introduction to typical measurement tasks of the FSE which are explained step by step.
- Chapter 3** describes the operating principles, the structure of the graphical interface and offers a menu overview.
- Chapter 4** forms a reference for manual control of the FSE and contains a detailed description of all instrument functions and their application.
- Chapter 10** contains an index for the operating manual.

Volume 2

- Chapter 5** describes the basics for programming the FSE, command processing and the status reporting system.
- Chapter 6** lists all the remote-control commands defined for the instrument. At the end of the chapter a alphabetical list of commands and a table of softkeys with command assignment is given.
- Chapter 7** contains program examples for a number of typical applications of the FSE.
- Chapter 8** describes preventive maintenance and the characteristics of the instrument's interfaces.
- Chapter 8** gives a list of error messages that the FSE may generate.
- Chapter 9** contains a list of error messages.
- Chapter 10** contains an index for the operating manual.

Service Manual - Instrument

The service manual - instrument informs on how to check compliance with rated specifications (performance test) and on the self tests.

Service Manual

The service manual is not delivered with the instrument but may be obtained from your R&S service department using the order number 1065.6016.94.

The service manual informs on instrument function, repair, troubleshooting and fault elimination. It contains all information required for the maintenance of FSE by exchanging modules. It contains information about the individual modules of FSE. This comprises the test and adjustment of the modules, fault detection within the modules and the interface description.

Contents - Chapter 1 " Preparing for Operation "

| | |
|--|-------------|
| 1 Preparing for Operation | 1.1 |
| Description of Front and Rear Panel Views | 1.1 |
| Front View..... | 1.1 |
| Rear View | 1.13 |
| Start-Up - Instruments with Windows NT® Controller..... | 1.18 |
| Unpacking the Instrument..... | 1.18 |
| Setting up the Instrument | 1.18 |
| Stand-alone Operation | 1.18 |
| 19" Rack Installation..... | 1.19 |
| EMI Protection Measures | 1.19 |
| Connecting to AC Supply..... | 1.19 |
| AC Power Line Fuses | 1.19 |
| Switching the Instrument on/off | 1.20 |
| Switching on the Instrument | 1.20 |
| Startup Menu and Booting..... | 1.21 |
| Switching off the Instrument..... | 1.21 |
| Energy Saving Mode | 1.21 |
| Battery Backed-up Memory | 1.21 |
| Function Test | 1.22 |
| Controller Function - Windows NT | 1.23 |
| Connecting a Mouse..... | 1.24 |
| Connecting an External Keyboard | 1.25 |
| Connecting an External Monitor | 1.26 |
| Connecting a Printer..... | 1.28 |
| Installation of a Network Printer (with option FSE-B16 only) | 1.34 |
| Connecting a CD-ROM Drive | 1.36 |
| Firmware Update..... | 1.38 |
| Installing Windows NT Software | 1.39 |
| Options | 1.40 |
| Option FSE-B17 – Second IEC/IEEE Interface | 1.40 |
| Installing the software..... | 1.40 |
| Operation..... | 1.42 |
| Option FSE-B5 - FFT Filter..... | 1.43 |
| Option FSE-B16 – Ethernet Adapter | 1.44 |
| Hardware Installation..... | 1.44 |
| Software Installation | 1.45 |
| Operation..... | 1.49 |

| | |
|---|-------------|
| Start-Up - Instruments with MS DOS® Controller or without Controller | 1.56 |
| Unpacking the Instrument..... | 1.56 |
| Instrument Setup | 1.56 |
| 19" Rack Installation..... | 1.56 |
| EMI Protection Measures | 1.57 |
| Connecting to AC Power | 1.57 |
| AC Power Line Fuses | 1.57 |
| Instrument On/Off | 1.57 |
| Battery-Powered Memory | 1.58 |
| Functional Test | 1.58 |
| Connecting a Mouse..... | 1.58 |
| Connecting an External Keyboard | 1.62 |
| Connecting an Output Device | 1.66 |
| Firmware Update..... | 1.70 |
| Options | 1.71 |
| Option FSE-B17 – Second IEC/IEEE Interface | 1.71 |
| Installing the software..... | 1.71 |
| Operation..... | 1.71 |
| Option FSE-B5 - FFT Filter..... | 1.72 |
| Prerequisites | 1.72 |
| Enabling the option..... | 1.72 |
| Option FSE-B16 – Ethernet Adapter | 1.73 |
| Hardware Installation..... | 1.73 |
| BNC (Thin Ethernet, CheaperNet; FSE-B16 Var. 03) | 1.73 |
| AUI (Thick Ethernet; FSE B16 Var. 02) | 1.74 |
| RJ45 (UTP, 10BaseT, Western Connector)..... | 1.74 |
| Software Installation | 1.75 |
| Installation of Network Drivers..... | 1.75 |
| Installation of Network Operating System | 1.78 |
| Operation..... | 1.81 |



1 Preparing for Operation

Chapter 1 describes the controls and connectors of the Spectrum Analyzer FSE by means of the front and rear view. Then follows all the information that is necessary to put the instrument into operation and connect it to the AC supply and to external devices. The description is separated for FSE equipped with Windows NT controller (page 1.18) and FSE without controller or equipped with DOS controller (page 1.58).

A more detailed description of the hardware connectors and interfaces can be found in chapter 8. Chapter 2 provides an introduction into the operation of the FSE by means of typical examples of configuration and measurement; for the description of the concept for manual operation and an overview of menus refer to chapter 3. For a systematic explanation of all menus, functions and parameters and background information refer to the reference part in chapter 4. For remote control of the FSE refer to the general description of the SCPI commands, the instrument model, the status reporting system, and command description in chapter 5 and 6.

Description of Front and Rear Panel Views

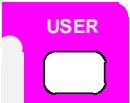
Front View

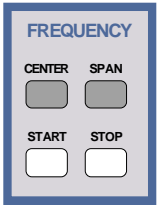
| | | |
|---|--|-------------------|
| 1 | | |
| | Display Screen | see Chap. 3 and 4 |
| 2 | | |
| | Softkeys | see Chap. 3 and 4 |
| 3 USER | | |
|  | Writing Macros | see Chap. 4 |
| 4 MARKER | | |
|  | Select and set marker NORMAL Select and set the marker SEARCH Set and start the peak/min search DELTA Select and set the delta markers MKR ⇒ Set the active marker | see Chap. 4 |
| 5 FREQUENCY | | |
|  | Define frequency axis in the active window CENTER Set center frequency SPAN Set sweep width START Set start frequency STOP Set stop frequency | see Chap. 4 |

6 LINES

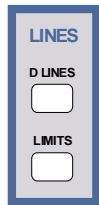

Setup evaluation lines and tolerance limits
 D LINES Setup evaluation lines (display lines)
 LIMITS Definition and recall of tolerance limits

see Chap. 4

7 LEVEL

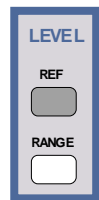

Define reference levels and display range in the active measurement window.
 REF Set reference level (= max. display level)
 RANGE Set range

see Chap. 4

8 DATA ENTRY

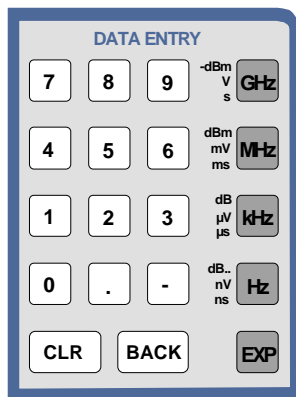

Keypad for data input
 0...9 input numbers
 . input decimal point
 - change sign
 CLR - close input field (for uncompleted or already closed inputs, the original entry is kept)
 - erase the current entry in input field (beginning of an input)
 - close message window (status, error and warning messages)
 BACK erase last character input
 GHz s V -dBm The units keys close the data input and define the multiplication factor for each basic unit.
 MHz ms mV dBm For dimension-less or alphanumeric inputs, the units keys have weight 1.
 kHz μs μV dB.. They behave, in this case, like the ENTER key.
 Hz ns nV dB
 EXP Append an exponent

see Chap. 3

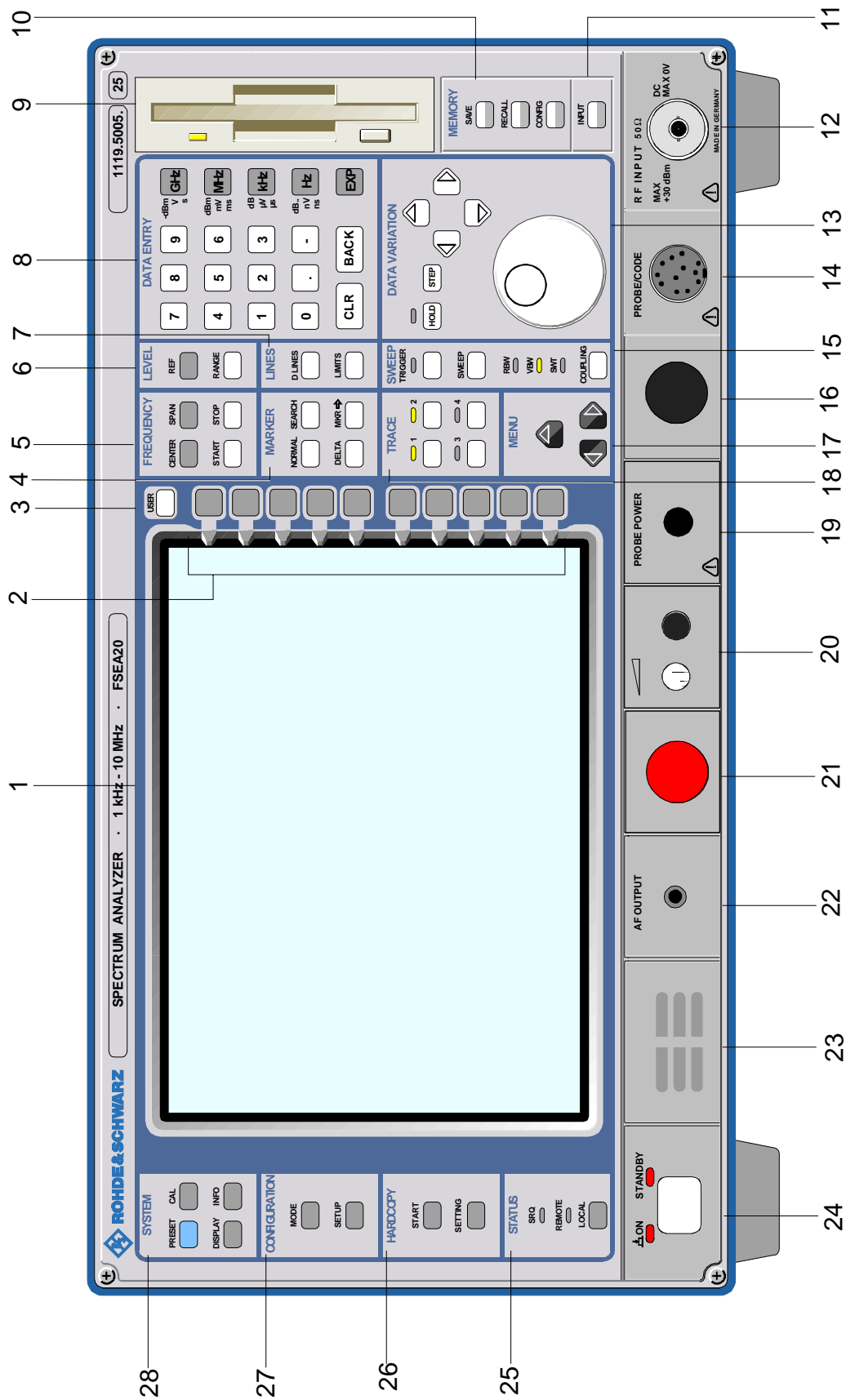

Figure 1-1 Front View

9

3 1/2" diskette drive; 1.44 MByte

10 MEMORY



Memory media and file management

- SAVE Save instrument data
- RECALL Recall instrument data
- CONFIG Configuration of memory media and data

see Chap. 4

11 INPUT

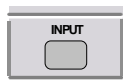

Set impedance and attenuation at the RF input.

see Chap. 4

12 RF INPUT

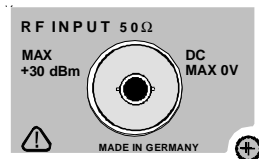

RF-Input



Caution:
The maximum DC voltage is 0 V, the maximum power is 1 W ($\hat{=}$ 30 dBm at \geq 10 dB attenuation)

see Chap. 8

13 DATA VARIATION

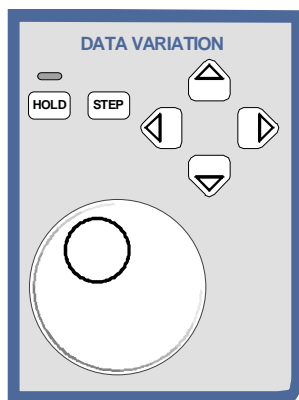

Key group for entering data and for cursor movement

- HOLD** Disable control elements / overall control. The LED indicates the hold condition.
- STEP** Set step size for cursor keys and roll-key.
- Cursor keys** – Move the cursor within the input fields and tables.
– Vary the input value.
– Define the direction of movement for the roll-key.
- Roll-key** – Vary input values.
– Move markers and limits.
– Select letters in the help line editor.
– Move cursor in the tables

see Chap. 3

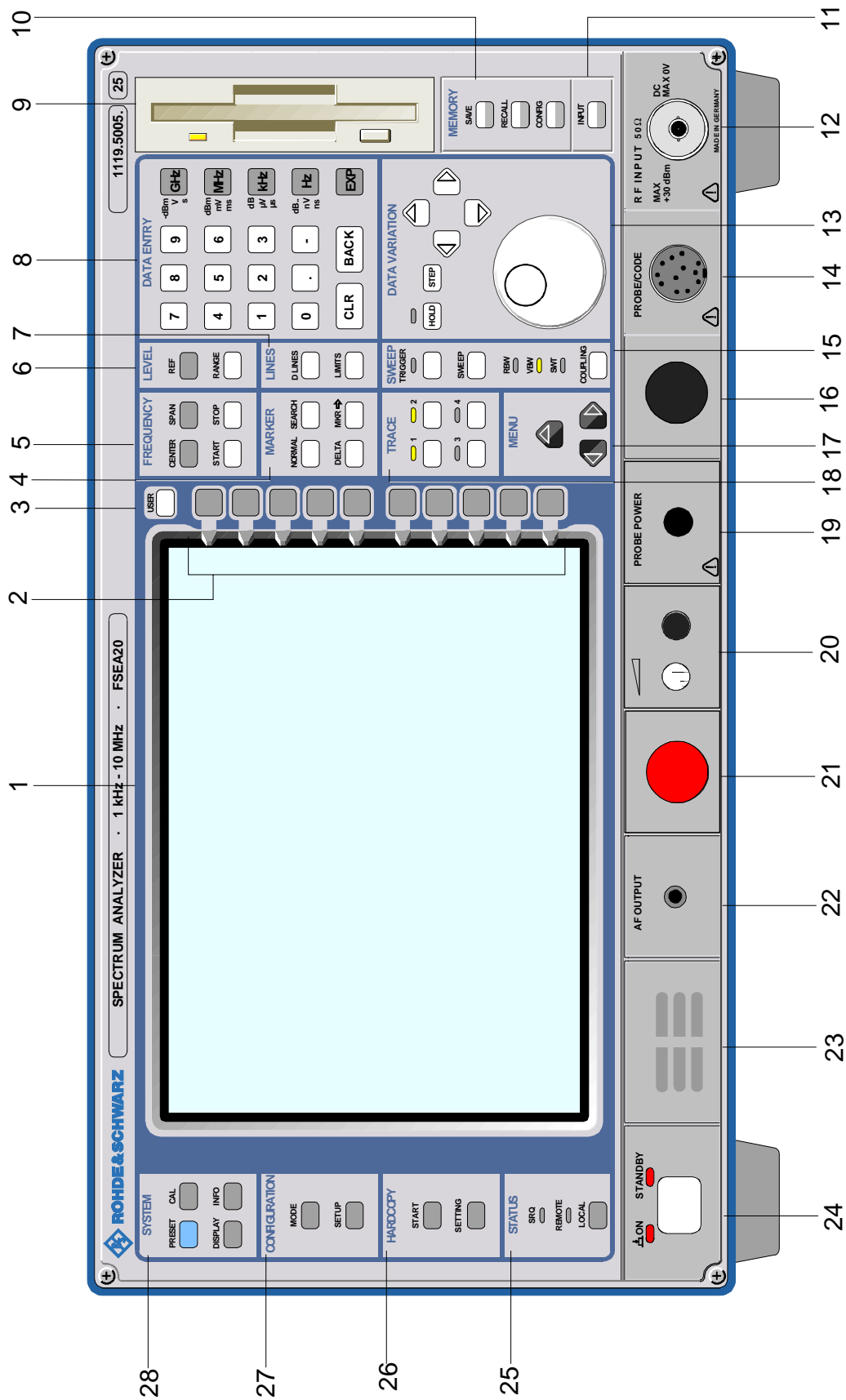
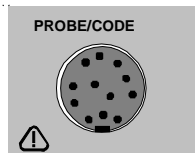

Figure 1-1 Front View

14 PROBE/CODE



Power supply and coded socket for R&S accessories.(12-pin Tuchel)

see Chap. 8

15 SWEEP

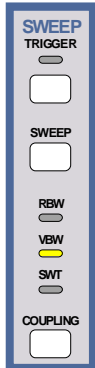

Input sweep parameters

see Chap. 4

TRIGGER Set trigger source. The LED illuminates on valid trigger.

SWEEP Set type of sweep.

COUPLING Set coupled parameters. Resolution BandWidth (RBW), Video BandWidth (VBW) and SWEEP Time (SWT). The LEDs light indicating coupled parameters which are manually cancelled.

16

Reserved for options

17 MENU

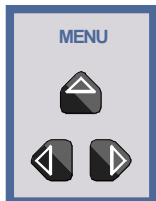

Menu-change keys

see Chap. 3

 Call main menu

 Change to left menu

 Change to right menu

18 TRACE

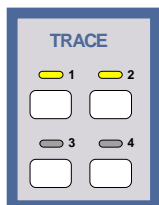

Select and activate measurement traces (Trace 1...4).
The LEDs indicate traces turned on.

see Chap. 4

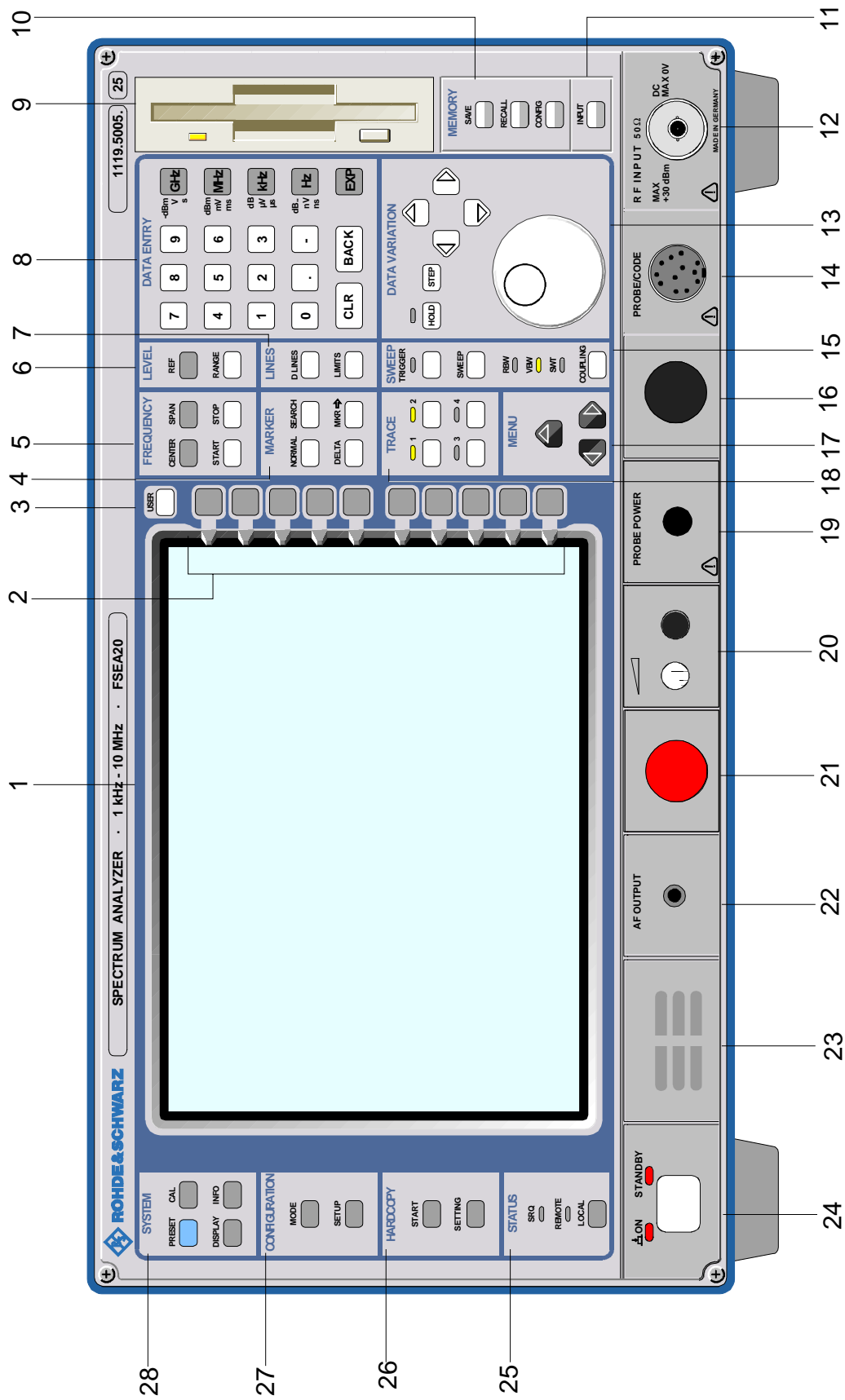
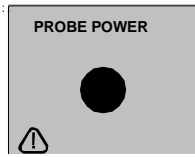

Figure 1-1 Front View

19 PROBE POWER



Power supply connector (+15V / - 12.6V) for measurement accessories (probes)

see Chap. 8

20

Reserved for options

21

Reserved for options

22 AF OUTPUT

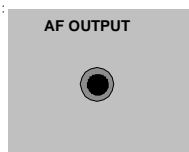

AF output connector (head phones) (miniature phone jack)

see Chap. 8

23



Internal loudspeaker

The loudspeaker is disabled when the phone jack is inserted in the AF output.

see Chap. 8

24

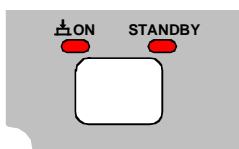

ON/STANDBY



Caution:

In standby mode, the AC line voltage is still present within the instrument.

see Chap. 1

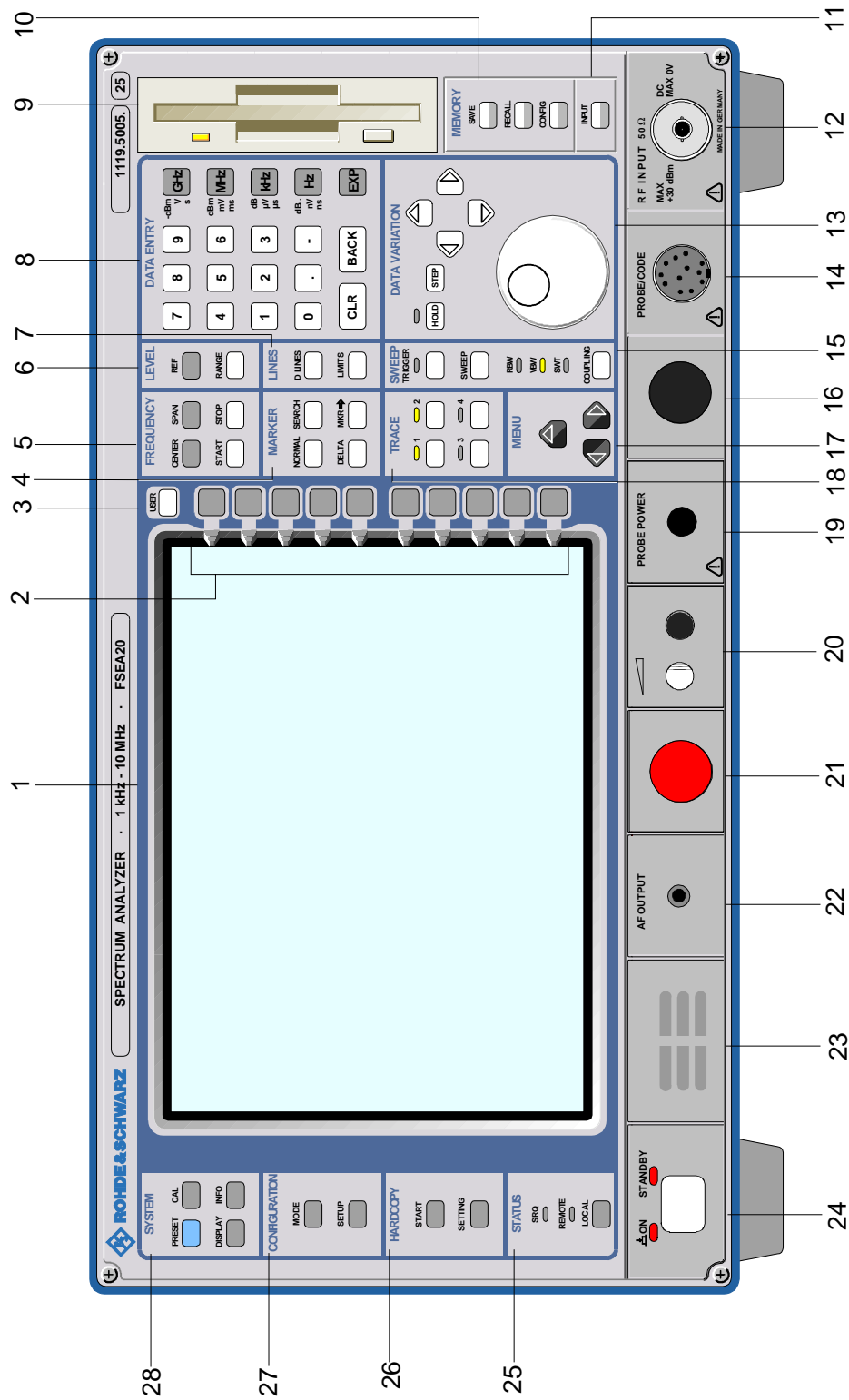
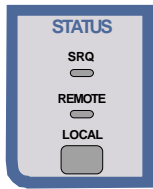

Fig.1-1 Front View

25 STATUS



Indicators for remote control and switch for manual control.

LOCAL Switch from remote to manual control.

The LED SRQ indicates that a service request from the instrument is active on the IEC Bus.

The LED REMOTE indicates that the instrument is under remote control.

see Chap. 4

26 HARDCOPY

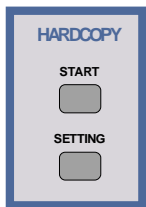

Printer control

START Start a print job with the setup defined in the SETTING menu.

SETTING Configure the diagram, parameter list and measurement protocol outputs on the various output media.

see Chap. 4

27 CONFIGURATION

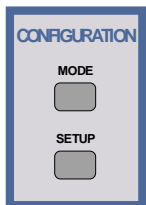

Select operational modes and define default settings

MODE Select mode

SETUP Define configurations

see Chap. 4

28 SYSTEM

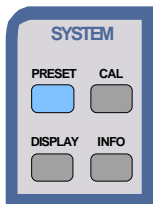

General instrument default settings

PRESET Recall instrument default settings

DISPLAY Configure the display screen format

CAL Calibrate the analyzer

INFO

- Information concerning instrument state and measurement parameters
- Call help functions

see Chap. 4

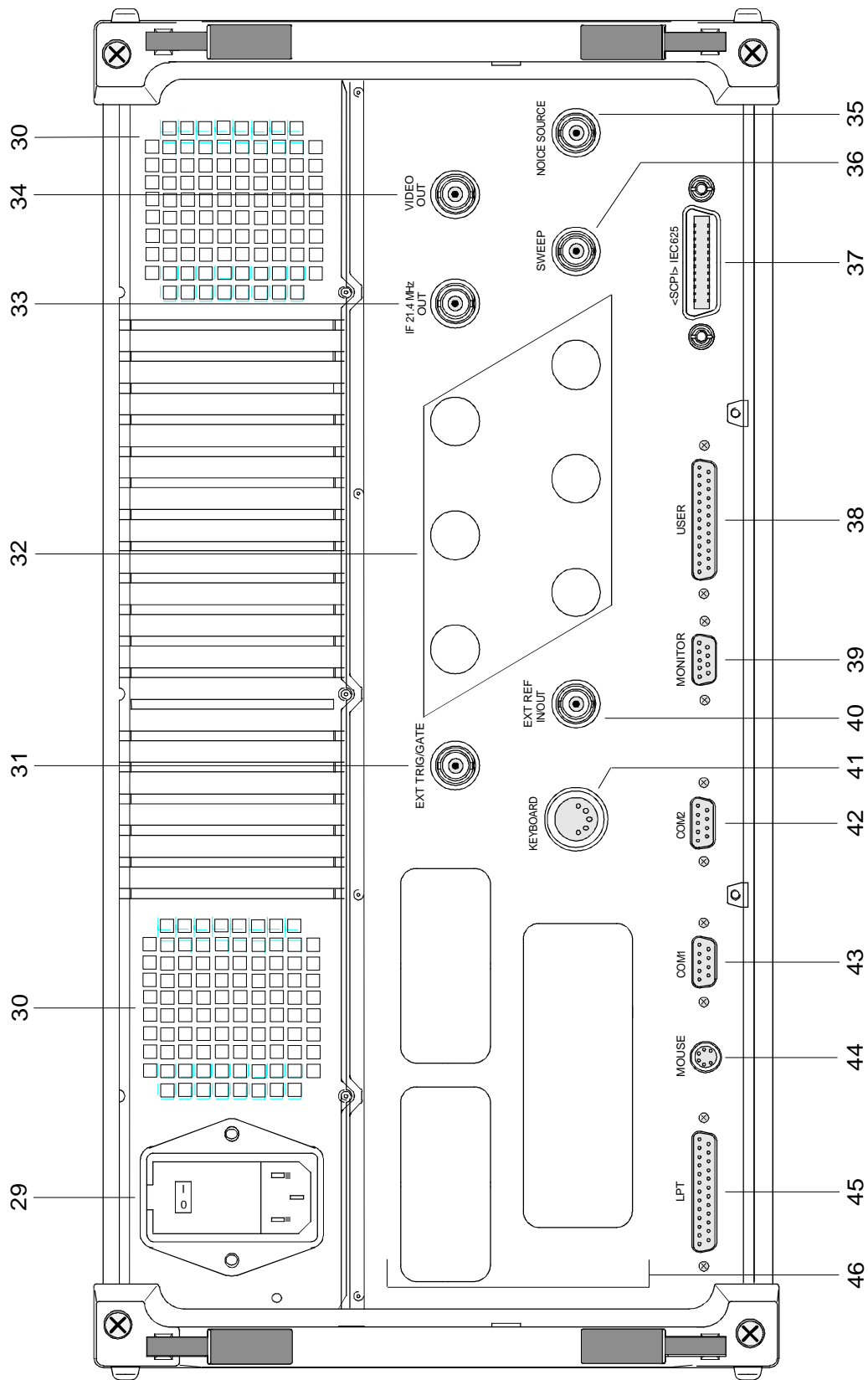
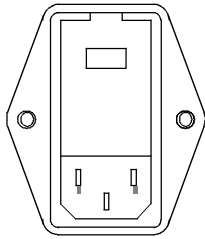

Fig. 1-2 Rear View

Rear View

29



Power switch

Fuse holder

AC power connector

see Chap. 1

30

Power supply fans

31 EXT TRIG/GATE

EXT TRIG/GATE



Input connector for an external trigger or an external gate signal

see Chap. 4 and 8

32

Reserved for options

33 IF 21.4 MHZ OUT

IF 21.4 MHz
OUT



Output connector for 21.4 MHz IF

see Chap. 8

34 VIDEO OUT

VIDEO
OUT



Output connector for video signal

see Chap. 8

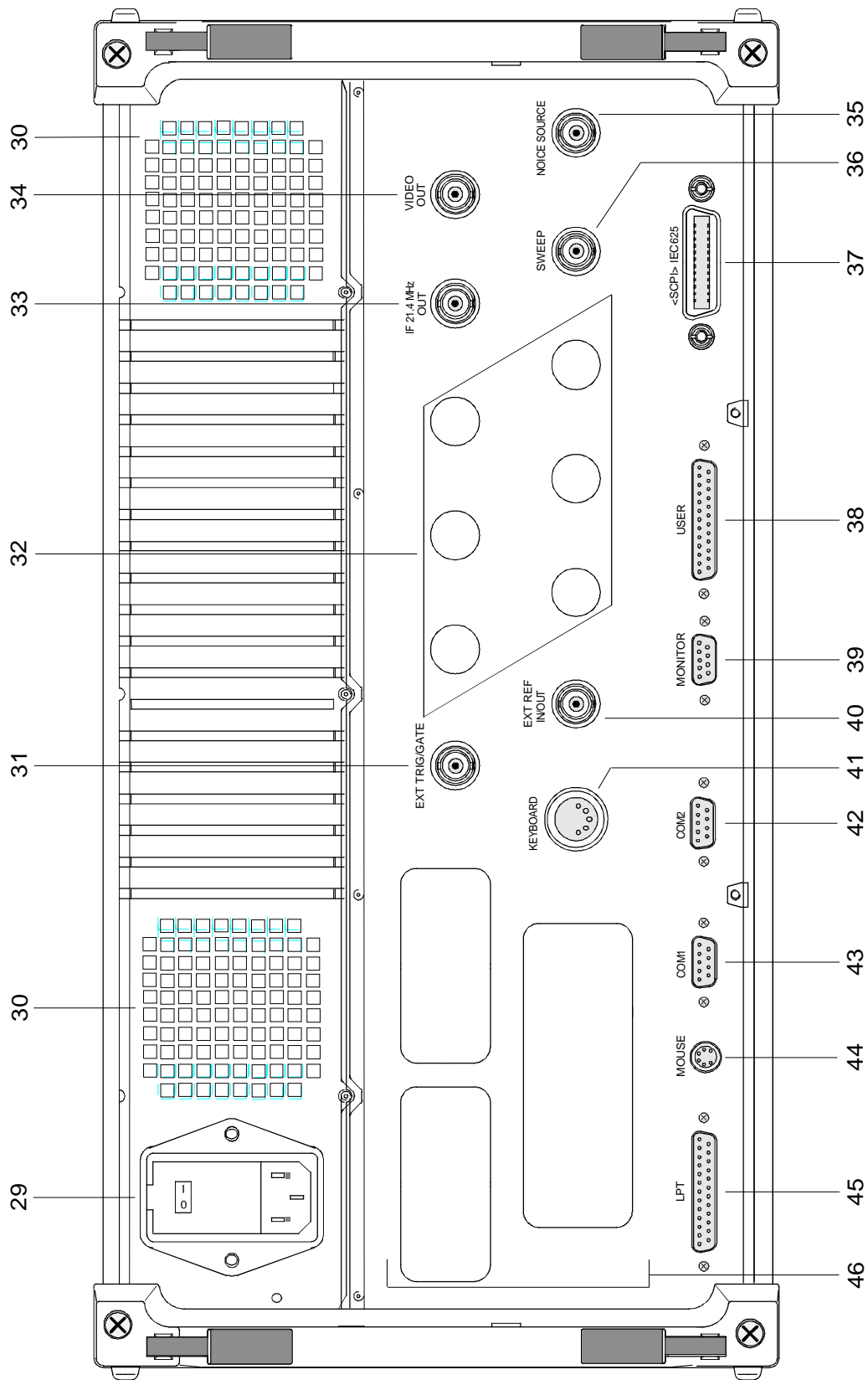

Figure 1-2 Rear View

35 NOISE SOURCE

NOISE SOUR



Output connector for a switchable noise source

see Chap. 8

36 SWEEP

SWEEP



Output connector

During a sweep, a sawtooth voltage is output which is proportional to frequency.

see Chap. 8

37 <SCPI> IEC625

<SCPI> IEC625



IEC/IEEE-bus-connector

see Chap. 8

38 USER

USER

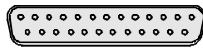

User interface connector with configurable inputs and outputs (USER-PORT A and USER-PORT B)

see Chap. 8

39 MONITOR

MONITOR



Connector for an external VGA monitor

see Chap. 8

40 EXT REF IN/OUTEXT REF
IN/OUT

Input connector for an external reference (1 to 16 MHz), switchable to 10 MHz output

see Chap. 4 and 8

41 KEYBOARD

KEYBOARD

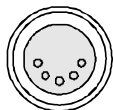

Connector for an external keyboard (5-pin DIN socket)

see Chap. 1 and 8

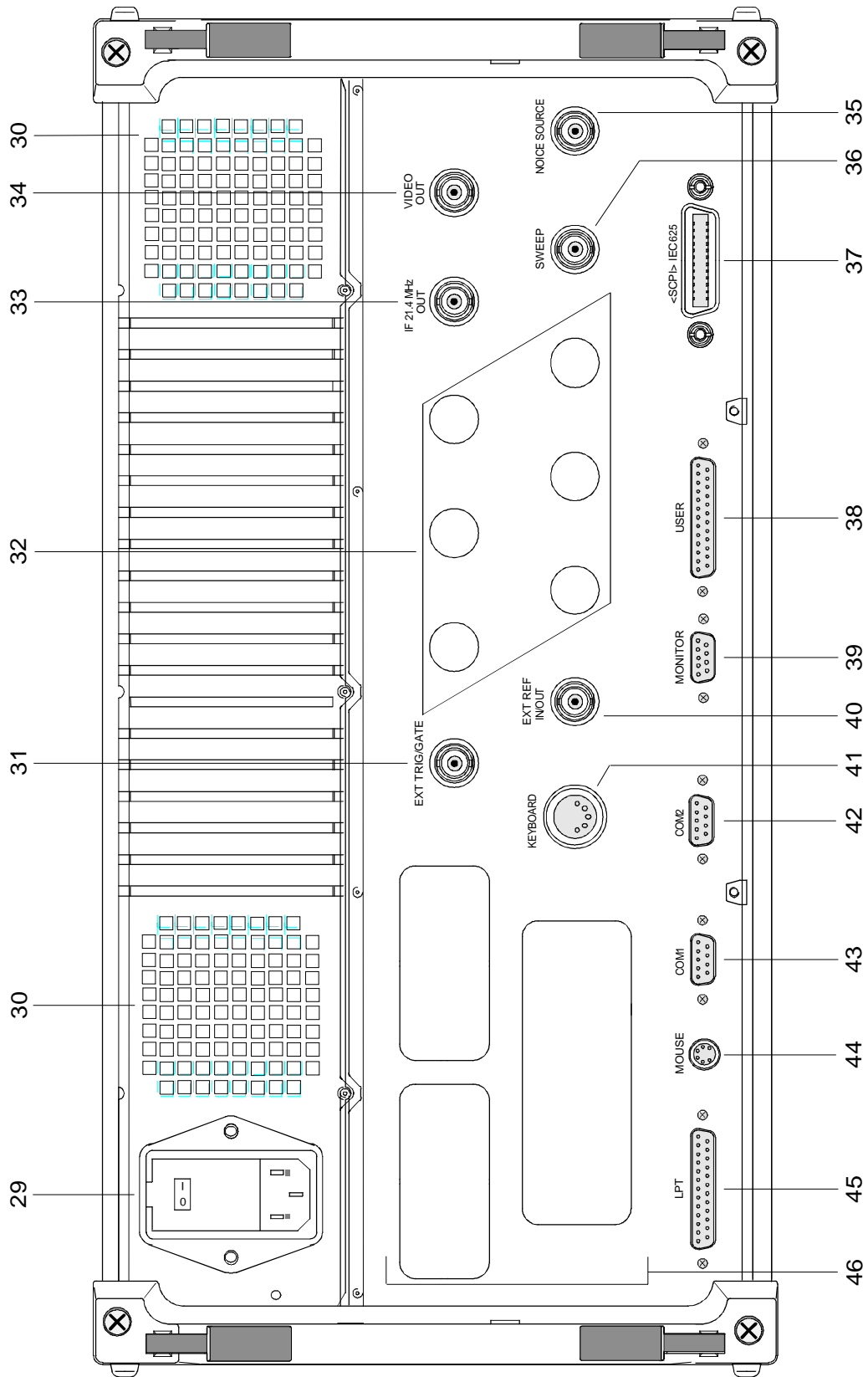

Figure 1-2 Rear View

42 COM2

Connector for serial interface 2
(9-pin socket; COM2)

|| see Chap. 1 and 8

43 COM1

Connector for serial interface 1
(9-pin socket; COM1)

|| see Chap. 1 and 8

44 MOUSE

Connector for a PS/2 mouse

|| see Chap. 1 and 8

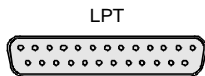
45 LPT

Parallel interface connector
(printer connector, Centronics compatible)

|| see Chap. 1 and 8

46

Inputs / Outputs for options
(cover plates for digital interface expansion)

||

Start-Up - Instruments with Windows NT[®] Controller

The following section describes how to put the instrument into service and how to connect external devices like eg printer and monitor.



Important Note:

Before turning the instrument on, check the following:

- *instrument covers are in place and screwed down,*
- *fan openings are free from obstructions,*
- *signal levels at the input connectors are all within specified limits,*
- *signal outputs are connected correctly and not overloaded.*

The instrument may be damaged if the above conditions are not observed.

Unpacking the Instrument

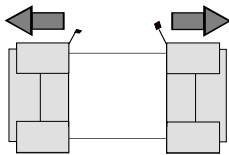

remove protective caps

- Take the instrument out of its transport container and check whether the items listed in the packing list and in the lists of accessories are all there.
- Remove the two protective covers from the front and rear of the FSE and carefully check the instrument for damage.
- Should the instrument be damaged, immediately notify the carrier which shipped the instrument to you and keep the container and packing material.
- For further transport or shipment of the FSE the original packing should also be used. It is recommended to keep at least the two protective covers for the front and rear to prevent damage to the controls and connectors.

Setting up the Instrument

Stand-alone Operation

The instrument is designed for use under general laboratory conditions. The ambient conditions must be as follows:

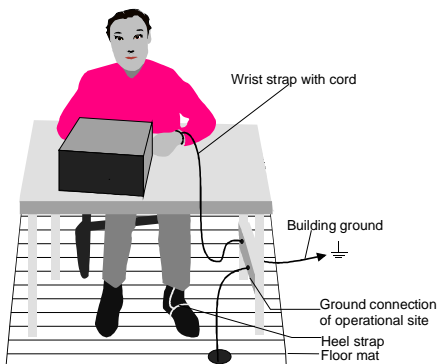

- The ambient temperature must be in the range recommended in the data sheet.
- All fan openings must be unobstructed and the air flow at the rear panel and at the side-panel perforations must not be obstructed. The distance from the wall should be at least 10 cm.
- The FSE should be placed on a level surface.
- In order to avoid damage of electronic components of the instrument or of the device under test due to electrostatic discharge on manual touch, protection of the operational site against electrostatic discharge is recommended.

For applications in the laboratory or on a work bench, it is recommended that the support feet on the bottom of the instrument be extended. For the LCD display, this provides the optimum viewing angle which typically ranges from perpendicular to the display front to approximately 30° below.

19" Rack Installation

**Important Note:**

When the instrument is rack-mounted, ensure that the air flow through the side-panel holes and the air outlet in the rear panel are not obstructed.

The instrument may be mounted in a 19" rack by using the rack adapter kit ZZA-95 (order number: see data sheet). The installation instructions are included in the adapter kit.

EMI Protection Measures

In order to prevent electromagnetic interference (EMI), the instrument may be operated only when all covers are correctly in place. Only adequately shielded signal and control cables may be used (see recommended accessories).

Connecting to AC Supply

The FSE features automatic AC-line voltage selection (range: see power supply name-plate). The AC power connector is located on the rear panel (see below).

- Connect the instrument to the AC power source using the AC power cable delivered with the instrument.

AC Power Line Fuses

The FSE is protected by two fuses as specified on the power supply name-plate. The fuses are located in a removable fuse holder which is located between the AC power switch and the AC power connector (see below).

Switching the Instrument on/off



Caution:

Do not power down during booting. This may corrupt harddisk files.

Note: On power-up, the drive should contain no disk, since otherwise the instrument will try to boot from the disk.

AC power switch on the rear panel

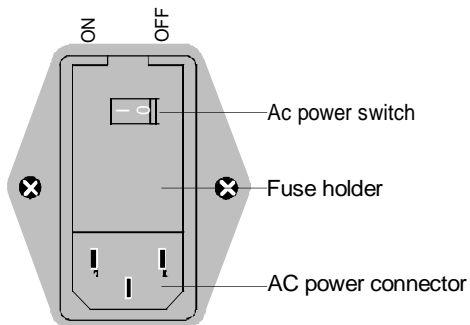

Power switch

After turn-on (position ON), the instrument is in the ready state (STANDBY) or in operation dependent upon the position of the ON/STANDBY switch located on the instrument front panel (see below).

Note: The AC power switch can be left ON all the time.. Switching to OFF is only required when the instrument has to be completely disconnected from the AC power source.

Switching to OFF (position OFF) disconnects the FSE completely from the AC power source.

ON/STANDBY switch on the front panel

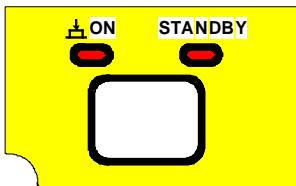

Caution:

In standby mode, the FSE is still live.



Standby

- ON/STANDBY switch is not depressed.

The yellow LED (STANDBY) is on. Only the FSE's internal power is connected to the AC line. The crystal oven is maintained at the normal operating temperature.

Operation

- ON/STANDBY is depressed.

The green LED (ON) is on. The instrument is ready for operation. All modules within the instrument are supplied with power.

Switching on the Instrument

- To switch on the FSE, set the power switch on the rear panel to position I.
- Pressing the ON/STANDBY key on the front panel. The green LED should come on.

Startup Menu and Booting

When the instrument is switched on, a message indicating the installed BIOS version (eg Analyzer BIOS Rev. 1.2) appears on the screen for a few seconds.

Windows NT is booted first and then the instrument firmware. As soon as boot up is over, the instrument will start measuring. The settings used will be the one that was active when the instrument was previously switched off, provided no other device configuration than *FACTORY* had been selected with *AUTO RECALL* in the *MEMORY* menu.

Switching off the Instrument

- Remove the disk, if any, from the drive before switching off.
- Press the ON/STANDBY key on the front panel. The yellow LED should come on.

Only when completely disconnecting the FSE from the AC power source:

- Set the power switch on the rear panel to position 0.

Energy Saving Mode

The FSE offers an energy saving mode for the screen display. The screen goes blank if no entries have been made from the front panel (key, softkey or hotkey and rollkey) for a selectable period of time.

To switch on the energy saving mode:

1. Call the *SYSTEM DISPLAY - CONFIG DISPLAY* submenu to configure the screen display:
 - Press the *DISPLAY* key
 - Press the *CONFIG DISPLAY* softkey
2. Activate the save mode
 - Press the *SCR. SAVER ON* softkey.
The softkey is highlighted, indicating that the energy saving mode is on. At the same time the data entry for the shutdown time opens.
3. Enter the shutdown time
 - Press the *SCR. SAVER TIME* softkey.
 - Enter the shutdown time in minutes and confirm the entry using the *ENTER* key.
The screen will go blank when the shut down time elapses.

Battery Backed-up Memory

The FSE has a battery-powered read/write memory (CMOS-RAM) for backing up instrument settings on power-off. After each power-on, the FSE is reloaded with the operational parameters which were active just prior to the last power-off (STANDBY or AC power OFF) or were set with AUTO RECALL (see Chapter 4 "Saving and Recalling Data Sets").

A lithium battery powers the CMOS-RAM. When the battery goes flat (after approx. 5 years), any data stored in the CMOS-RAM will be lost. If this happens, the factory setup is loaded on power up. As the FSE has to be opened to replace the battery, please contact the representative of our company responsible for you for changing batteries.

Function Test

On power up, the FSE displays the following message on the screen:

```
Analyzer BIOS
Rev.x.y

Copyright
Rohde & Schwarz
Munich

Booting
```

A self-test of the digital hardware is then performed. If the self-test finds no faults, Windows NT is booted up and the instrument starts measuring.

Any errors which occur in self-test are transferred as ASCII text to the printer interface (LPT). Therefore, an error diagnosis can be carried out, even for serious failures.

A check of the data contents of the instrument is performed in system error correction (*CAL*, *CAL TOTAL* key) The individual results of the correction (*PASSED* / *FAILED*) can be displayed in the calibration menu.

With the aid of the built-in self-test functions (*INFO* key, *SELFTTEST* soft key), the functional integrity of the instrument can be verified and/or defective modules can be localized.

Controller Function - Windows NT

**Caution:**

The drivers used in the integrated controller function are specially configured for the instrument. To prevent functions crashing, only the settings described below should be used. Only the update software released by Rohde&Schwarz should be used to update the drivers. Only programs authorized by Rohde&Schwarz for use on the instrument may be run on the instrument.

Do not power down during booting. This may corrupt the harddisk files.

The instrument has an integrated Windows-NT controller. The user can switch between the measurement screen and the controller screen. When an external monitor is connected, the measurement function and the controller function can be displayed simultaneously (see section "Connecting an External Monitor"). The controller function is automatically booted on power-up. Windows NT operation is described in the supplied manual or in the online help of Windows NT.

Login

The user has to login to Windows NT by entering his name and password. As a factory default, the instrument is configured for *Auto Login*, i.e. the login is performed automatically and in the background. The user name used is then "instrument" and the password is also "instrument" (lower case).

To login under another name, call up the logout window in the task bar with START - SHUT DOWN. Mark the item "Close all programs and log on as a different user?" in the window and click YES while holding the SHIFT key down until the login window is displayed to enter the user identification. The password should be entered in the correct syntax including lower-case and upper-case characters.

Administrator identification

Some of the installations (eg CD-ROM drive) described below require the administrator login. This is indicated in the relevant window.

The administrator is an identification which in particular allows system settings which are disabled for the standard user.

The password for the administrator is 894129 for the instrument.

After an installation under the administrator identification, the "Service Pack" of Windows NT has to be re-installed, see section "Installation of Windows NT Software".

On power-up following an installation under the administrator identification, the NT login window is displayed (no autologin). The user name "Administrator" is indicated in the window. This entry is to be replaced by "instrument" and then "instrument" as password entered. An autologin is then possible.

Changeover between measurement screen and controller screen

To call up the controller screen use key combination <ALT><SYSREQ> (US keyboard).

To return to the measurement screen, activate the window "R&S Analyzer Interface" on the controller.

Logout

The instrument can be switched off (standby mode). Logging out of Windows NT is not necessary.

Connecting a Mouse

**Caution:**

The keyboard may only be connected when the instrument is switched off (STANDBY). Otherwise, correct operation of the keyboard cannot be guaranteed.

A mouse can be connected to the PS/2 (MOUSE) connector on the rear panel of the instrument to make it easier to use.

MOUSE



During measurements, softkeys, tables and data input fields may also be controlled by mouse. For computer function, the mouse has the usual functions.

The control functions for the mouse during measurement operation are described in Chapter 3 in the section "Mouse Control of Further Display Elements". This section contains a list in which the screen display elements for mouse control of the corresponding softkeys and push buttons of the instrument are described. Chapter 8 describes the connector interface.

After connection of the mouse and subsequent power-on, the mouse will be automatically recognized. Special settings such as mouse cursor speed etc., can be made in the Windows NT menu START - SETTINGS - CONTROL PANEL - MOUSE.

Connecting an External Keyboard

**Caution:**

The mouse may only be connected when the instrument is switched off (STANDBY). Otherwise, correct operation of the mouse and instrument cannot be guaranteed.

The instrument is fitted with a rear-panel 5-contact DIN connector (KEYBOARD) for the connection of an external PC keyboard.



During measurements, the keyboard makes it easier to enter comments, filenames, etc. For computer function, the keyboard has the usual functions.

Chapter 3, in section "External Keyboard Control", contains a list which describes the assignment of the instrument front-panel key functions to the key codes of the external keyboard as well as special key combinations used for quick operations. Chapter 8 describes the interface for the connector.

After connection of the keyboard and subsequent power-on, the keyboard will be automatically recognized. The default setting is for the US keyboard. Special settings such as repetitional rate etc. can be performed in Windows NT menu START - SETTINGS - CONTROL PANEL - KEYBOARD.

Connecting an External Monitor

**Caution:**

The monitor may only be connected when the instrument is switched off (STANDBY). Otherwise, the monitor may be damaged.

Do not modify the screen driver (display type) as this would cause a malfunction.

Notes:

- When connecting the monitor to the PC MONITOR connector, the display of controller function can be adapted to the external screen (eg higher resolution) in the NT menu START-SETTING - CONTROL PANEL - DISPLAY PROPERTIES.
- CHIPS (setting = both) should not be modified since otherwise switching between the external monitor and the instrument screen is not possible.

The instrument is fitted with a rear-panel connector PC MONITOR or ANALYZER MONITOR for an external monitor.



Chapter 8 describes the connector interface.

With an external monitor it is possible to have an enlarged display of the measurement screen (ANALYZER MONITOR connector) or of the controller screen (PC MONITOR connector). The measuring instrument and the Windows NT controller can be operated in parallel. The mouse and the keyboard are allocated to only one mode.

Display of the measurement screen - Connection to ANALYZER MONITOR connector

Connection

After connecting the external monitor the measurement screen is displayed on both the external monitor and the instrument. Further settings are not necessary.

Operation

The instrument is operated as usual via its softkeys, the mouse and keyboard, etc..

Toggle between measurement screen and controller screen

Key combination <ALT><SYSREQ> is used to call up the controller. After call up, the mouse and keyboard are allocated to the controller function.

By activating the window "R&S Analyzer Interface" the user returns to the measurement screen and the mouse and keyboard are allocated to this screen.

Display of the controller screen - Connection to PC MONITOR connector

Connection

After connecting the monitor external monitor operation should be selected.

Setting is performed in the *SETUP-GENERAL SETUP* menu (key group: *CONFIGURATION*, see in Chapter 4, the section "Presettings and Interface Configuration"):

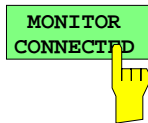
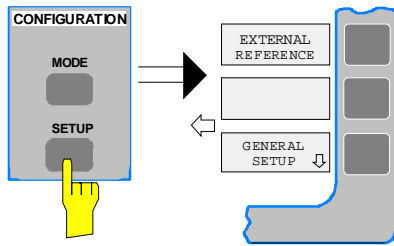

Call *SETUP-GENERAL SETUP* menu

- Press the *SETUP* key in the *CONFIGURATION* field.

The *SETUP* menu is opened.

-
- Press the *GENERAL SETUP* softkey.

The *GENERAL SETUP* submenu is opened and the current settings of the instrument parameters are displayed on the screen in the form of tables.

Selecting the external monitor mode

- Press the *MONITOR CONNECTED* softkey.

The softkey is in color to indicate that the external monitor mode is activated. The external monitor displays the controller screen.

Operation

The controller function is operated as usual with the mouse and keyboard. The measuring instrument (displayed on the instrument screen) can be operated with both the softkeys and keys of the instrument.

Toggle between screens

By activating (clicking) the window "R&S Analyzer Interface" at the controller the mouse and keyboard are allocated to the measurement screen. The mouse and keyboard are allocated to the controller when the window is deactivated.

Connecting a Printer

Caution:

The printer may be connected only when the instrument is switched off (STANDBY)

- Notes:**
- The installation of some printer drivers is possible only under the administrator identification (see section "Controller Function").
 - After the installation, the "Service Pack" of Windows NT is to be re-installed, see "New Installation of Windows NT Software".
 - To ensure that the instrument performs an autologin, the user identification is to be reset to "instrument" after the next power-up, see section "Controller Function".
 - If bad printouts are produced after installing the printer driver, it is recommended to obtain the latest drivers from the printer manufacturer (eg via Internet). Experience has shown that printer problems are thus solved in most cases.

The instrument provides an option for connecting up to three different printers to provide screen hardcopy.

The interfaces can also be used for printing in the controller mode. The output formats "WMF" (Windows Metafile) and "Clipboard" are preset. A large number of output devices can be connected under Windows NT after installing suitable printer drivers.

The output devices supported by the instrument can be found in the selection box *DEVICE/LANGUAGE* in the *HARDCOPY –SETTINGS DEVICE1/2* menu (see in Chapter 4, the section "Documentation of Measurement Results"). To print out via the COM interface, the latter must be assigned the controller function in the *SETUP - GENERAL SETUP* menu (owner = OS).

Chapter 8 describes the connector interfaces.

The interface connectors are located on the rear panel:



After the printer has been connected to the appropriate interface connector, the interface needs to be configured, the printer driver has to be installed and assigned to an interface.

1. Connecting the keyboard and mouse

To install and configure of printer drivers on the FSE, it is necessary to connect a keyboard to the front panel and a PS/2 mouse to the rear panel (see sections "Connecting a Mouse" and "Connecting a Keyboard").

2. Configuring of the interface

LPT1 The LPT1 needs no configuration.

Note: An external CM-ROM drive can be connected to this interface. If this is the case, one of the serial interfaces can be used for the printout.

COM1/COM2 The COM interfaces have to be assigned to the controller function (OWNER = OS) in the *SETUP - GENERAL SETUP* menu. The configuration of serial interfaces COM1 and COM2 can then be performed in the Windows NT menu *START - SETTINGS - CONTROL PANEL - PORTS*. The parameters *COM PORTS BAUDRATE, BITS, PARITY, STOPBITS, HW/SW-HANDSHAKE* must be those specified for the printer in question (see the operating manual for the output device).

Note: The serial interfaces can be used for remote control when the analyzer is made the owner (Owner = Instrument). The settings made for the serial interface in the menu *SETUP - GENERAL SETUP* overwrite the settings in the NT menu..
 However, settings in the Windows NT menu do not overwrite those of the *SETUP* menu. This means that the settings are only valid as long as the interface is assigned to the operating system.

3. Selection and installation of the printer driver

The selection and installation of the printer driver, the assignment to the interface and the setting of most of the printer-specific parameters (eg paper size) is performed under Windows NT in the *START - SETTINGS - PRINTER* menu.

4. Configuration of the connected output device

The printer connected to the instrument is configured in the *HARDCOPY DEVICE-SETTINGS DEVICE1/2* menu (key group: *HARDCOPY*, see Chapter 4, Section "Selection and Configuration of the Output Device "). The configuration of one or two output devices (*DEVICE1* and *DEVICE2*) can be entered, at least one of which must be activated for printing.

- The parameter *DEVICE/LANGUAGE* determines which printer is used.
- The parameter *PRINT TO FILE* determines if the output is written to a file.
- The parameter *ORIENTATION* sets the page format to horizontal or vertical (landscape or portrait).

Selecting the printer type automatically sets the parameters *PRINT TO FILE* and *ORIENTATION* to values which correspond to the standard mode for this printer. Other printer-dependent parameters such as *FORMFEED*, *PAPERFEED* etc., can be modified under Windows NT in the printer properties window (*START/SETTINGS/PRINTERS/SETTINGS/....*).

Table 1-1 shows the standard factory settings for the two output devices.

The factory settings of *DEVICE 1* correspond to the "WMF" (Windows Metafile) output format, with printout to a file. WMF is a common format which is used to import of hardcopies (eg of measurement windows) to other Windows applications that support this format (eg WinWord).

The factory setting of *DEVICE 2* is "Clipboard". In this setting, the printout is copied to the Windows NT clipboard. Most Windows applications support the clipboard. The clipboard contents can be directly inserted into a document with *EDIT - PASTE*.

Table 1-1 Factory settings for *DEVICE 1* and *DEVICE 2* in the *HARDCOPY-DEVICE SETTINGS* menu.

| Parameter | Parameter name | <i>DEVICE 1 settings</i> | <i>DEVICE 2 settings</i> |
|-------------------|----------------|--------------------------|--------------------------|
| Output device | DEVICE | WINDOWS METAFILE | CLIPBOARD |
| Output | PRINT TO FILE | YES | --- |
| Paper orientation | ORIENTATION | --- | --- |

In the following example, an HP DeskJet 660C printer is connected to interface LPT1 and configured as *DEVICE2* for hardcopies of the screen.

Switch off FSE.

Connect printer to the LPT1 interface .

Switch on both the FSE and the printer.

Select printer driver under Windows NT

- Press key combination <ALT> <SYSREQ>
The Windows NT screen is displayed.



- In the Start menu click on "Settings" and then "Printers".
The printer window is opened.

- Double-click "Add Printer".
The "Add Printer Wizard" window is opened. This window leads through the following printer driver installation.

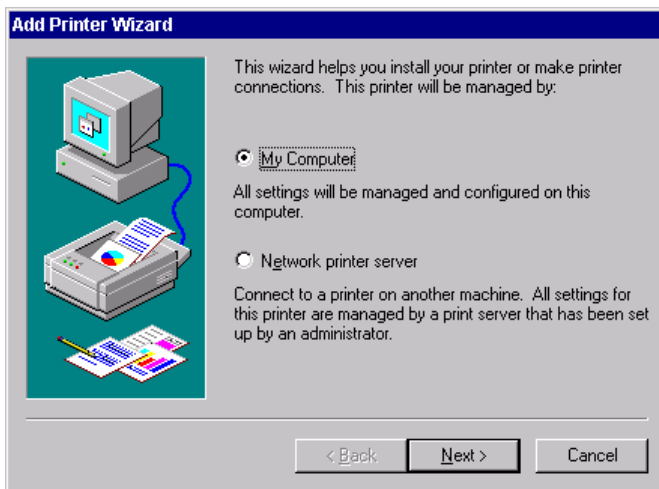

- Click first "My computer" and then "Next".
The available ports are displayed.



- Select LPT1 port.
The selection is indicated by a tick.
- "Click "Next".
The available printer drivers are displayed. The left-hand selection table indicates the manufacturers and the right-hand one the available printer drivers.

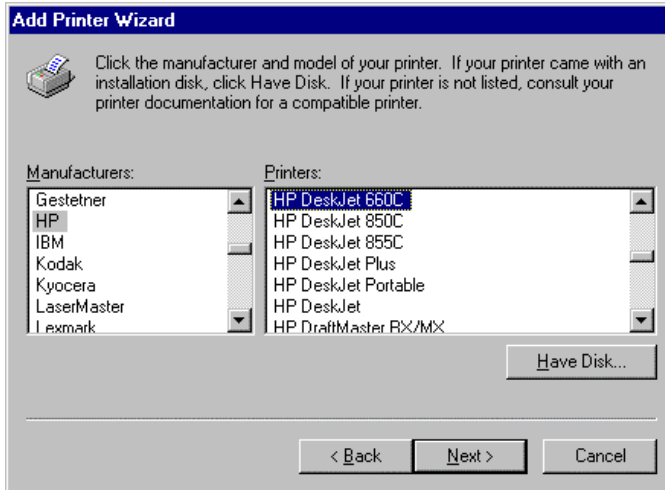

- Mark "HP" in the "Manufacturers" selection table and "HP DeskJet 660C" in the "Printers" selection table .

Note: If the required printer type is not in the list, the driver has not yet been installed. In this case click "HAVE DISK". A message box requesting to insert a disk with the printer driver will be displayed. Insert the disk, press OK and select the printer driver. After installation, Service Pack must be reinstalled (see section "Installing Windows NT Software").

- Click "Next".

The entry field for the printer name is displayed.

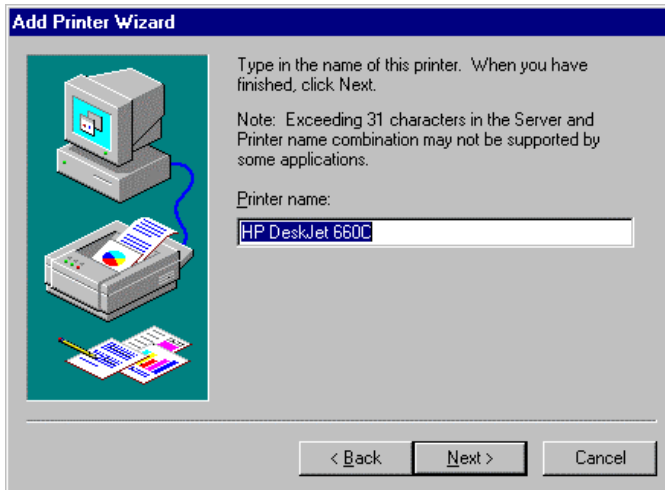

- The printer name can be modified in the entry field "Printer name" (max. 60 characters).

If one or more printers have already been installed, a query is displayed in this window to ask if the printer last installed as the default printer should be selected for the Windows NT applications (Do you want your Windows-based programs to use this printer as default printer?) "No" is preset.

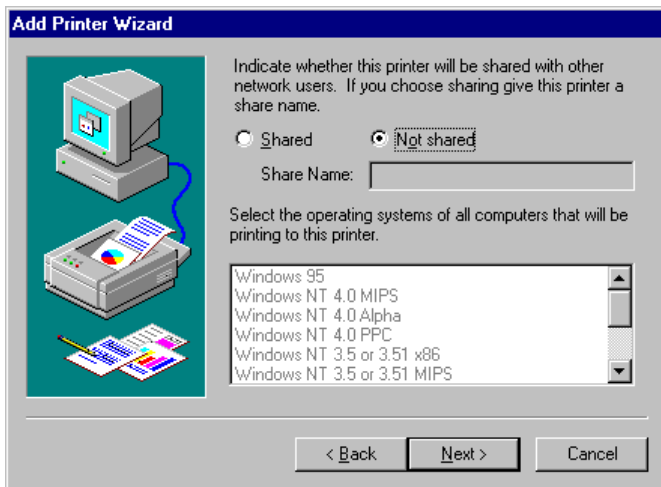

- Click "Next".

A query is displayed whether the printer is to be shared with other network users.. This query is irrelevant when installing a local printer. The answer "Not shared" is preset.

- Click "Next".

The window for printing a test page is displayed. The test page is for checking if the installation was successful.



- Switch on printer.
- Click Yes (recommended)".
- Click "Finish".

A test page is printed out if the installation was successful.

If the test page is not printed out or not completely, the Windows NT online help offers troubleshooting instructions under the entry "Printer Trouble Shooting".

Note:

If a request for the printer driver path appears after clicking "Finish", this printer installation should be performed under the administrator identification (see section "Controller Function").

Now, the instrument needs to be configured so that hardcopies of the measurement screen can be printed out on this printer.

Configuring HP DeskJet 660C.

- Click the "R&S Analyzer Interface" button.
The measurement screen is displayed.

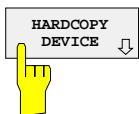
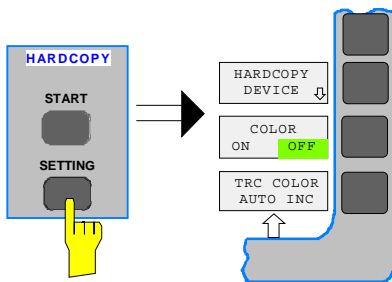

| HARDCOPY DEVICE SETTINGS | |
|--------------------------|------------------|
| Device1 | WINDOWS METAFILE |
| Print to File | YES |
| Orientation | --- |
| Device2 | CLIPBOARD |
| Print to File | --- |
| Orientation | --- |

- Press the *SETTINGS* key in the *HARDCOPY* field.
The *SETTING* menu is opened.

- Press the *HARDCOPY DEVICE* softkey.

The *HARDCOPY DEVICE* submenu is opened and the current settings of the two possible output devices are displayed in *HARDCOPY DEVICE SETTINGS*-table.

- Press the *SETTING DEVICE2* softkey.

Line *DEVICE2* is marked with the selection bar.

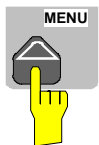
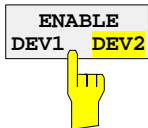
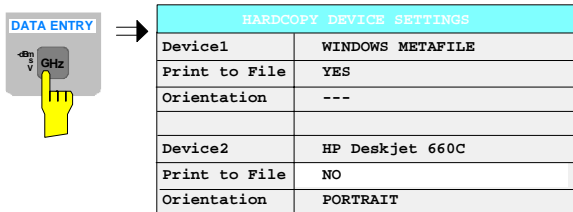
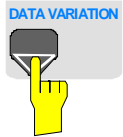
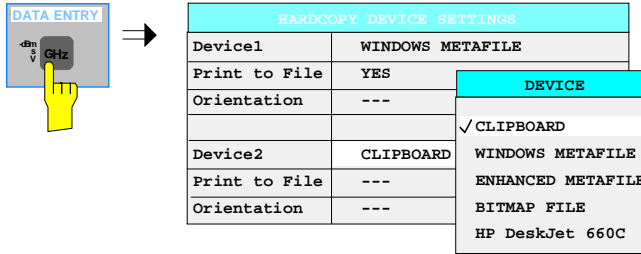

- Press one of the unit keys.

The *DEVICE* selection box is displayed on the screen. The current selection is marked by a tick and highlighted by the selection bar.

- Press the cursor key until the entry *HP DeskJet 600C* is highlighted by the selection bar.

- Press one of the unit keys.

The *DEVICE* selection box is closed and *HP DeskJet 660C* is entered in the *DEVICE2* row.

Note:

Selecting the printertype automatically sets the parameters *PRINT TO FILE* and *ORIENTATION* to standard mode values for this printer. Other printer-dependent parameters such as *PAPERSIZE*, can be modified under Windows NT in the printer properties window (*START/SETTINGS/PRINTER/SETTINGS*).

Start printing.

- Press the *ENABLE* softkey until *DEV2* is marked on the second softkey line.

Printing can then be started with the *START* key in the *HARDCOPY* menu.

Return to main menu

- Press the menu key several times.

Note: After the installation, the "Service Pack" of Windows NT is to be re-installed, see "New Installation of Windows NT Software".

Installation of a Network Printer (with option FSE-B16 only)

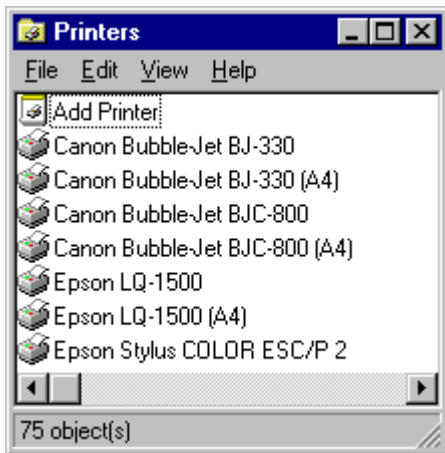

After opening the "Printers" dialog window proceed with the installation as follows:

- Double-click the "Add Printer" line.

The "Add Printer Wizard" window is opened. This window guides the user through the printer driver installation.

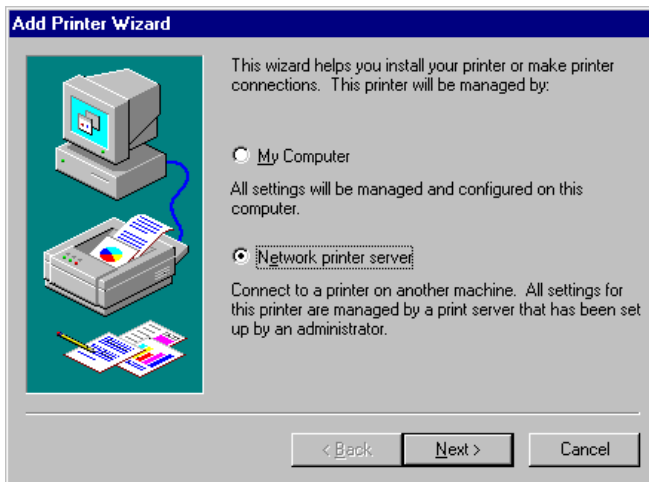

- Click "Network printer server" and then "Next".

A window to set the path to the printer server is displayed.

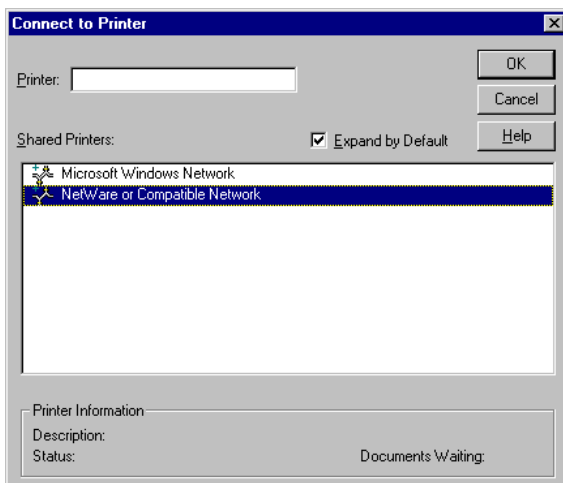

- Set the path to the desired printer server, mark it and select it with OK.
- Confirm the following request for the installation of a suitable printer driver with OK.

The list of printer drivers is displayed. The manufacturers are listed in the window at the left, the available printer drivers at the right.

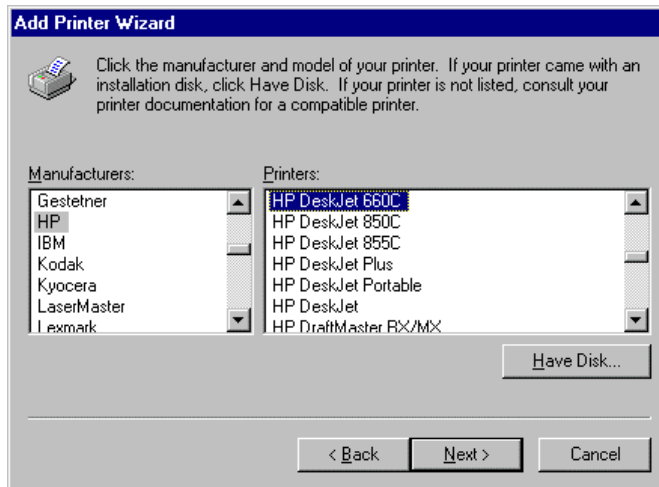

- Select the manufacturer in the "Manufacturers" window and then the printer driver in the "Printers" window.

Note:

If the required type of output device is not included in the list, the driver has not yet been installed. In this case click on button "HAVE DISK". A message box requesting to insert a disk with the corresponding printer driver will be displayed. Insert the disk, press OK and select the required printer driver.

- Click "Next"

If one or more printers are already installed, a prompt is displayed in this window to ask if the printer last installed as default printer should be selected for the Windows NT applications ("Do you want your Windows-based programs to use this printer as default printer?"). The default selection is "No".

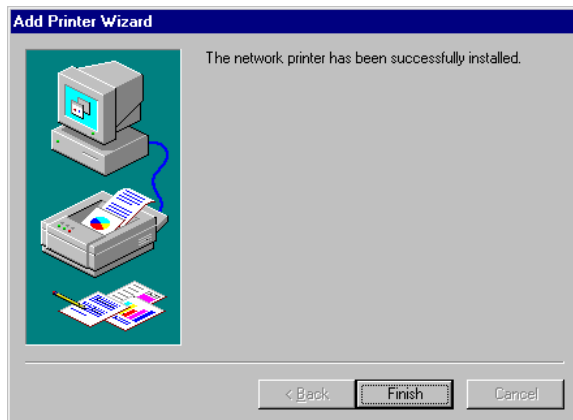

- Start the printer driver installation with "Finish".

Note:

If a prompt for the printer driver path appears after pressing "Finish", the Service Pack must be re-installed after this printer installation (see Chapter 1, section "Installing Windows NT Software").

After installation, the instrument has to be configured for printout with this printer in the *HCOPY - SETTINGS* menu.

Finally, Service Pack x must be re-installed (see section "Installing Windows NT Software").

Connecting a CD-ROM Drive

**Caution:**

The CD-ROM may only be connected when the instrument is switched off (STANDBY). If this is not observed correct operation of the CD-ROM and the instrument cannot be guaranteed.

- Notes:**
- The installation of a CD-ROM is possible only under the administrator identification (see section "Controller Function").
 - After the installation, the "Service Pack" of Windows NT is to be re-installed, see "New Installation of Windows NT Software".
 - To ensure that the instrument performs an autologin, the user identification is to be reset to "instrument" after the next power-up, see section "Controller Function",

The instrument is fitted with a rear-panel interface LPT1 for the connection of a CD-ROM drive.

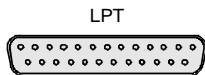

The following CD-ROM drives are supported:

- MICROSOLUTIONS BACKPACK External CD-ROM.
- FREECOM IQ DRIVE
- ADAPTEC Parallel SCSI Adapter + SCSI CD-ROM

After connection, the CD-ROM drive is to be installed under Windows NT.

Switch off FSE.

Connect CD-ROM drive to interface LPT1 of the instrument and to AC power source.

Switch on FSE.

Administrator identification

- Press key combination <ALT> <SYSREQ>
The Windows NT screen is displayed.

-
- Call the logout window with "Shut Down" in the "Start" menu.

-
- Mark entry "Shut down and log on as a different user".

-
- Press the "Shift" key and click button "Yes" at the same time.

The login window is displayed.

-
- Enter "administrator" under "name" and "894129" under "password", confirm entry with "OK".

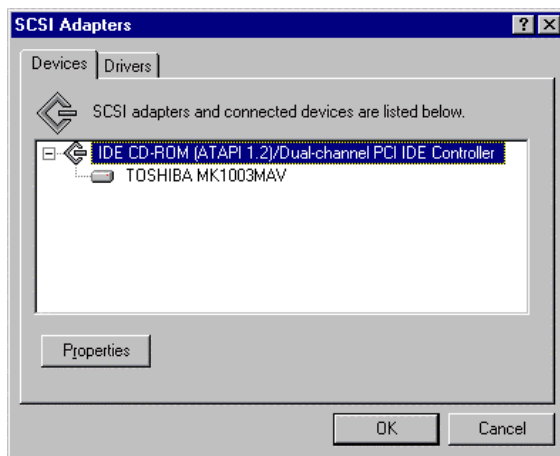

Select driver under Windows NT

- In the Start menu press first "Setting" and then "Control Panel".

The system control window is opened.

-
- Double-click "SCSI Adapters".

The "SCSI Adapters" window is opened.

-
- Click the "Driver" index card and then button "Add".

The list of installed drivers is displayed.



-
- Click "Have Disk".

This window leads through the following installation.

Note: After the installation, the "Service Pack" of Windows NT is to be re-installed, see "New Installation of Windows NT Software."

Firmware Update

The installation of a new firmware version can be performed using the built-in diskette drive and does not require opening the analyzer. The firmware update kit contains several diskettes. The installation program is called up in the *CONFIGURATION - SETUP* menu.

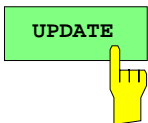
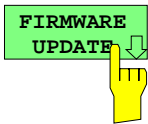
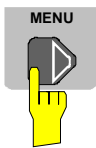
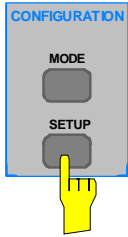

The installation can be cancelled.



Insert diskette 1 into the drive.

Call SETUP-GENERAL SETUP menu

- Press the *SETUP* key in the *CONFIGURATION* field.

The *SETUP* menu is opened.

- Change to the right-hand menu using the menu key.
-

- Press the *FIRMWARE UPDATE* softkey.

The submenu is opened.

- Press the *UPDATE* softkey.

The installation program starts and leads the user through the remaining steps of the update.

- Press the *RESTORE* softkey.

The previous firmware version is restored.

Installing Windows NT Software

The driver software and the Windows NT system settings are exactly adapted to the measurement functions of the instrument. Correct operation of the instrument can, therefore, be guaranteed only if the software and hardware used is released or provided by Rohde & Schwarz.

The use of other software or hardware may cause the FSE to malfunction.

The latest list of software authorized for use on the FSE can be obtained from your nearest Rohde&Schwarz agency (see list of addresses).

After each software installation requiring the administrator identification, "Service Pack" of Windows NT must be re-installed (also with administrator identification; see section "Controller Function"):

Re-installing Service Pack

- In the Start menu click "Run".
The entry window opens.

Service Pack 5:

- Enter "C:\SP5\I386\UPDATE\UPDATE" into the command line and start installation with "OK".
The following window leads through the installation.

Service Pack 3:

- Enter "C:\SP3\I386\UPDATE" into the command line and start installation with "OK".
The following window leads through the installation.

Options

This section describes options FSE-B17, Second IEC/IEE Interface, FSE-B16, Ethernet Interface.

- Note:**
- Option FSE-B13, 1 dB Attenuator, is described in Chapter 4, Section 'Level Display/RF Input'
 - Options FSE-B8 to B12, Tracking Generator, and FSE-B3, TV Demodulator, are described in Chapter 4, Sections 'Tracking Generator' and 'TV Demodulator'
 - For a description of options FSE-B7, Vector Signal Analysis, and FSE-B21, External Mixer Output, see manuals of options.

Option FSE-B17 – Second IEC/IEEE Interface

- Notes:**
- The installation of option FSE-B17 is possible only under the administrator identification (see section "Controller Function").
 - After the installation, the "Service Pack" of Windows NT is to be re-installed, see "New Installation of Windows NT Software".
 - To ensure that the instrument performs an autologin, the user identification is to be reset to "instrument" after the next power-up, see section "Controller Function".
 - Interface "COM2" is no longer available after installation of option FSE-B17.

Besides the instrument external devices can also be controlled via the IEC/IEEE bus using the optional 2nd bus interface FSE-B17 and the computer function for instrument. The interface software permits IEC/IEEE-bus commands to be included in user programs. The installation instructions are enclosed with the option.

Installing the software

The operating software is already installed and need not be loaded from the driver diskettes which serve as backup diskettes.

The driver must be loaded on the start-up of Windows NT. To do this, enter the type of board, configure the board and enter the parameters for the connected equipment. If the option is factory fitted, all this has been done in the factory.

The following parameters may not be changed after selection on configuration of the board:

```
Board Type .....AT-GPIB/TNT
Base I/O Address .....02C0h
Interrupt Level .....3
DMA Channel .....5
Enable Auto Serial Polling...No
```

For further parameters, refer to manual for the board.

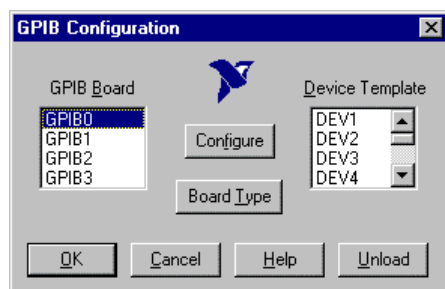

Selecting the board type

- Click "Start" in the task bar.
- Click consecutively "Settings", "Control Panel" and "GPIB" in this sequence.

The "GPIB Configuration" menu for selecting the board type and configuring the board is opened.
- Click button "Board Type".

The "Board Type" menu for selecting the board type is opened.

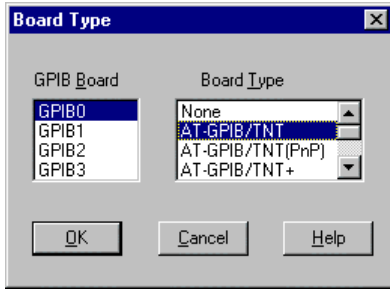

- Mark "GPIB0" in the "GPIB Board" list.
- Mark "AT-GPIB/TNT" in the "Board Type" list.
- Confirm the selection with "OK".

The "GPIB Configuration" menu is displayed again.

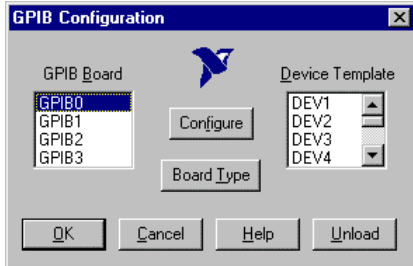

- Click button "Configure".

The "GPIB0 (AT-GPIB/TNT)" menu for configuring the board is opened.

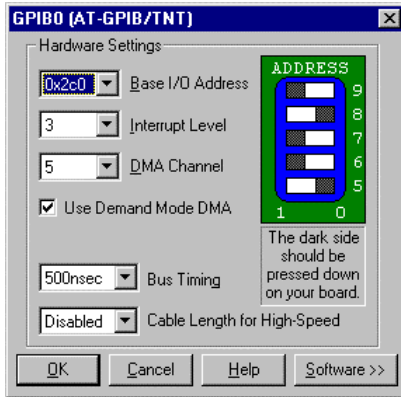

Configuring the board

- Set "3" in the "Interrupt Level" list.
- Click button "Software".

The menu is extended.

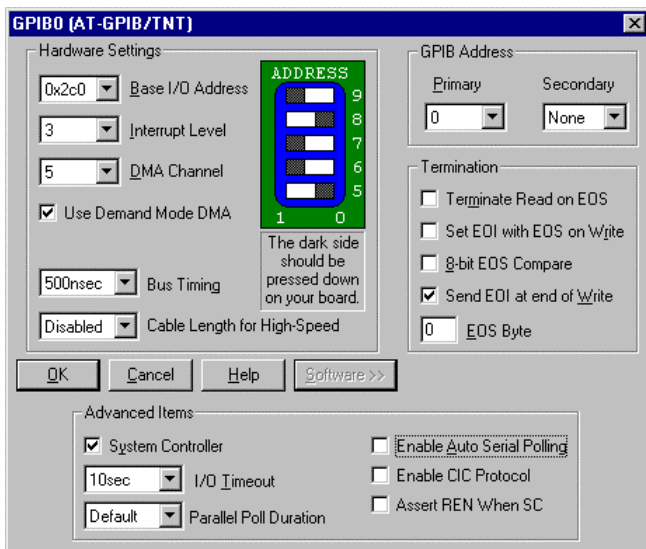

- Deactivate (= no tick) "Enable Auto Serial Polling" in the "Advanced Items" field.

- Quit the menu with "OK".

The "GPIB Configuration" menu is displayed again.

Note:

The settings of the following parameters should not be no longer modified.

```
Board Type ..... AT-GPIB/TNT
Base I/O Address ..... 02C0h
Interrupt Level ..... 3
DMA Channel ..... 5
Enable Auto Serial Polling .. No
```

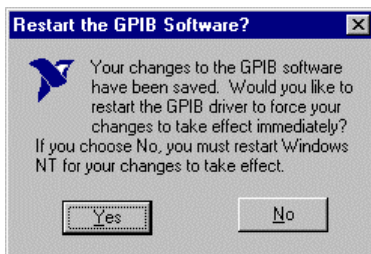
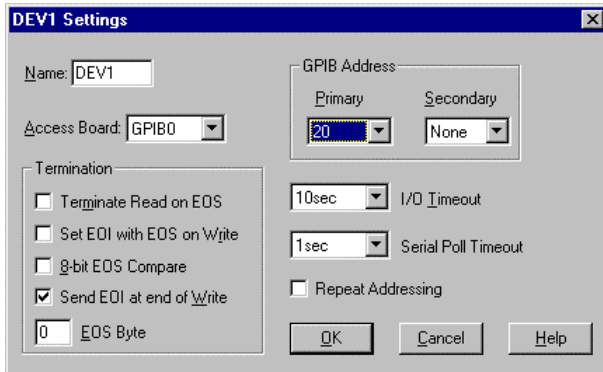
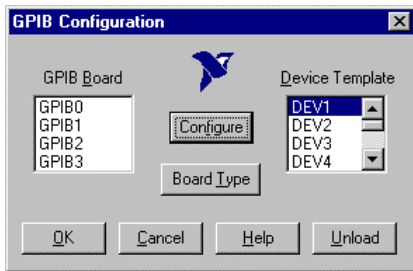

Setting the parameters for the connected equipment

- Mark the instrument in the "Device Template" list and confirm selection with "OK".

The "DEV.. Settings" menu is opened.

- Perform the settings for the selected unit in the "DEV.. Settings" menu.

The logic name for the instrument is preset with DEV1 and address 20. See board manual for further units.

Note: When assigning logic names to connected equipment note that these names do not correspond to the directory names under DOS.

- Terminate setting with "OK".

The query asking if the GPIB software should be re-started is displayed.

- Select "No".

- Re-start controller with Start-Restart in the task bar.

After the controller has been re-started, the settings for the GPIB interface are effective.

Note: After the installation, the "Service Pack" of Windows NT is to be re-installed, see "New Installation of Windows NT Software".

Use of DOS Programs

When using DOS programs, driver GPIB-NT.COM should be loaded. For this to take place, the line `device=C:\PROGRA~1\NATION~1\GPIB\NI488\DosWin16\Gpib-nt.com` has to be activated in the file `C:\WINNT\SYSTEM32\CONFIG.NT`. If the option is factory fitted, this line will have been entered in the factory.

Operation

The second IEC/IEEE-bus interface corresponds physically to that of the instrument (see Chapter 8). If the instrument is to be controlled via the IEC/IEEE bus, a bus cable must be plugged to both bus connectors. The interface can be driven under DOS/WINDOWS3.1/95/NT by R&S software (FS-K3, Order No. 1057.3028.02, etc.) or by user-written software. The handling of IEC/IEEE-bus commands in user programs is described in the manual for the card.

The files are in directory `C:\Program Files\National Instrument\GPIB\NI488`.

Option FSE-B5 - FFT Filter

Option FFT Filter FSE-B5 is a firmware option. It has to be enabled by a keyword.

Prerequisites

1. Keywords

The keyword is printed on a label which is part of the equipment supplied and has to be stuck to the rear of FSE.

2. Hardware

The modification state of module DIGITAL IF has to be either $\text{MODIF INDEX} > 5$ or $\text{MODIF INDEX} = 5$ and $\text{HW CODE} \geq 6$. The modification state can be checked in the module list *INSTALLED COMPONENTS* in menu *INFO HARDWARE+OPTIONS*.

3. Firmware

The modification state of the firmware has to ≥ 1.62 . The modification state can be checked in table *FIRMWARE VERSION* in menu *INFO FIRMWARE VERSIONS*.

Enabling the option

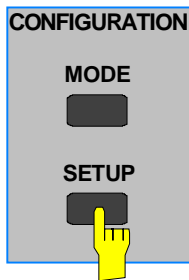

- Call up menu *SETUP* by pressing the *SETUP* key.

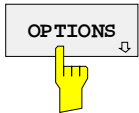

- Call up submenu *OPTIONS* by pressing the *OPTIONS* softkey. Table *FIRMWARE OPTIONS* is displayed, listing the installed options.



- Activate the entry field by pressing the *ENABLE NEW OPTION* soft key.

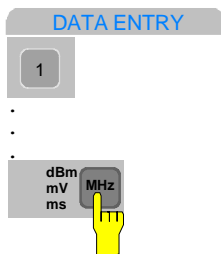

- Enter the 10-digit keyword via the numeric keypad and terminate the entry by pressing one of the unit keys.

Now option FFT filter is listed in table *FIRMWARE OPTIONS*.

Note: Message 'option key invalid' indicates an invalid entry.

Option FSE-B16 – Ethernet Adapter

With the option Ethernet Adapter FSE-B16, the device can be connected to an Ethernet-LAN (local area network). It is possible to transmit data via the network and to use the network printer. The adapter operates with a 10 MHz Ethernet in line with standards IEEE 802.3 10Base2 (Thin Ethernet, CheaperNet, BNC-Net) (B16 model 03) or 10Base5 (Thick Ethernet) (B16 model 02).

Hardware Installation



Caution:

Prior to installation contact the network administrator, especially in case of complex LAN installations since mistakes in cabling might have influence the whole network.

If the adapter is installed at the factory, it is preconfigured. In case of retrofitting, refer to the installation instructions. The hardware settings must not be modified since the functions of the device could otherwise be impaired.

The following parameters are factory-set:

I/O Addr. 300, IRQ 5, MEM D0000

The connection with the network depends on the connectors used in the network.

BNC (Thin Ethernet, CheaperNet; FSE-B16 Var. 03)

Connection

The device is looped into the LAN segment via rear-panel 2 BNC connectors.

If a cable is not connected to one of the BNC connectors, this BNC connector has to be terminated with 50 Ohm. BNC T connectors must not be used.

Network traffic



Note that the network traffic is disturbed if a segment is interrupted.

Requirements

Thin Ethernet segment requirements have to be complied with:

- maximum segment length of 185 m
- minimum distance between the connectors of 0.5 m
- maximum of 30 connectors per segment.

If components that comply with enhanced requirements are exclusively used (Ethernet Adapter FSE-B16 complies with the enhanced requirements):

- maximum length of segment of 300 m
- maximum number of connectors of 100

With repeaters used:

- maximum total length of the network of 900 m containing a
- maximum of 3 segments
- maximum of two repeaters between two connectors

AUI (Thick Ethernet; FSE B16 Var. 02)

| | |
|------------------------|--|
| Connection | The device is connected to the LAN segment using a transceiver cable (DB-15 AUI connector, not part of the equipment supplied) which is connected to the rear panel and to the transceiver. |
| Network traffic | The connection does not conflict with the network traffic. The device can also be disconnected from the network without any problems but make sure that data are not being transmitted. |
| Requirements | <p>The Thick Ethernet segment requirements have to be taken into account.</p> <ul style="list-style-type: none">- The maximum segment length should be 500 m and the distance between the connectors should at least be 2.5 m.- A maximum of 100 connectors may be used in a segment. <p>With repeaters used,</p> <ul style="list-style-type: none">- the total length of the network must not be more than 2500 m containing- a maximum of 3 segments.- There should be no more than two repeaters between two connectors. <p>If other network components are used, these conditions may vary.</p> |

RJ45 (UTP, 10BaseT, Western Connector)

| | |
|------------------------|--|
| Connection | The device is connected to the LAN segment using a RJ45 cable (not part of the equipment supplied) which is connected to the rear panel and to the network hub of the LAN segment. |
| Network traffic | This connection does not conflict with the network traffic. The device can also be disconnected from the network without any problems but make sure that data are not being transmitted. |
| Requirements | <p>Since RJ45 is not a bus but a star topology no special requirements have to be taken into account for the connection.</p> <p>The LAN requirements should be considered in the installation.</p> |

Software Installation

Data transmission within the network is by means of data blocks, the so-called packets. Besides user data other information, the so-called protocol data (transmitter, receiver, type of data, order) are transmitted. The drivers corresponding to the protocol have to be installed to process protocol information. A network operating system is required for network services (data transmission, directory services, printing in the network) and thus has to be installed.

Calling up Configuration Menu for Network Settings

-
- Click "Start" in the task bar.
 - Click consecutively "Settings", "Control Panel" and "Network".

The "Network" configuration menu for network settings is opened.

Registering the Identification

Note: It is important for the computer name to be unique in the network..

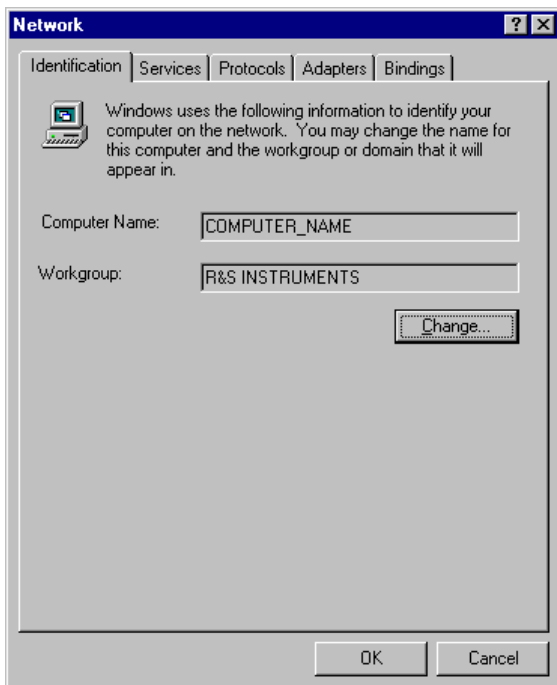

-
- Select "Identification".
 - Confirm computer and workgroup names with "OK" or enter new names in submenu "Change".

Installation and Configuration of the Driver for the Network Adapter

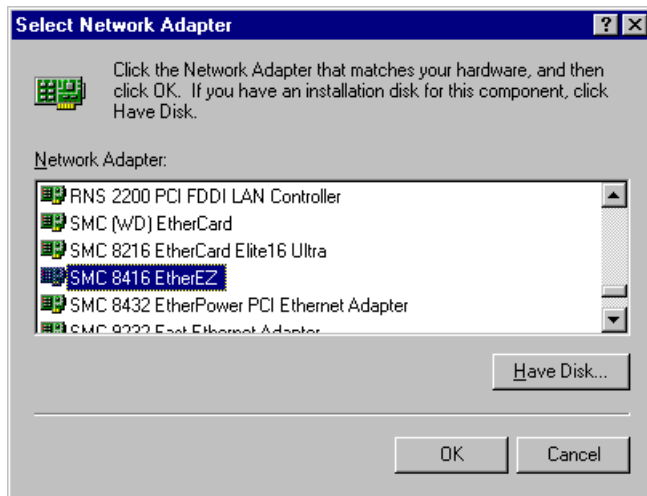

- Select "Adapter".
- Click "Add" and mark network driver "SMC 8416 EtherEZ" and select with "OK".
The query "Files.." is displayed.

- Answer it by clicking "Continue".
The "SMCEthernet Card Setup" window is displayed.

- Close the window with "OK".
Some files are copied and the network adapter is displayed under "Network Adapters".
The entry "MS Loopback Adapter" refers to a driver which ensures instrument control and should not be modified.

Note: *The network adapter settings must not be modified since this may cause problems to the instrument.*

Installation of Network Protocols

Note: *The network administrator knows which protocols are to be used..*

- Select "Protocol".
- Click "Add", mark the desired protocol and select with "OK".
This operation has to be performed several times when several protocols are selected.

- Execute the installation by clicking "Continue".

Note: *If a protocol requires further settings, they can be performed with "Properties" after marking the corresponding entry. If further settings are not possible, this field is gray.*

Installation of Network Services

To utilize the resources of the network it is necessary to install the corresponding services.

Note: The network administrator knows which services are to be used.

-
- Select "Services".
 - Click "Add", mark the desired service and select with "OK".

This operation has to be performed several times when several services are selected.

Some services are pre-installed and can be cleared with "Remove" if they are not needed.

-
- Execute the installation by clicking "Continue".

Note: If a service requires further settings, they can be performed with "Properties" after marking the corresponding entry. If further settings are not possible, this field is gray.

Terminating the Installation

-
- Quit the "Network" configuration menu for network settings with "OK".

The settings are checked and processed. Missing information is queried.

-
- Answer the query "You must shutdown..." with "Yes".

The settings are valid after computer restart.

Note: After the installation, the "Service Pack" of Windows NT is to be re-installed, see "New Installation of Windows NT Software".

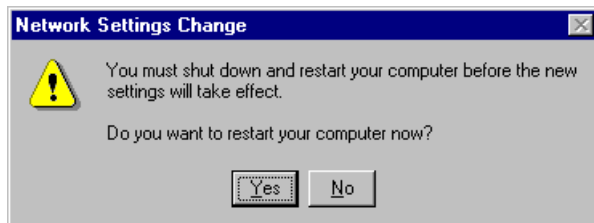

Examples of Configurations

| Network | Protocols | Services | Notes |
|--|---|-------------------------------|--|
| NOVELL Netware | NWLink IPX/SPX Compatible Transport | Client Service for NetWare | The "Frame Type" used under "Protocols - Properties" should be set. |
| IP networks (FTP, TELNET, WWW, GOPHER, etc.) | TCP/IP Protocol | Simple TCP/IP Services | An "IP Address" unambiguous in the network should be set under "Protocols - Properties". |
| MICROSOFT network | NetBEUI Protocol or TCP/IP Protocol | Workstation Server | A name unambiguous in the network should be registered under "Identification - Computer Name". |

Operation

After installing the network operating system it is possible to transfer data between the device and other computers and to use printers in the network. A precondition for network operation is the authorization to use network resources. Resources may be access to the file directories of other computers or the use of a central printer. The network or server administrator will grant the authorizations. The network name of the resource and the corresponding authorization are required. Passwords protect the resources against improper use. A user name is normally assigned to every authorized user. The user also has a password. Resources may then be assigned to the user. The type of access, i.e. whether data are only read or also written as well as a shared access to data has to be defined. Other types are possible depending on the network operating system.

NOVELL

Operating system NETWARE from NOVELL is as server-supported system. Data transfer between the individual workstations is not possible. Data transfer is between workstation computers and a central computer, the server. This server provides storage capacity and the connection to the network printers. Like under DOS, the data on a server are organized in directories and are offered to the workstation as virtual drives. A virtual drive on a workstation is like a hard disk and data can be processed accordingly. This is called drive mapping. Also network printers can be addressed as normal printers.

Network operating system NOVELL is available in two forms: NETWARE 3 and NETWARE 4 NDS. In the previous version NETWARE 3, each server manages its own resources itself and is independent. A user has to be managed separately on each server. For NOVELL 4 NDS, all resources are managed in the NDS (NOVELL DIRECTORY SERVICE). The user only has to log in once and gains access to the resources released for him. The individual resources and the user are managed as objects in a hierarchical tree (NDS TREE). The position of the object in the tree is called CONTEXT for NETWARE and must be known in order to access the resources.

MICROSOFT

For MICROSOFT, data can be transferred between workstations (peer-to-peer) but also between workstations and servers. The servers can provide access to individual files as well as the connection to network printers. Like under DOS, the data on a server are organized in directories and are offered to the workstation as virtual drives. A virtual drive on a workstation is like a hard disk and data can be processed accordingly. This is called drive mapping. Also network printers can be addressed as normal printers. A connection to DOS, WINDOWS FOR WORKGROUPS, WINDOWS95, WINDOWS NT is possible.

Installing a user

After the network software has been installed, the instrument logs with an error message during the next start-up since there is no user "Instrument" (= user identification for NT autologin) in the network. It is therefore necessary to install a user which should be the same for Windows NT and for the network. The network administrator is responsible for the installation of new users in the network.

Note: *The installation of new users is possible only under the administrator identification (see section "Controller Function").*

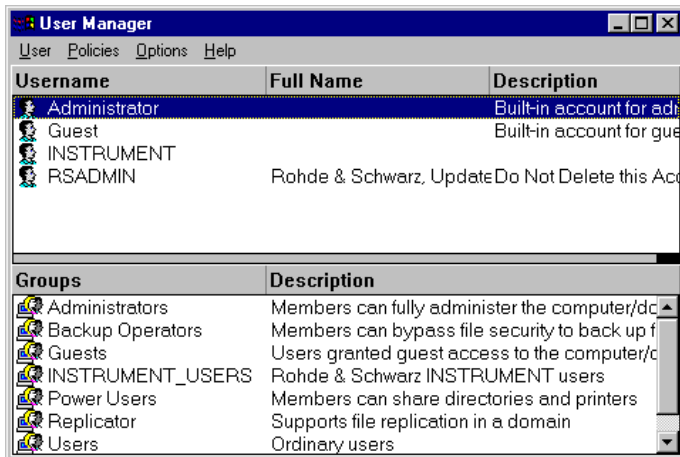

- Click "Start" in the task bar.
- Click consecutively "Programs" "Administrative Tools (Common)" and "User Manager".

The "User Manager" menu is opened.

- Click "User" and select "New User".

The menu "New User" for entering user data is opened.

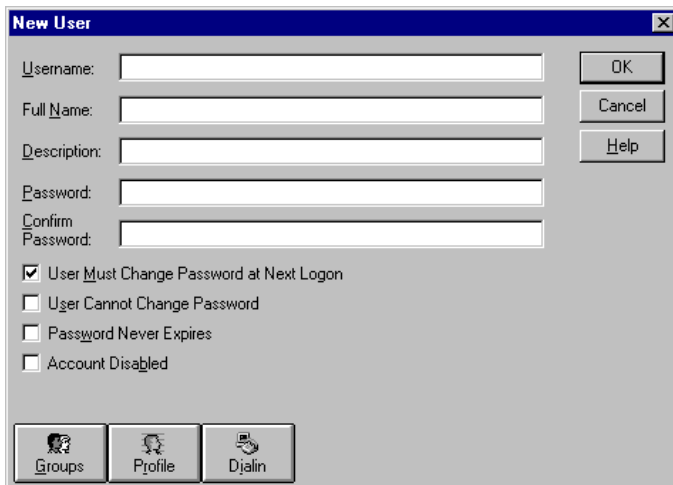

- Fill in the lines "Username", "Password" and "Confirm Password" and confirm the entry with OK.

The user data should correspond to the network settings.

Only NOVELL network: Configure NOVELL Client

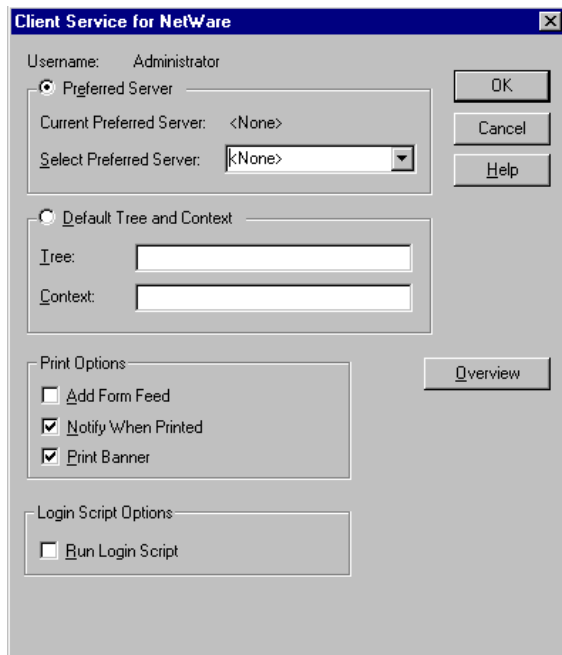

- Click "Start" in the task bar.
- Click consecutively "Settings", "Control Panel", "CSNW".

NOVELL 3.x

- Click "Preferred Server".
- Under "Select Preferred Server" select the NOVELL server for which the user has been installed.

NOVELL 4.x

- Click "Default Tree and Context" .
- Enter the NDS Tree under "Tree" and, under "Context", the hierarchical path for which the user has been installed.

Note: *These specifications can be obtained from the network administrator.*

Login in the Network

Network login is automatically performed with the operating system login. A prerequisite is that the user name and the password are the same under Windows NT and in the network.

Use of Network Drives

- Click "Start" in the task bar.
- Click consecutively "Programs" and "Windows NT Explorer".
- Click "Network" line in the "All Directories" list.

A list of available network drives is displayed.

- Click "Tools" and "Map Network Drive".
In the list "Shared Directories:" the network paths available in the network are displayed.
- Mark the desired network path.

- Select the drive under "Drive:"
- Activate "Reconnect at Logon:" if the link is to be automatically established at each unit start.
- Connect the network path to the selected drive with "OK".

The user name and the password are queried. The drive is then displayed in the "All Directories" list of Explorer.

Note: Only drives for which an authorization is available may be connected.

Disconnect link:

- Click "Tools" and "Disconnect Network Drive" in Explorer.
- Select under "Drive:" the drive whose connection is to be removed.
- Disconnect link with "OK". The query should be answered with "Yes".

Printing on a Network Printer

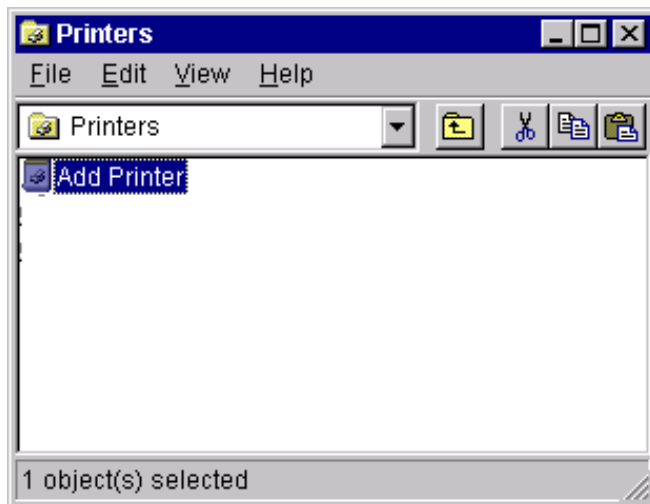

Select printer driver under Windows NT

- Press key combination <ALT> <SYSREQ>
The Windows NT screen is displayed.
-
- In the Start menu press first "Setting" and then "Printers".
The printer window is opened.

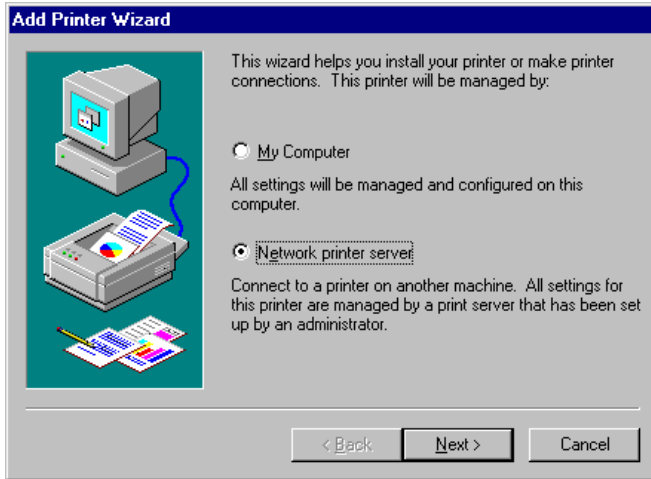

- Double-click line "Add Printer".

The "Add Printer Wizard" window is opened. This window leads through the following printer driver installation.

- Click first "Network Printer Source" and then "Next".

The list of available network printers is displayed.

- Mark the printer and select with "OK".

The available printer drivers are displayed. The left-hand selection table indicates the manufacturers and the right-hand one the available printer drivers.

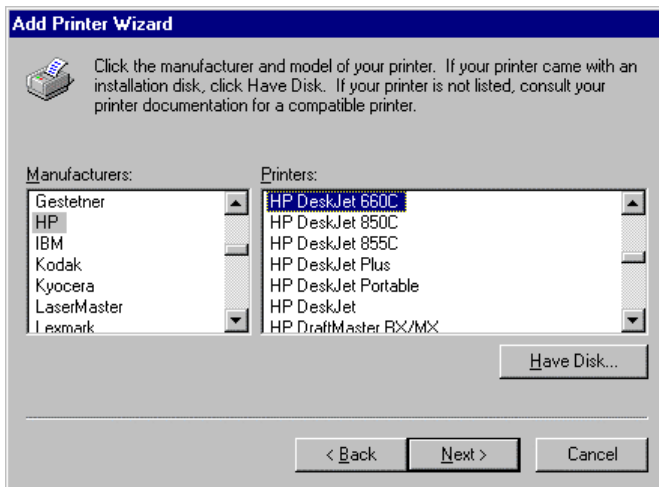

- Mark the manufacturer in selection table "Manufacturers" and then the printer driver in selection table "Printers".



- Click "Next".

The window for starting a test page is displayed. The test print is for checking if the installation was successful.

- Switch on printer.
- Click Yes (recommended)".
- Click "Finish".

A test page is printed out if the installation was successful.

If the test page is not printed out or not completely, the Windows NT online help offers troubleshooting instructions under the entry "Printer Trouble Shooting".

The instrument has to be configured with this printer for the printout of the measurement screen. This configuration is described in this chapter in the section "Connecting an Output Device".

Server Function

With the server function data can be provided on the instrument for use in other computers. This is possible only in the MICROSOFT network. The server function is released after network installation as standard. If this is not required, it should be deactivated, see "Installation of Network Services".

The availability of instrument data in the network is controlled by releases. The release is a property of a file or of a directory. To grant a release, the object is to be marked in "Windows NT Explorer" and pressed by the right-hand mouse key. The release is performed under Properties -> Sharing by selecting "Shared As". Other computers can then access these objects with the names allocated under "Share Name". The online help gives further information on the network operation.

TCP/IP

The TCP/IP protocol allows files to be transmitted between different computer systems. A program running on both computers is required to control the data transfer. The same operating or file system need not be used by the two partners. A file transfer is possible between DOS/WINDOWS and UNIX, for example. One partner has to be configured as host the other as client or vice versa. The system performing several processes at the same time (UNIX) will normally be the host. The usual file transfer program used for TCP/IP is FTP (File Transfer Protocol). An FTP host is installed as standard on most of the UNIX systems.

After installing the TCP/IP services, a terminal link can be established with "Start" - "Programs" - "Accessories" - "Telnet" or a data transmission with FTP using "Start" - "Run" "ftp" - "OK". Thus, all controller systems can be accessed which support these universal protocols (UNIX, VMS, ...).

Further information is given in the NT online help which can be called up with "Help".

FTP

For a complete description of the functions and commands see the FTP documentation.

Establishing a connection

➤ Click "Start" and then "Run" in the task bar.

The program is started with the DOS command

```
FTP
```

The following command sets up the connection:

```
OPEN <xx.xx.xx.xx>
```

xx.xx.xx.xx = IP address, e.g. 89.0.0.13

File transmission

To transmit a file to the target system, the following command is used:

```
PUT <file name>
```

file name = name of file e.g. DATA.TXT.

To call a file from the target system, the following command is used:

```
GET<file name>
```

file name = name of file e.g. SETTING.DAT.

```
TYPE B
```

allows the transmission of files in the BINARY format, no conversion is performed.

```
TYPE A
```

allows the transmission of files in the ASCII format. Thus, control characters are converted so that the text files can be read on the target system, too.

Examples:

```
PUT C:\AUTOEXEC.BAT
```

sends the AUTOEXEC.BAT file to the target system.

```
LCD DATA
```

changes to subdirectory DATA in the computer function.

```
CD SETTING
```

changes to the subdirectory SETTING on the target system.

Changing directories

The command

```
LCD <path>
```

changes the directory as the corresponding DOS command.

```
LDIR
```

lists the directory.

These commands refer to the computer function of the instrument. If the 'L' preceding the commands is omitted, they apply to the target system.

Start-Up - Instruments with MS DOS[®] Controller or without Controller



Important Note:

Before turning the instrument on, it must be observed that the following conditions are fulfilled:

- *instrument covers are in place and all fasteners are tightened,*
- *fan openings are free from obstructions,*
- *signal levels at the input connectors are all within specified maximums,*
- *signal outputs are correctly connected and not overloaded.*

Non-observance may cause damage to the instrument .

Unpacking the Instrument

After the instrument has been removed from its packaging, insure that all deliverable items are present as follows:

- FSE spectrum analyzer
- AC power cable
- operating manual

Now check the instrument for visible mechanical damage. If damage is present, promptly inform the delivery firm that delivered the instrument. In case damage is found, retain the carton and the packing materials.

Instrument Setup

The instrument is designed for use under general laboratory conditions. The ambient conditions required at the operational site are as follows:

- The ambient temperature must be in the range of + 5 to + 45 °C.
- All fan openings must be unobstructed and the air exhaust at the rear panel and at the side-panel perforations must not be covered. The distance to the wall should be at least 10 cm.
- The mounting surface should be flat.

19" Rack Installation



Important Note:

For rack installation, insure that the air flow at the side-panel perforations and the air exhaust at the rear panel are not obstructed.

The instrument may be mounted in a 19" rack by using the rack adapter kit ZZA-95 (order number: 396.4911.00). The installation instructions are included in the adapter kit.

EMI Protection Measures

In order to prevent electromagnetic interference (EMI), the instrument may be operated only when all covers are correctly in place. Only adequately shielded signal and control cables may be used (see recommended accessories).

Connecting to AC Power

The FSE is equipped with an AC voltage selection feature and will automatically set itself according to the applied AC voltage (range: 90 to 132 VAC and 180 to 265 VAC, 47 to 440 Hz). The AC power connector is located on the rear panel (see below).

- Connect the instrument to the AC power source using the AC power cable delivered with the instrument.

AC Power Line Fuses

The FSE is protected by two fuses as specified on the power supply name-plate. The fuses are located in a removable fuse holder which is located between the AC power switch and the AC power connector (see below).

Instrument On/Off

AC power switch on the rear panel

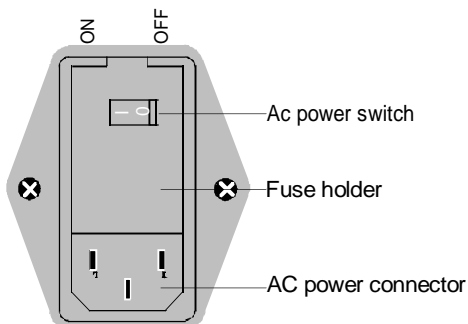

Power On/Off

- Depress the AC Power Switch to the desired position ON/OFF.

After turn-on (position ON), the instrument is in the ready state (STANDBY) or in operation dependent upon the position of the ON/STANDBY switch located on the instrument front panel (see below).

Note: The AC power switch may remain ON continuously. Switching to OFF is only required when the instrument must be completely removed from the AC power source.

Switching to OFF (position OFF) removes all instrument circuitry from the AC power source.

ON/STANDBY switch on the front panel

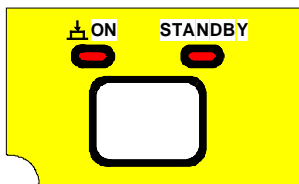

Caution:



In standby mode, the AC power voltage is present within the instrument.

Standby

- ON/STANDBY switch is not depressed.

The yellow LED (STANDBY) is illuminated. The DC power supply is supplied with power and the quartz oven is maintained at normal operating temperature.

Operation

- ON/STANDBY is depressed.

The green LED (ON) is illuminated. The instrument is ready for operation. All modules within the instrument are supplied with power.

Battery-Powered Memory

The FSE is equipped with a battery-powered read/write memory (CMOS-RAM) where instrument settings are saved at power-off. After each power-on, the FSE is reloaded with the operational parameters which were active just prior to the last power-off (STANDBY or AC power OFF).

A lithium battery is used to supply power to the CMOS-RAM. When the battery is depleted (expected life is approx. 5 years), any data stored in CMOS-RAM will be lost. In this case, the factory standard setup is loaded at turn-on. For changing batteries please contact the representative of our company responsible for you.

Functional Test

After turning on the AC power, the FSE returns the following message to the display screen:

```
Analyzer BIOS
Rev.x.y

Copyright
Rohde & Schwarz
Munich

Booting
```

After appearance of the above message, a self-test of the digital hardware is performed. Any errors which occur in self-test are transferred as ASCII text to the printer interface (LPT). Thus, an error diagnosis can be carried out, even for serious failures. A check of the data contents of the spectrum analyzer is performed in self calibration (CAL, CAL TOTAL key) The individual results of the calibration (PASSED / FAILED) can be displayed in the calibration menu.

With the aid of the built-in self-test functions (INFO key, SELFTEST softkey), the functional integrity of the analyzer can be verified and/or defective modules can be localized.

Connecting a Mouse



Caution:

The mouse may only be connected when the instrument is switched off (STANDBY). Otherwise, correct operation of the mouse and instrument cannot be guaranteed.

In order to ease manual operations, the FSE provides an option for connecting a mouse to a PS/2 mouse (MOUSE) or a serial interface (COM1 or COM2) connector.

During measurement operation, softkeys, tables and data input fields may also be controlled via the mouse. With the installed option FSE-B15, the mouse can be selectively assigned to measurement instrument operation, computer operation or both modes of operation. If the option FSE-B15 is not installed, then the mouse can only be assigned to measurement instrument operation.

The control functions for the mouse are described in Chapter 3 in the section "Mouse Operations". This section also contains a list in which the screen display elements for mouse control of the corresponding softkeys and push buttons of the instrument are described. Chapter 8 contains the interface description.

The Microsoft mouse is the supported mouse type and is available under option PS-B1 (order number 1006.6359.02). The mouse connectors are located on the rear panel.

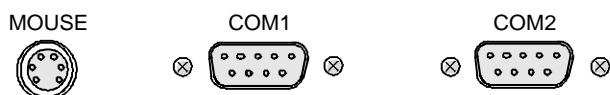

After connection of the mouse, the selected interface must be configured and the mouse assigned to either single or dual mode of operation.

The configuration is performed according to menu *SETUP-GENERAL SETUP* (key group: *CONFIGURATION*, see in Chapter 4, the section "Preliminary Setup and Interface Configuration").

- The parameter *MOUSE INTERFACE* configures the selected interface.
- The parameter *MOUSE OWNER* assigns the mouse to either single or dual mode of operation.

In the following illustrative example, the mouse is connected to the PS/2 interface and is assigned to the dual mode of operation.

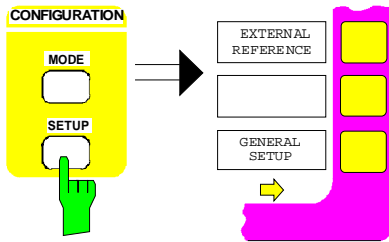

Select *SETUP-GENERAL SETUP* menu

- Press the *SETUP* key in the *CONFIGURATION* key group.

The *SETUP* menu is opened.

- Press the *GENERAL SETUP* softkey.

The *GENERAL SETUP* sub-menu is opened and the current settings of the general instrument parameters are displayed in tabular form on the display screen.

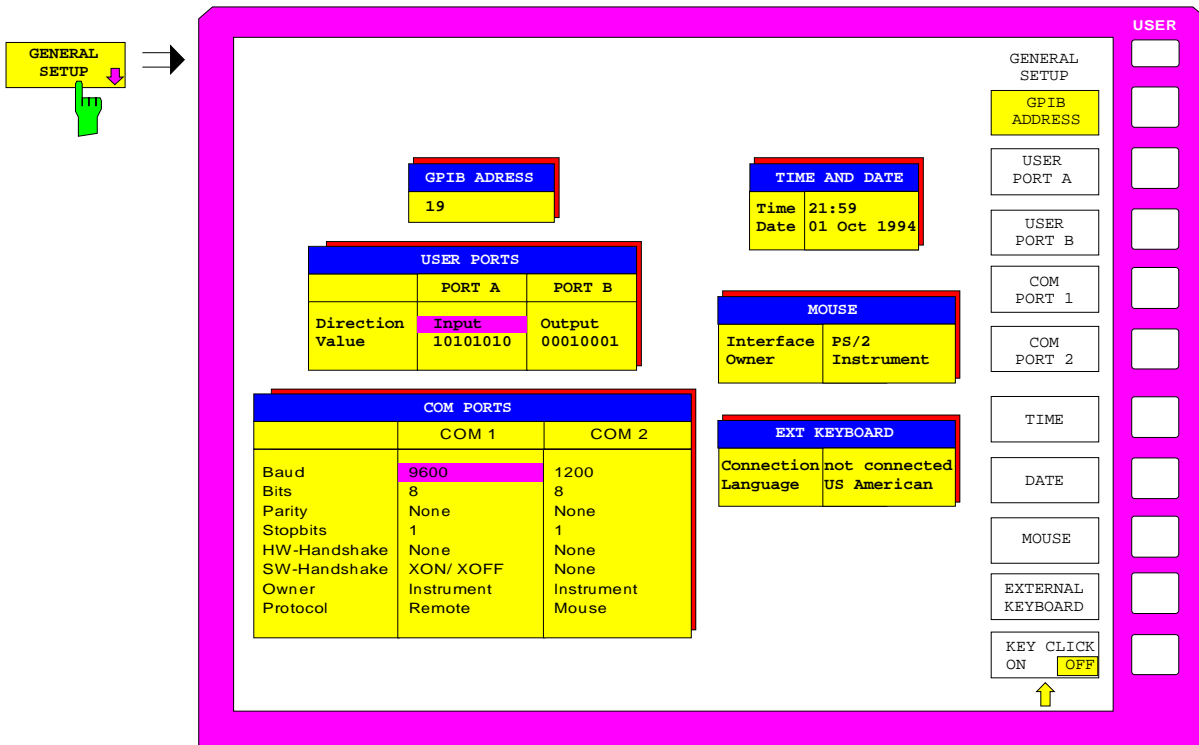

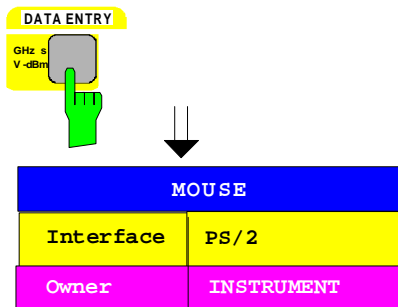
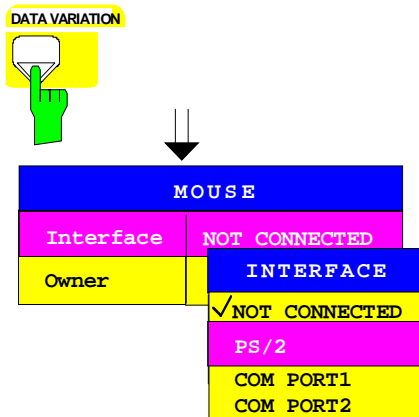
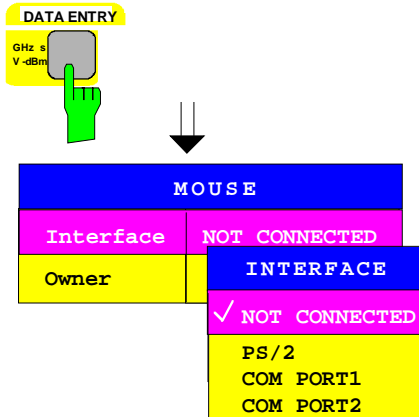
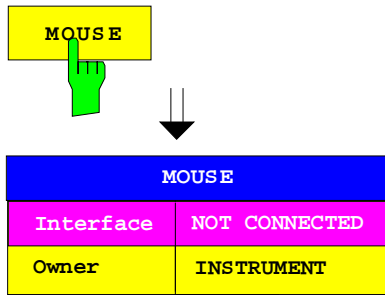

Select interface

- Press the *MOUSE* softkey.

The *INTERFACE* parameter in the *MOUSE* table is marked by the selection bar.

- Press one of the units keys.

The *INTERFACE* selection box appears on the display screen. The current state (*NOT CONNECTED*) is indicated by a check mark and the selection bar is in the background.

- Press the cursor key  until the entry PS/2 is indicated by the selection bar.

- Press one of the units keys.

The *INTERFACE* selection box is closed, the setting PS/2 is entered in the *MOUSE* table and the selection bar is automatically set to the *OWNER* parameter.

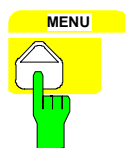
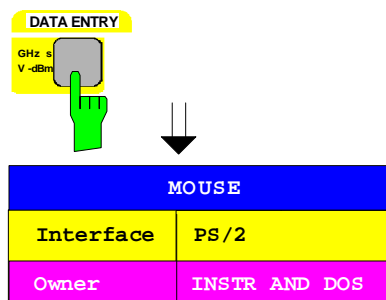
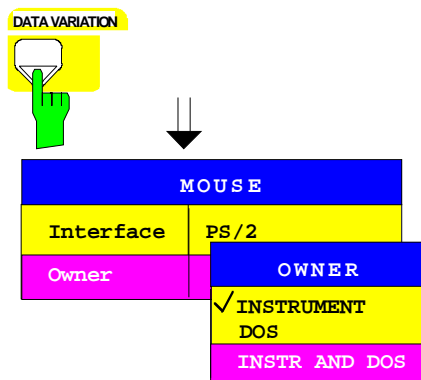
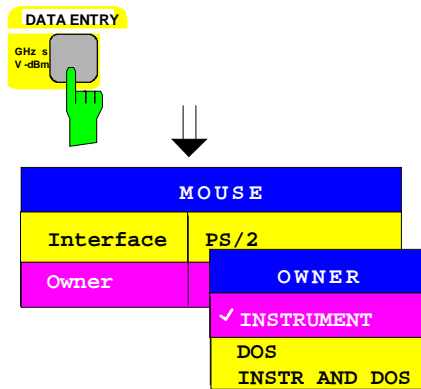

Assign mouse mode

- Press one of the units keys.

The OWNER selection box appears on the display screen. The current state (INSTRUMENT) is indicated by a check mark and the selection bar is in the background.

- Press the cursor key  until the entry *INSTR AND DOS* is indicated by the selection bar.

- Press one of the units keys.

The OWNER selection box is closed and the setting *INSTR AND DOS* is entered in the MOUSE table.

The mouse is now installed and is available in both the measurement instrument and DOS modes.

Return to main menu

- Press the menu-change key several times.

Connecting an External Keyboard

**Caution:**

The keyboard may only be connected when the instrument is switched off (STANDBY). Otherwise, correct operation of the keyboard cannot be guaranteed.

The FSE provides an option for connecting an external PC keyboard to the 5-pin DIN connector at the rear panel.

During measurement operations, the keyboard simplifies the input of commentary text, filenames, etc. If the option FSE-B15 (computer function) is installed, the keyboard has the usual DOS-mode functions.

Note: Using the key combination <ALT><S-Abf> (German keyboard) or <ALT><SYSREQ> (US-keyboard), the representation on the display screen can be rapidly toggled between the measurement instrument and the DOS display formats.

Chapter 3 contains a list which describes the assignment of the FSE front-panel key functions to the key codes of the external keyboard as well as special key combinations used for quick operations. Chapter 8 contains the interface description.

The keyboard connection (KEYBOARD) is located on the rear panel.



After connecting the keyboard, the connection must be entered into the instrument and the key assignments for measurement instrument operations must be determined.

The configuration takes place in the menu *SETUP-GENERAL SETUP* (key group: *CONFIGURATION*, see in Chapter 4, the section "Preliminary Setup and Interface Configuration").

- The parameter *EXT KEYBOARD CONNECTION* informs the instrument that an external keyboard is connected.
- The parameter *EXT KEYBOARD LANGUAGE* sets the keyboard language definition for measurement instrument operation (*US-AMERICAN* or *GERMAN*).

Note: During measurement instrument operation, the key combination <ALT> <F1> can be used to toggle the language definition.

In the following illustrative example, the instrument is informed that a keyboard has been connected. The GERMAN keyboard definition is selected.

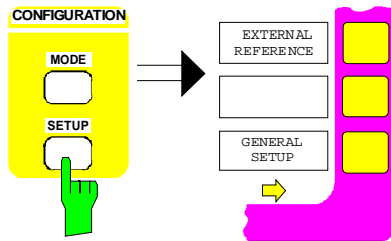

Call SETUP-GENERAL SETUP menu

- Press the *SETUP* key of the *CONFIGURATION* key group.
The *SETUP* menu is opened.

- Press the *GENERAL SETUP* softkey.

The *GENERAL SETUP* sub-menu is opened and the current settings of the general instrument parameters are shown in tabular form on the display screen.

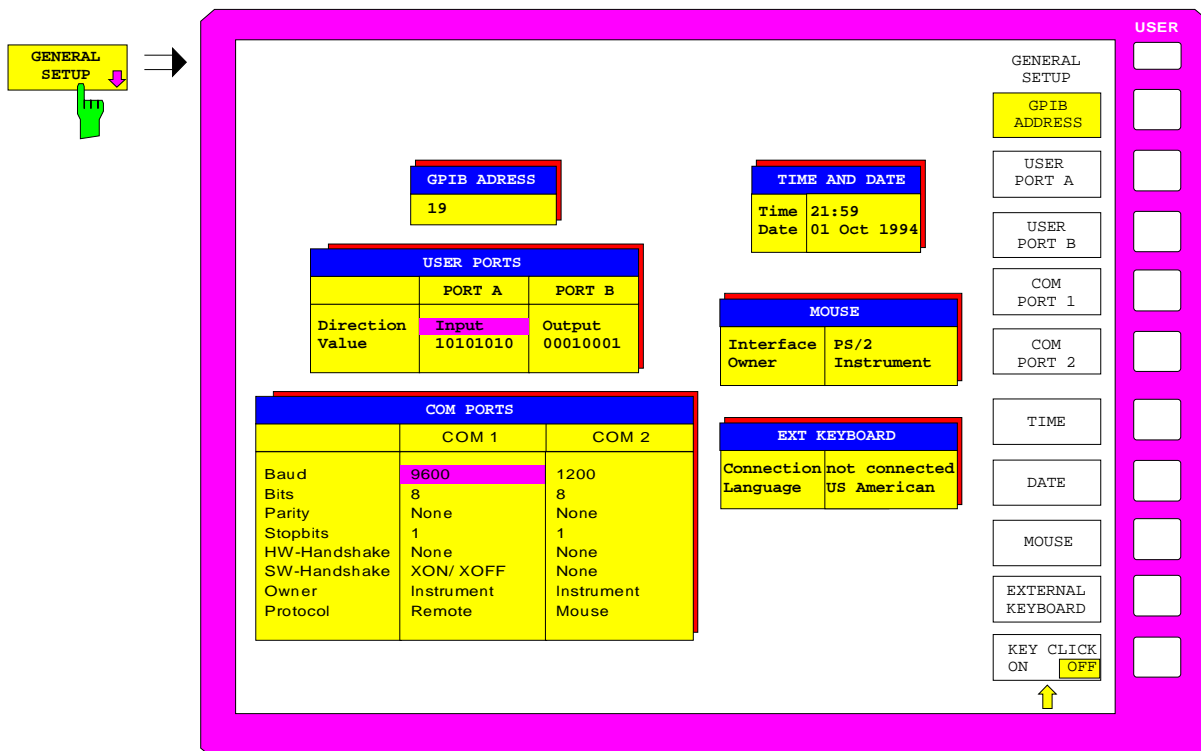

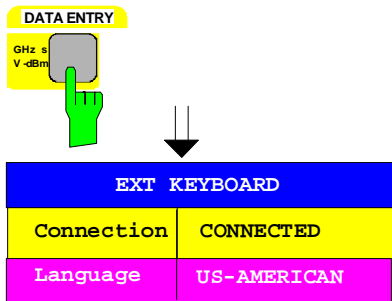
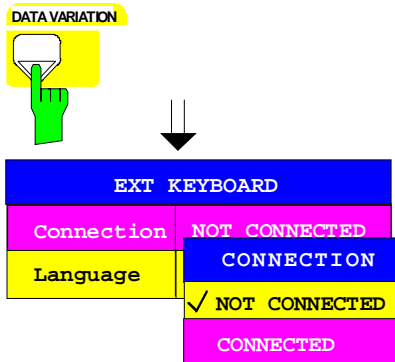
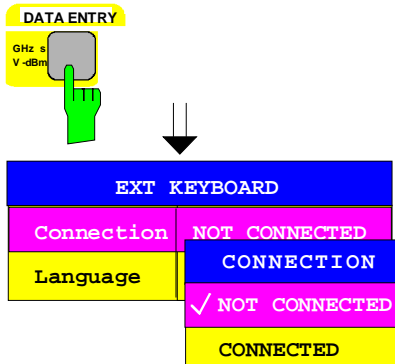
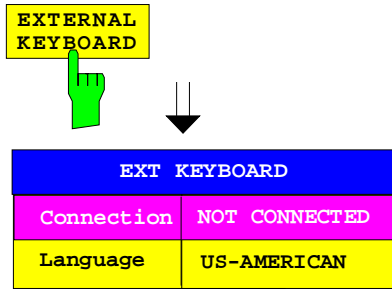

Setup keyboard connection

- Press the *EXTERNAL KEYBOARD* softkey.

The *CONNECTION* parameter in the *EXT KEYBOARD* table is marked by the selection bar.

- Press one of the units keys.

The *CONNECTION* selection box appears on the display screen. The current state (*NOT CONNECTED*) is indicated by a check mark and the selection bar is in the background.

- Press the cursor key  until the *CONNECTED* entry is indicated by the selection bar.

- Press one of the units keys.

The *CONNECTION* selection box is closed, the setup *CONNECTED* is entered in the table, *EXT KEYBOARD* is entered and the selection bar is automatically set to the *LANGUAGE* parameter.

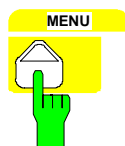
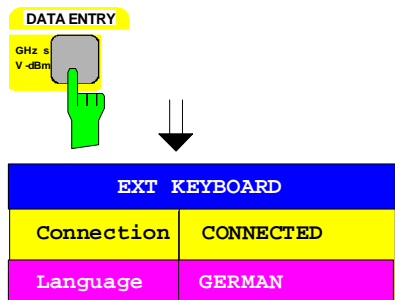
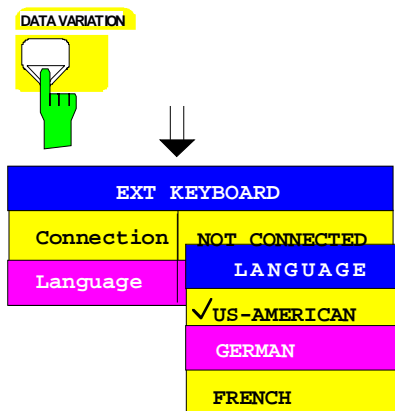
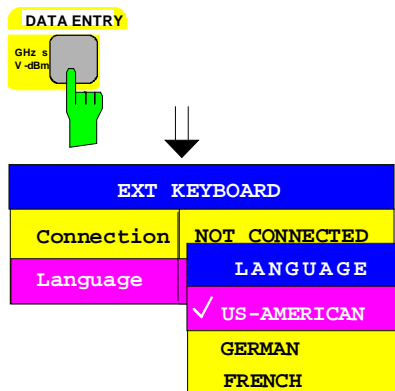

Select German keyboard

- Press one of the units keys.

The *LANGUAGE* selection box appears on the display screen. The current state is indicated by a check mark and the selection bar is in the background.

- Press the cursor key  until the *GERMAN* entry is indicated by the selection bar.

- Press one of the units keys.

The *LANGUAGE* selection box is closed and the *GERMAN* setting is entered in the *EXT KEYBOARD* table.

Note: This setting is valid only for the measurement instrument mode. The keyboard assignment in DOS mode is independently set by using the corresponding MS-DOS command.

Return to MAIN MENU

- Press the menu-change key several times.

Connecting an Output Device



Caution:





The output device may be connected only when the instrument is switched off (STANDBY)

The FSE provides an option for connecting up to four different output devices to allow printing a hard copy of the display screen. The output devices supported by the FSE can be found in the selection box *DEVICE/LANGUAGE* in the *HARDCOPY –SETTINGS DEVICE1/2* menu (see in Chapter 4, the section "Documentation of Measurement Results").

Chapter 8 contains the interface description of the connectors.

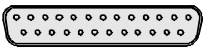
The interface connectors are located on the rear panel (see Table 1-2).

Table 1-2 Interface Connectors for Output Devices

| | | | | |
|---------------------------------|--|---|--|--|
| Rear panel interface connectors | <p>LPT</p>  | <p>COM1</p>  | <p>COM2</p>  | <p><SCPI> IEC625</p>  |
| Name in instrument control | LPT1 | COM1 | COM2 | GPIB1 |

After connection of the output device to the appropriate interface connector, the configuration of the interface as well as the output device must be entered and the output device must be assigned to the interface.

The configuration of the selected interface (COM1, COM2 or GPIB1) is performed according to the *SETUP-GENERAL SETUP* menu (key group: *CONFIGURATION*, see in Chapter 4, the section "Preliminary Setup and Interface Configuration").

Note: Interface LPT1 cannot be configured. If the option FSE-B15, computer function, is installed, LPT1 can be used for printing in both the measurement instrument mode and the computer mode. However, it can only be used for one mode at a time.

Interfaces COM1 and COM2

- The parameters *COM PORTS BAUDRATE*, *BITS*, *PARITY*, *STOPBITS*, *HW/SW-HANDSHAKE* determine the transmission parameters of the interface.

Note: The transmission parameters must agree with the specifications of the output device (see the operating manual for the output device).

- The parameter *COM PORTS PROTOCOL* informs the instrument that an output device is connected to an interface (REMOTE setting).

- The parameter *COM PORTS OWNER* assigns the interface to one or both operational modes.

Note: If printing is required in the measurement instrument mode, then this parameter must be set to *INSTRUMENT* or *INSTRUMENT AND DOS*. If, on the other hand, printing is required in computer mode (Option FSE-B15, computer function), then the parameter must be set to *DOS* or *INSTRUMENT AND DOS*.

Interface GPIB1

- The parameter *GPIB ADDRESS* passes the IEC Bus address of the output device to the instrument.

Note: *If the output device is operated in "listen only" mode, this setup may be omitted.*

The configuration of the connected output device and the assignment to the interface takes place in the *HARDCOPY DEVICE-SETTINGS DEVICE1/2* menu (key group:*HARDCOPY*, see in Chapter 4, the section "Selection and Configuration of the Output Device "). The configuration of up to two output devices (*DEVICE1* and *DEVICE2*) may be entered, of which, at least one must be activated for printing.

- The parameter *DEVICE/LANGUAGE* determines which output device is to be used.

Note: *During the selection of the printer type, it must be observed that the selected printer type and the connected output device are compatible. In case of doubt, consult the operating manual for the output device.*

- The parameter *CONNECTION* sets the interface which is to be used.

The number of additional parameters which need to be entered depends upon the selected interface and the output device used.

- The parameter *ORIENTATION* sets the page format to horizontal or vertical (portrait).
- The parameter *DEVICE RESET* determines if the output device is to be reset before each print job.
- The parameter *FORMFEED* determines if a formfeed should follow each print job.
- The parameter *PAPER FEED* specifies the paper feeder (single sheet or endless paper).

Table 1-3 shows the standard factory settings for the two output devices.

The standard factory settings for *DEVICE 1* correspond to an output device controlled by the command language HPGL, typically, a plotter connected to the IEC-Bus interface.

The standard factory settings for *DEVICE 2* correspond to a Epson printer (and compatible) connected to the parallel interface LPT.

Table 1-3 Factory settings for *DEVICE 1* and *DEVICE 2* in the *HARDCOPY-DEVICE SETTINGS* menu.

| Parameter | Parameter Name | <i>DEVICE 1 Settings</i> | <i>DEVICE 2 Settings</i> |
|------------------------------------|-----------------|--------------------------|--------------------------|
| Output Device/Descriptive Language | DEVICE/LANGUAGE | HPGL | EPSON 24 |
| Output Channel | CONNECTION | GPIB 1 | LPT |
| IEC Bus Address | GPIB ADDRESS | 4 | --- |
| Paper Format | ORIENTATION | PORTRAIT | PORTRAIT |
| Output Device Reset | DEVICE RESET | OFF | OFF |
| Formfeed | FORMFEED | OFF | ON |
| Paperfeed | PAPERFEED | MANUAL | MANUAL |

In the following illustrative examples, a Postscript printer is connected to the LPT interface.

Note: Interface LPT cannot be configured. The configuration of the other interfaces (COM1, COM2 or GPIB1) is performed according to the SETUP-GENERAL SETUP menu (key group: CONFIGURATION, see in Chapter 4, the section "Preliminary Setup and Interface Configuration").

Configure printer and connect to interface

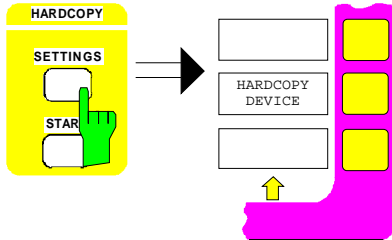

- Press the *SETTINGS* key of the *HARDCOPY* key group.
The *SETTINGS* menu is opened.

- Press the *HARDCOPY DEVICE* softkey
The *HARDCOPY DEVICE* sub-menu is opened and the current settings for the two possible output devices are displayed in tabular form on the display screen.

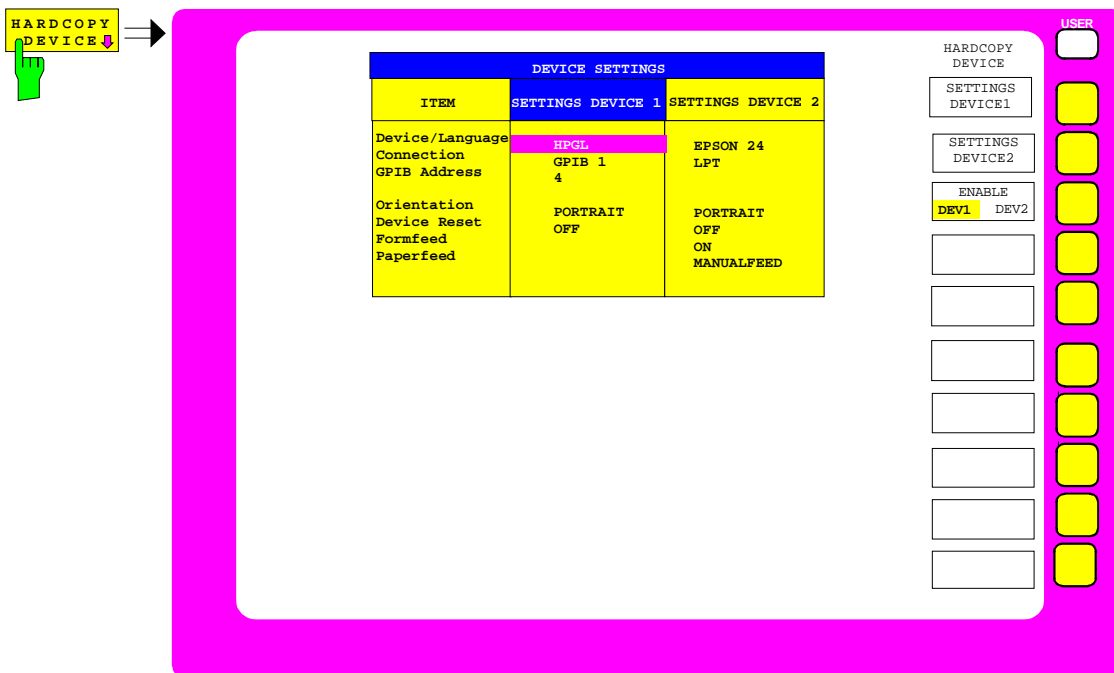

SETTINGS DEVICE2



| DEVICE SETTINGS | | |
|-----------------|-------------------|-------------------|
| ITEM | SETTINGS DEVICE 1 | SETTINGS DEVICE 2 |
| Device/Language | HPGL | EPSON 24 |
| Connection | GPIB 1 | LPT |
| GPIB Address | 4 | |
| Orientation | PORTRAIT | PORTRAIT |
| Device Reset | OFF | OFF |
| Formfeed | | ON |
| Paperfeed | | MANUALFEED |

➤ Press the *SETTINGS DEVICE2* softkey.

The current selection in the first line of the table column *SETTINGS DEVICE2* is marked by the selection bar.

DATA ENTRY



| DEVICE SETTINGS | | |
|-----------------|-------------------|-------------------|
| ITEM | SETTINGS DEVICE 1 | SETTINGS DEVICE 2 |
| Device/Language | HPGL | EPSON 24 |
| Connection | GPIB 1 | LPT |
| GPIB Address | 4 | |
| Orientation | PORTRAIT | POSTSCR |
| Device Reset | OFF | ✓ EPSON 24 |
| Formfeed | | HPPCL 4 |
| Paperfeed | | HPPCL 5 |
| | | HPGL |
| | | PCX |
| | | WMF |

SELECT DEVICE

➤ Press one of the units keys.

The *SELECT DEVICE* selection box appears on the display screen. The current selection is indicated by a check mark and the selection bar is in the background.

DATA VARIATION



| DEVICE SETTINGS | | |
|-----------------|-------------------|-------------------|
| ITEM | SETTINGS DEVICE 1 | SETTINGS DEVICE 2 |
| Device/Language | HPGL | EPSON 24 |
| Connection | GPIB 1 | LPT |
| GPIB Address | 4 | |
| Orientation | PORTRAIT | POSTSCR |
| Device Reset | OFF | ✓ EPSON 24 |
| Formfeed | | HPPCL 4 |
| Paperfeed | | HPPCL 5 |
| | | HPGL |
| | | PCX |
| | | WMF |

SELECT DEVICE

➤ Press the cursor key  until the *POSTSCR* entry is indicated by the selection bar.



| DEVICE SETTINGS | | |
|-----------------|-------------------|-------------------|
| ITEM | SETTINGS DEVICE 1 | SETTINGS DEVICE 2 |
| Device/Language | HPGL | POSTSCR |
| Connection | GPIB 1 | LPT |
| GPIB Address | 4 | |
| Orientation | PORTRAIT | PORTRAIT |
| Device Reset | OFF | OFF |
| Formfeed | | ON |
| Paperfeed | | MANUALFEED |

- Press one of the units keys.

The *SELECT DEVICE* selection box is closed and the *POSTSCR* setting is entered in the table column *SETTINGS DEVICE2*. The selection bar now indicates the current entry in the next row of the table.

Note: The *CONNECTION* parameter is set to *LPT* at the factory and, therefore, must not be changed. The selection of the printer type automatically sets the parameters *ORIENTATION*, *DEVICE RESET*, *FORM FEED* and *PAPER LENGTH* to values which correspond to a standard mode of operation with this output device.



Activate printer

- Press the *ENABLE* softkey until *DEV2* in the second softkey line is selected.

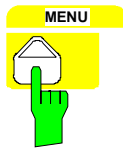

Return to main menu

- Press the menu-change key several times.

Firmware Update

The installation of a new firmware version can be performed using the built-in diskette drive and does not require opening the spectrum analyzer. The deliverable items contained in the Firmware Update Kit and the installation program call procedure may be found in the documentation accompanying the kit. The installation program then leads the user through the remaining steps of an update.

Options

Option FSE-B17 – Second IEC/IEEE Interface

Besides the FSE external devices can also be controlled via the IEC/IEEE bus using the optional 2nd bus interface FSE-B17 and the computer function for FSE (option FSE-B15). The interface software permits IEC/IEEE-bus commands to be included in user programs.

Installing the software

1. The operating software is already installed and need not be loaded from the driver diskettes which serve as backup diskettes.
2. The driver GPIB.COM must be loaded on the start-up of DOS. For this to take place, the line DEVICE = C:\AT-GPIB\GPIB.COM has to be entered in the file C:\CONFIG.SYS. If the option is factory fitted, this line will have been entered in the factory.
3. The configuration of the card can be modified with the program C:\AT-GPIB\IBCONF.EXE. The following parameters may not be changed:

Bios version < 3.0:

```
Enable Auto Serial Polling .. No
Base I/O Address ..... 02C0h
Interrupt Level ..... NONE
DMA Channel ..... 5 DMA
```

Bios version ≥ 3.0:

```
Enable Auto Serial Polling .. No
Base I/O Address ..... 02C0h
Interrupt Level ..... NONE
Channel ..... NONE
```

For further parameters, refer to manual for the card.

4. The parameters of units connected are also set with the program IBCONF.EXE. The logic designation for FSE is preset to DEV1 and the address to 20. For further equipment refer to manual for the card.

Note: *Ensure that the names assigned to the connected units are not the same as the directory names under DOS.*

Operation

The second IEC/IEEE-bus interface corresponds physically to that of FSE (see chapter 8).

If the FSE is to be controlled via the IEC/IEEE bus, a bus cable must be plugged to both bus connectors.

The interface can be driven under DOS/WINDOWS by R&S software (FSE-K3, Order No. 1057.2996.02, etc.) or by user-written software. The handling of IEC/IEEE-bus commands in user programs is described in the manual for the card.

The files for DOS in the computer function are in directory C:\AT-GPIB, those for WINDOWS in directory C:\AT-GPIBW .

Note: *The program IBIC.EXE (see manual for the card) may not be used for controlling the FSE (measuring unit section); however external units can be controlled via the bus.*

Option FSE-B5 - FFT Filter

Option FFT Filter FSE-B5 is a firmware option. It has to be enabled by a keyword.

Prerequisites

1. Keywords
The keyword is printed on a label which is part of the equipment supplied and has to be stuck to the rear of FSE.
2. Hardware
The modification state of module DIGITAL IF has to be either $\text{MODIF INDEX} > 5$ or $\text{MODIF INDEX} = 5$ and $\text{HW CODE} \geq 6$. The modification state can be checked in the module list *INSTALLED COMPONENTS* in menu *INFO HARDWARE+OPTIONS*.
3. Firmware
The modification state of the firmware has to be ≥ 1.62 . The modification state can be checked in table *FIRMWARE VERSION* in menu *INFO FIRMWARE VERSIONS*.

Enabling the option

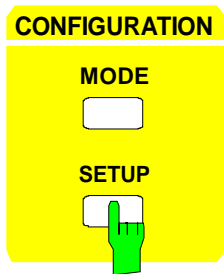

- Call up menu *SETUP* by pressing the *SETUP* key.



- Call up submenu *OPTIONS* by pressing the *OPTIONS* softkey.
Table *FIRMWARE OPTIONS* is displayed, listing the installed options.

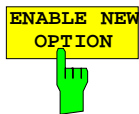

- Activate the entry field by pressing the *ENABLE NEW OPTION* softkey.

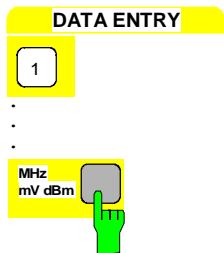

- Enter the 10-digit keyword via the numeric keypad and terminate the entry by pressing one of the unit keys.
Now option FFT filter is listed in table *FIRMWARE OPTIONS*.

Note: Message 'option key invalid' indicates an invalid entry.

Option FSE-B16 – Ethernet Adapter

With the option Ethernet Adapter FSE-B16, the device can be connected to an Ethernet-LAN (local area network). Together with the option Computer Function FSE-B15 it is possible to transmit data via the network and to use the network printer. The adapter operates with a 10 MHz Ethernet in line with standards IEEE 802.3 10Base2 (Thin Ethernet, CheaperNet, BNC-Net) (B16 model 03) or 10Base5 (Thick Ethernet) (B16 model 02). Operation without the option Computer Function FSE-B15 is not possible.

Hardware Installation



Caution:

Prior to installation contact the network administrator, especially in case of complex LAN installations since mistakes in cabling might have influence the whole network.

If the adapter is installed at the factory, it is preconfigured. In case of retrofitting, refer to the installation instructions. The hardware settings must not be modified since the functions of the device could otherwise be impaired.

The following parameters are factory-set:

I/O Addr. 300, IRQ 5, MEM CA000

The connection with the network depends on the connectors used in the network.

BNC (Thin Ethernet, CheaperNet; FSE-B16 Var. 03)

Connection

The device is looped into the LAN segment via rear-panel 2 BNC connectors.

If a cable is not connected to one of the BNC connectors, this BNC connector has to be terminated with 50 Ohm. BNC T connectors must not be used.

Network traffic



Note that the network traffic is disturbed if a segment is interrupted.

Requirements

Thin Ethernet segment requirements have to be complied with:

- maximum segment length of 185 m
- minimum distance between the connectors of 0.5 m
- maximum of 30 connectors per segment.

If components that comply with enhanced requirements are exclusively used (Ethernet Adapter FSE-B16 complies with the enhanced requirements):

- maximum length of segment of 300 m
- maximum number of connectors of 100

With repeaters used:

- maximum total length of the network of 900 m containing a
- maximum of 3 segments
- maximum of two repeaters between two connectors

AUI (Thick Ethernet; FSE B16 Var. 02)**Connection**

The device is connected to the LAN segment using a transceiver cable (DB-15 AUI connector, not part of the equipment supplied) which is connected to the rear panel and to the transceiver.

Network traffic

The connection does not conflict with the network traffic. The device can also be disconnected from the network without any problems but make sure that data are not being transmitted.

Requirements

The Thick Ethernet segment requirements have to be taken into account.

- The maximum segment length should be 500 m and the distance between the connectors should at least be 2.5 m.
- A maximum of 100 connectors may be used in a segment.

With repeaters used,

- the total length of the network must not be more than 2500 m containing
- a maximum of 3 segments.
- There should be no more than two repeaters between two connectors.

If other network components are used, these conditions may vary.

RJ45 (UTP, 10BaseT, Western Connector)**Connection**

A direct connection to a RJ45 star topology is not possible. With a MINI transceiver (AUI → RJ45) used, connection can be made via the AUI port at the rear of the device.

Network traffic

This connection does not conflict with the network traffic. The device can also be disconnected from the network without any problems but make sure that data are not being transmitted.

Requirements

Since RJ45 is not a bus but a star topology no special requirements have to be taken into account for the connection.

The LAN requirements should be considered in the installation.

Software Installation

Data transmission within the network is by means of data blocks, the so-called packets. Besides user data other information, the so-called protocol data (transmitter, receiver, type of data, order) are transmitted. The drivers corresponding to the protocol have to be installed to process protocol information. A network operating system is required for network services (data transmission, directory services, printing in the network) and thus has to be installed.

Installation of Network Drivers

a) ODI

ODI drivers have been developed by NOVELL for the network operating system NETWARE. It is an open standard so that other systems can be based on it, too. The driver system is of modular design and can thus be easily adapted to the hardware.

Files required for installation:

| | |
|-------------|------------------------------------|
| LSL.COM | (ODI drivers) |
| SMC8000.EXE | (hardware drivers for the adapter) |
| NET.CFG | (configuration file) |

The NET.CFG file comprises information required for the installation of the network drivers. It is a text file that can be generated by any editor e.g. EDIT.

At least the following information has to be contained in the NET.CFG file:

```

Link Support
  Max Stacks 8
  Buffer 12 1586
  MemPool 8192

Link Driver SMC8000
  Port 300
  Mem CA000
  Int 5
  Frame ETHERNET_II

```

Parameter `Frame ...` depends on the type of packets used in the network. The network administrator can provide information about the frame type used. With a wrong type used, problems will not occur in the network but a connection to other systems cannot be set up.

Loading the drivers

The drivers have to be loaded under DOS in the following order:

```

LSL
SMC8000

```

To allow for an automatic start, the drivers can be entered into the `C:\NETWORK.BAT` file. This batch file will be executed automatically when the device is started. The drivers can be unloaded if the programs are called up with the parameter `/U`. Unloading has to be in the reverse order.

b) NDIS

NDIS drivers are mainly used by network operating systems from MICROSOFT (DOS MS-NET, WINDOWS FOR WORKGROUPS, WINDOWS 95, WINDOWS NT). It is an open system so that other systems can be based on it, too. The driver system is of modular design and can thus be easily adapted to the hardware.

Files required for installation:

```

PROTMAN.DOS
PROTMAN.EXE
NET.EXE
NET.MSG
IFSHLP.SYS
PROTOCOL.INI
NDISHLP.SYS
NETH.MSG
WFWSYS.CFG
SMC8000.DOS      (Hardware drivers for the adapter)
SYSTEM.INI

```

Files PROTOCOL.INI and SYSTEM.INI contain information required for installing the network drivers. They are text files that can be created or modified by any editor, e.g. EDIT.

At least the following information has to be contained in the PROTOCOL.INI file:

```

[network.setup]
version=0x3110
netcard=ms$w8003e,1,MS$W8003E,3
transport=ms$nwlinknb,NWLINK
transport=ms$ndishlp,MS$NDISHLP
transport=ms$netbeui,NETBEUI
lana0=ms$w8003e,1,ms$nwlinknb
lana1=ms$w8003e,1,ms$ndishlp
lana2=ms$w8003e,1,ms$netbeui

[protman]
DriverName=PROTMAN$
PRIORITY=MS$NDISHLP

[NWLINK]

BINDINGS=MS$W8003E
[MS$NDISHLP]
DriverName=ndishlp$
BINDINGS=MS$W8003E

[NETBEUI]
DriverName=netbeui$
SESSIONS=10
NCBS=12
BINDINGS=MS$W8003E
LANABASE=1

[MS$W8003E]
DriverName=SMC8000$
irq=5
iobase=0x300
ramaddress=0xca00

[SMC8000W]
Adapters=MS$W8003E

```

At least the following information has to be contained in the SYSTEM.INI file:

```
[Network]
winnet=wfwnet/00025100
multinet=nonet
FileSharing=Yes
PrintSharing=Yes
LogonDisconnected=yes
EnableSharing=Yes
UserName=FSE
Workgroup=WORKGROUP
ComputerName=FSE
Comment=FSE
[network drivers]
netcard=smcmac.dos
transport=ndishlp.sys,*netbeui
devdir=C:\NDIS
LoadRMDrivers=No

[NWNBLINK]
LANABASE=0
```

Parameter "UserName= ..." comprises the user name for the network.
 Parameter "Workgroup= ..." comprises the user name for the network.
 Parameter "ComputerName= ..." determines the name of the device in the network.
 This name has to be unique in the network.

All drivers should be copied into a directory, e.g. C:\NDIS.

Requirements in the CONFIG.SYS file

The C:\CONFIG.SYS file has to be extended by the following line:

```
DRIVER = C:\NDIS\IFSHLP.SYS
```

To do this, the read-only attribute of the file has to be removed by the following DOS command:

```
ATTRIB C:\CONFIG.SYS -R
```

Loading the drivers

On startup of the device, the network drivers will be loaded automatically.

c) Packet Drivers

The "Packet" network driver system has been developed by universities and can be used free of charge. Many free-of-charge network operating systems (KERMIT) are based on this driver system. Although the drivers for these network cards used to be made at universities, manufacturers have now started to supply their own drivers.

File required for installation:

PKT8000.COM

Loading the drivers

The driver should be copied into a directory, e.g. C:\PACKET.

The DOS command

```
C:\PACKET\PKT8000 -i 0x7e 5 0x300 0xca00
```

starts the driver.

To allow for an automatic start, the driver can be entered into the C:\NETWORK.BAT file. This batch file will be executed automatically on the startup of the device.

Installation of Network Operating System

a) NOVELL NETWARE

ODI drivers are the precondition for NOVELL NETWARE. The access software is available in three models: NETWARE SHELL, NETWARE REQUESTER and NETWARE CLIENT 32. NETWARE SHELL allows access to NETWARE 3 servers only. The NETWARE REQUESTER allows access to NETWARE 3 as well as NETWARE 4 (NDS). NETWARE CLIENT 32 cannot run on the device.

NETWARE SHELL

Files required for installation:

IPXODI.COM

NETX.EXE

The files should be copied into the directory comprising the network drivers.

If a connection to a certain network server is requested, the name of the server can be entered into the NET.CFG file by means of the following line:

```
PREFERRED SERVER = FSESERVER
```

(FSESERVER has to be replaced by the server name in the network).

Loading the drivers

The drivers are loaded under DOS in the following order:

```
IPXODI
NETX
```

To allow for an automatic start, the drivers can be entered into the C:\NETWORK.BAT file in addition to the network drivers. This batch file will be executed automatically on the startup of the device. The drivers can be unloaded if the programs are called up with the parameter /U . Unloading has to be in the reverse order.

NETWARE REQUESTER**Files required for installation:**

```
IPXODI.COM
AUTO.VLM
BIND.VLM
CONN.VLM
FIO.VLM
GENERAL.VLM
IPXNCP.VLM
NDS.VLM
NETX.VLM
NMR.VLM
NWP.VLM
PNW.VLM
PRINT.VLM
REDIR.VLM
RSA.VLM
SECURITY.VLM
TRAN.VLM
VLM.EXE
```

The files should be copied into the directory comprising the network drivers.

Changes in the CONFIG.SYS file

In the C:\CONFIG.SYS file line

```
LASTDRIVE = V: has to be replaced by line
LASTDRIVE = Z:
```

To do this, the read-only attribute of the file has to be removed with the DOS command

```
ATTRIB C:\CONFIG.SYS -R
```

Changes in the NET.CFG file

The NET.CFG file is extended by the following lines:

```
Netware Dos Requester
NETWARE PROTOCOL = NDS BIND
FIRST NETWORK DRIVE = W
SHOW DOTS = ON
SPX CONNECTIONS = 99
IPX PACKET SIZE LIMIT = 1514
hold= off
```

If a connection to a certain network server is requested, the name of the server can be entered into the NET.CFG file by means of line

```
PREFERRED SERVER = FSESERVER
```

(FSESERVER has to be replaced by the server name in the network).

Loading the drivers

The drivers are loaded under DOS in the following order:

```
IPXODI
```

```
VLM
```

To allow for an automatic start, the drivers can be entered into the C:\NETWORK.BAT file in addition to the network drivers. This batch file will be executed automatically on the startup of the device. The drivers can be unloaded if the programs are called up with the parameter /U. Unloading has to be in the reverse order.

b) MICROSOFT NET**Drivers required**

The NDIS drivers are the precondition for the MICROSOFT NET. Other drivers are not required.

Loading the drivers

The start is via the following DOS command:

```
C:\NDIS\NET START
```

To allow for an automatic start, the command can be entered into the C:\NETWORK.BAT file. This batch will be executed automatically on the startup of the device.

c) TCP/IP

TCP/IP (Transmission Control Protocol / Internet Protocol) is not a network operating system but a standard. This standard allows to transmit data between computers using different operating systems. The services are managed by utility programs such as FTP, TELNET, KERMIT, HTTP, RSH. TCP/IP only provides services for the transport and network addressing.

Drivers required

TCP/IP can be based on the ODI or PACKET drivers. Normally, another driver providing the TCP/IP support is required. See corresponding product about the use of the drivers.

d) KERMIT

Drivers required

The data transmission program KERMIT is based on the PACKET drivers. To install KERMIT it is required to copy all the files into a directory, e.g. C:\KERMIT. The precondition for this is that an IP address is assigned to the device by the network administrator and that the Sub Net Mask for the network is known. Both addresses are in the form of four digits from 0 to 255 separated by a dot. An IP address in the network has to be unique as problems might otherwise occur. The Sub Net Mask is the same in the whole network.

Examples of IP address: 89.0.0.14

Example of Sub Net Mask: 255.255.0.0

Operation

After installing the network operating system it is possible to transfer data between the device and other computers and to use printers in the network. A precondition for network operation is the authorization to use network resources. Resources may be access to the file directories of other computers or the use of a central printer. The network or server administrator will grant the authorizations. The network name of the resource and the corresponding authorization are required. Passwords protect the resources against improper use. A user name is normally assigned to every authorized user. The user also has a password. Resources may then be assigned to the user. The type of access, i.e. whether data are only read or also written as well as a shared access to data has to be defined. Other types are possible depending on the network operating system.

NOVELL

Operating system NETWARE from NOVELL is as server-supported system. Data transfer between the individual workstations is not possible. Data transfer is between workstation computers and a central computer, the server. This server provides storage capacity and the connection to the network printers. Like under DOS, the data on a server are organized in directories and are offered to the workstation as virtual drives. A virtual drive on a workstation is like a hard disk and data can be processed accordingly. This is called drive mapping. Also network printers can be addressed as normal printers. Network operating system NOVELL is available in two forms: NETWARE 3 and NETWARE 4 NDS. In the previous version NETWARE 3, each server manages its own resources itself and is independent. A user has to be managed separately on each server. For NOVELL 4 NDS, all resources are managed in the NDS (NOVELL DIRECTORY SERVICE). The user only has to log in once and gains access to the resources released for him. The individual resources and the user are managed as objects in a hierarchical tree (NDS TREE). The position of the object in the tree is called CONTEXT for NETWARE and must be known in order to access the resources.

Logging into network

After all network drivers have been loaded and the device has established a connection with the server, a new drive W: is generated. After a change to this drive, the log in can be started with the

```
LOGIN
```

command. The user name and the password are queried.

For NOVELL 4 NDS it is necessary to set the CONTEXT beforehand using the

```
CX <context>
```

command.

Virtual drives

To generate a virtual drive on the computer function of a device, the following command is used

```
MAP [ROOT]<dr>:=<server>/,<volume>:<directory>
```

where:

| | |
|-----------|--|
| dr | drive indicator under which the virtual drive is addressed (E to P, R to V) |
| server | name of the NOVELL server on which the directory is located. |
| volume | name of the data medium on which the directory is located. |
| directory | name of the directory which is to be accessed. |

If parameter ROOT is specified, the higher directories can no longer be addressed.

Example:

```
MAP P:=VENUS/SYS:MESURE\FSE
```

causes that the directory \MESURE\FSE on hard disk SYS of server VENUS appears on the device as drive P . In drive P it is also possible to see the directory structure of MESURE. If the command is called up with the parameter ROOT, it would only be possible to access directory structures below FSE.

The

```
MAP DEL <lw>:
```

command allows drive mapping to be canceled.

Storage of device data on a server

Instead of storing device data on hard disks, they can be stored on virtual drives. To do this, it is first required to generate a virtual drive E: in the computer function. The LOADINFO file in directory d:\ has to comprise line

```
ATTACHDEVICE E_DOS AS :C: EDOS
```

to enable the device to recognize the drive. Access to E: is according to normal device functions.

Printing on a network printer

To be able to use a printer in the computer function, this printer has to be connected first with the computer function by means of the following command

```
CAPTURE L=<lpt> Q=<printer_queue>
```

where:

| | |
|---------------|---------------------------------------|
| lpt | printer port (1=LPT1, 2=LPT2, 3=LPT3) |
| printer_queue | name of printer queue. |

Example:

```
CAPTURE L=1 Q=PRINTER_FSE
```

causes printer data which are normally sent to printer port LPT1 to be routed to the network printer called PRINTER_FSE.

Hardcopy from device to a network printer

It is not possible to directly route a hardcopy from the device to a network printer. It has to be printed first into a file on the hard disk (Print to File). This file is then copied to the printer in the computer function.

This procedure is automated by the following DOS batch file:

```
START:
IF NOT EXIST C:\USER\OUTPUT.PRN GOTO START
COPY C:\USER\OUTPUT.PRN LPT1 /B
DEL C:\USER\OUTPUT.PRN
GOTO START
```

If this batch program is called up, the computer function waits until the device has generated a print file called OUTPUT.PRN, prints this file and deletes it again.

MICROSOFT

For MICROSOFT, data can be transferred between workstations (peer-to-peer) but also between workstations and servers. The servers can provide access to individual files as well as the connection to network printers. Like under DOS, the data on a server are organized in directories and are offered to the workstation as virtual drives. A virtual drive on a workstation is like a hard disk and data can be processed accordingly. This is called drive mapping. Also network printers can be addressed as normal printers. A connection to DOS, WINDOWS FOR WORKGROUPS, WINDOWS95, WINDOWS NT is possible.

Logging into network

After all network drivers are loaded and the device has established a connection with the server, a new drive W: is generated. After a change to this drive, the log in can be started with the

```
NET LOGON
```

command. The user name and the password are queried.

Virtual Drives

To generate a virtual drive on the computer function of a device, the following command is used

```
NET USE <dr>: \\<server>\<directory>
```

where:

| | |
|-----------|---|
| dr | drive indicator under which the virtual drive is addressed (E to P, R to V) |
| server | name of the server on which the directory is located. |
| directory | name of the directory which is to be accessed. |

Example:

```
NET USE P: VENUS\MESSUNG\FSE
```

causes the directory \MESURE\FSE of server VENUS to appear as drive P on the device.

Drive mapping is canceled by means of

```
NET USE <lw>: \\<server>\<directory> /DELETE
```

Storage of device data on a server

Instead of storing device data on hard disks, they can be stored on virtual drives. To do this, it is first required to generate a virtual drive E: in the computer function. The LOADINFO file in directory d:\ has to comprise line

```
ATTACHDEVICE E_DOS AS :C: EDOS
```

to enable the device to recognize the drive. Access to E: is according to normal device functions.

Printing on a network printer

To be able to use a printer in the computer function, this printer has to be connected first with the computer function by means of the following command

```
NET USE <port>: \\<server>\<printerqueue>
```

| | |
|--------------|--|
| port | printer port (LPT1, LPT2, LPT3) |
| server | name of server on which the directory is located |
| printerqueue | name of printer queue of printer |

Example:

```
NET USE LPT1: \\VENUS\PRINTER_FSE
```

uses printer data which are normally sent to printer port LPT1 to be routed to the network printer called PRINTER_FSE.

Hardcopy from device to a network printer

It is not possible to directly route a hardcopy from the device to a network printer. It has to be printed first into a file on the hard disk (Print to File). This file is then copied to the printer in the computer function.

This procedure is automated by the following DOS batch file:

```
START:
IF NOT EXIST C:\USER\OUTPUT.PRN GOTO START
COPY C:\USER\OUTPUT.PRN LPT1 /B
DEL C:\USER\OUTPUT.PRN
GOTO START
```

If this batch program is called up, the computer function waits until the device has generated a print file called OUTPUT.PRN, prints this file and deletes it again.

TCP/IP

The TCP/IP protocol allows files to be transmitted between different computer systems. A program running on both computers is required to control the data transfer. The same operating or file system need not be used by the two partners. A file transfer is possible between DOS/WINDOWS and UNIX, for example. One partner has to be configured as host the other as client or vice versa. The system performing several processes at the same time (UNIX) will normally be the host. The usual file transfer program used for TCP/IP is FTP (File Transfer Protocol). An FTP host is installed as standard on most of the UNIX systems.

Columbia University provides the KERMIT program which not only allows file transfer via networks but also via modem. KERMIT can be used free of charge. The two procedures provide safe data transmission, i.e. errors normally do not occur.

FTP

For a complete description of the functions and commands see the FTP documentation.

Establishing a connection

The program is started with the DOS command
`FTP`

The following command sets up the connection:

```
OPEN <xx.xx.xx.xx>
      xx.xx.xx.xx = IP address, e.g. 89.0.0.13
```

File transmission

To transmit a file to the target system, the following command is used:

```
PUT <file name>
      file name = name of file e.g. DATA.TXT.
```

To call a file from the target system, the following command is used:

```
GET<file name>
      file name = name of file e.g. SETTING.DAT.
```

```
TYPE B
```

allows the transmission of files in the BINARY format, no conversion is performed.

```
TYPE A
```

allows the transmission of files in the ASCII format. Thus, control characters are converted so that the text files can be read on the target system, too.

Examples:

```
PUT C:\AUTOEXEC.BAT
```

sends the AUTOEXEC.BAT file to the target system.

```
LCD DATA
```

changes to subdirectory DATA in the computer function.

```
CD SETTING
```

changes to the subdirectory SETTING on the target system.

Changing directories

The command

```
LCD <path>
```

changes the directory as the corresponding DOS command.

```
LDIR
```

lists the directory.

These commands refer to the computer function of the instrument. If the 'L' preceding the commands is omitted, they apply to the target system.

KERMIT

KERMIT comprises a large number of functions described in detail in the help file KERMIT.HLP.

Establishing a connection

The program is started by means of the DOS command

```
KERMIT
```

The

```
SET TCP/IP ADDRESS <xx.xx.xx.xx>
```

```
xx.xx.xx.xx = IP address e.g. 89.0.0.13
```

command allows to set the individual IP address.

The Sub Net Mask is set by means of

```
SET TCP/IP SUBNETMASK <xx.xx.xx.xx>
```

```
xx.xx.xx.xx= Sub Net Mask e.g. 255.0.0.0.
```

These commands can also be entered into the MSCUSTOM.INI file and will be executed automatically when KERMIT is started.

The computer to which data are to be transferred is set by means of

```
SET PORT TCP/IP <xx.xx.xx.xx>
```

```
xx.xx.xx.xx=IP address of target computer.
```

A prerequisite is that the KERMIT program on the target computer is running in the host mode.

KERMIT can be ordered via Internet in WWW (URL: <http://WWW.COLUMBIA.EDU>) from COLUMBIA UNIVERSITY for almost all operating systems.

The

```
CONNECT
```

command sets up the connection.

The

```
HANGUP
```

command allows to stop the connection and the

```
QUIT
```

command to leave the program.

Data transmission

To transmit a file to the target system, the

```
SEND <file name>
```

file name = name of file e.g. DATA.TXT

command is used. To transmit a file from the target system, the

```
GET<file name>
```

file name = name of file e.g. SETTING.DAT

command is used.

Changing directories

Like with DOS, the directory is changed by means of the

```
CD <path>
```

command and the contents of the directory is indicated by means of the

```
DIRECTORY
```

command.

These commands concern the computer function of the device. If REMOTE.. is used in front of the commands, they apply to the target system.

Examples:

```
SEND C:\AUTOEXEC.BAT
```

sends the AUTOEXEC.BAT file to the target system.

```
CD DATA
```

changes to the subdirectory DATA in the computer function.

```
REMOTE CD SETTING
```

changes to the subdirectory SETTING on the target system.

Contents - Chapter 2 "Getting Started"

| | |
|--|-------------|
| 2 Getting Started..... | 2.1 |
| Level and Frequency Measurements..... | 2.1 |
| Measurement Task..... | 2.1 |
| Important Spectrum Analyzer Functions | 2.2 |
| Sweep, Level and Frequency Measurements – Example 1 | 2.2 |
| Sweep, Level and Frequency Measurements – Example 2 | 2.6 |
| Level Measurement Accuracy | 2.8 |
| Measurement of Harmonic Separation | 2.9 |
| Measurement Task..... | 2.9 |
| Important Spectrum Analyzer Functions | 2.10 |
| Measurement Procedure - Harmonic Separation – Example 1..... | 2.11 |
| Measurement Procedure - Harmonic Separation – Example 2..... | 2.16 |
| Measurement Procedure - Harmonic Separation – Example 3..... | 2.20 |
| Measurement of Intermodulation Distortions | 2.24 |
| Measuring Task | 2.24 |
| Important Spectrum-Analyzer Functions | 2.25 |
| Measurement..... | 2.26 |
| Time-domain Measurements with Pulsed Signals | 2.31 |
| Measuring Task | 2.31 |
| Important Spectrum Analyzer Functions | 2.31 |
| Measurement..... | 2.32 |

2 Getting Started

Chapter 2 presents basic measurements performed by a spectrum analyzer to provide fast and easy access to the operation of the instrument.

Before starting any measurement with the FSE, please note the instructions given in chapter 1 for putting the instrument into operation. In chapters 3 you will find detailed information on customizing the instrument and the display.

For a systematic explanation of all menus, functions and parameters and background information refer to the reference part in chapter 4.

In the following description, each step is explained in detail using the FSE so that the instrument can be immediately used without the need for learning all of the available functions. The described measurement applications are:

- Measurement of the level and frequency of a sine wave signal.
- Measurement of harmonics.
- Measurement of third order intermodulation and determination of the intercept point.
- Zero span measurement of a pulsed signal.

All of the following examples assume the standard settings for the analyzer. These are set with the *PRESET* key in the *SYSTEM* key field. The most important standard settings are shown in Table 2-1. A complete listing of standard settings can be found in chapter 4.

Table 2-1 Important PRESET settings

| Parameter | Parameter name | Setting | | | |
|--------------------------|------------------|----------|----------|-----------|----------|
| | | FSEA | FSEB | FSEM | FSEK |
| Mode | Mode | analyzer | analyzer | analyzer | analyzer |
| Center frequency | Center Frequency | 1,75 GHz | 3,5 GHz | 13,25 GHz | 20 GHz |
| Active Freq. Meas. Range | Span | 3,5 GHz | 7 GHz | 26,5 GHz | 40 GHz |
| Reference Level | Ref Level | - 20 dBm | - 20 dBm | - 20 dBm | - 20 dBm |
| RF Attenuation | RF ATT | 10 dB | 10 dB | 10 dB | 10 dB |
| Level Display Range | Level Range | 100 dB | 100 dB | 100 dB | 100 dB |
| Resolution Bandwidth | Res Bw | 3 MHz | 3 MHz | 3 MHz | 3 MHz |
| Video Bandwidth | Video Bw | 3 MHz | 3 MHz | 3 MHz | 3 MHz |
| Sweep Time | Sweep Time | 5 ms | 5 ms | 150 ms | 225 ms |
| Trigger | Trigger | free run | free run | free run | free run |

Level and Frequency Measurements

Measurement Task

The determination of the level and frequency of a signal is one of the most frequently encountered measurement tasks typically performed by a spectrum analyzer. Usually, for the measurement of an unknown signal, the PRESET settings are initially selected. If levels above +30 dBm are expected or possible, then a power attenuator must be inserted ahead of the analyzer input. Without attenuation, these signal levels might damage or destroy the input attenuator or the input mixer.

Important Spectrum Analyzer Functions

Important parameters for level and frequency measurements are the settings for the *CENTER FREQUENCY*, the selection of the active measurement frequency range (*SPAN*) and the *MARKER* functions.

Sweep, Level and Frequency Measurements – Example 1

In this example, a signal with a frequency of 200 MHz and a level of -10 dBm are applied to the RF INPUT of the analyzer. The selection of the center frequency and the active frequency range takes place manually.

The necessary setup functions are performed almost without exception by the fixed-function keys. The menus which appear with a key can, for the most part, be ignored. In this manner, fast, key-oriented operation is possible.

The following setup steps are performed:

1. Reset the instrument.
2. Apply the test signal.
3. Set the center frequency to 200 MHz.
4. Reduce the active measurement frequency range (*SPAN*) to 1 MHz.
5. Measure the level and frequency using the marker.
6. Optimize the measurement dynamic range and reduce the level measurement error.
7. Measure the frequency with the internal frequency counter

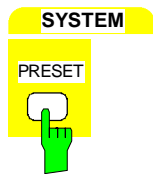

1. Reset the instrument.

- Press the *PRESET* key.
-

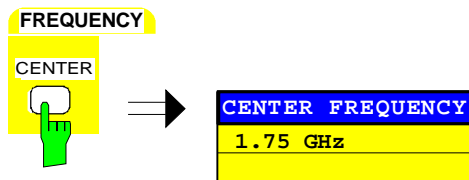

2. Connect the test signal to the RF INPUT located on the instrument front panel.

3. Set the center frequency to 200 MHz.

- Press the *CENTER* key in the *FREQUENCY* key field.

The input field for center frequency appears on the display screen.

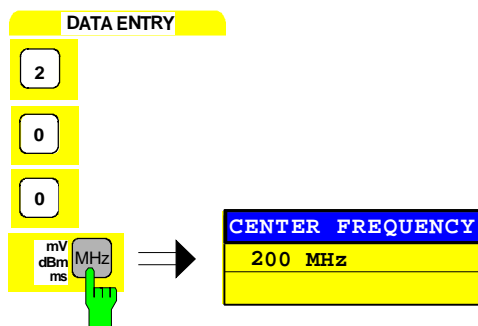

- Enter 200 via the numeric keypad and terminate with the *MHz* key.

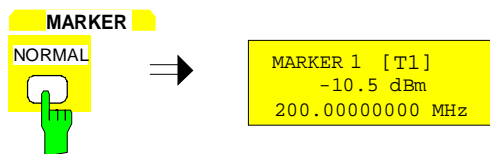
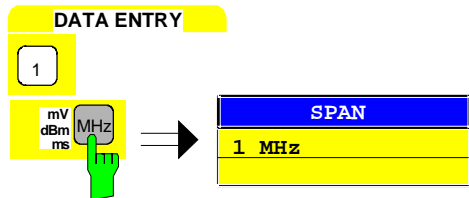
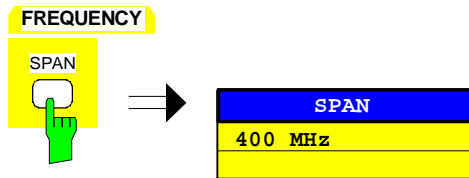

4. Reduce the measurement frequency range (SPAN) to 1 MHz.

- Press the SPAN key in the FREQUENCY key field.

- Enter 1 via the numeric keypad and terminate with the MHz key.

Note: In conjunction with the change in measurement frequency range (SPAN), the resolution bandwidth (RES BW), video bandwidth (VIDEO BW) and sweep time (SWEEP TIME) are set to new values since they are defined as coupled functions in the standard PRESET settings.

5. Measure level and frequency using the marker and read the resulting values on the display screen.

- Press the NORMAL key in the MARKER key field.

The marker jumps to the largest signal peak shown on the display screen.

Note: When the marker is switched on for the first time, it automatically performs the PEAK SEARCH function as demonstrated in this example.

If a marker was already active, the SEARCH key in the MARKER key field must be pressed in order to set the currently active marker to the displayed signal maximum.

The level and frequency measured by the marker can be read in the marker field at the upper edge of the display screen. (see Fig. 2-1).

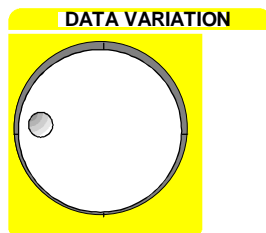

- Using the roll-key, the marker can be moved along the measured curve.

The corresponding level and frequency values appear in the marker field.

Fig. 2-1 shows the measured curve on the display screen over a 1 MHz range as well as the marker level and frequency values.

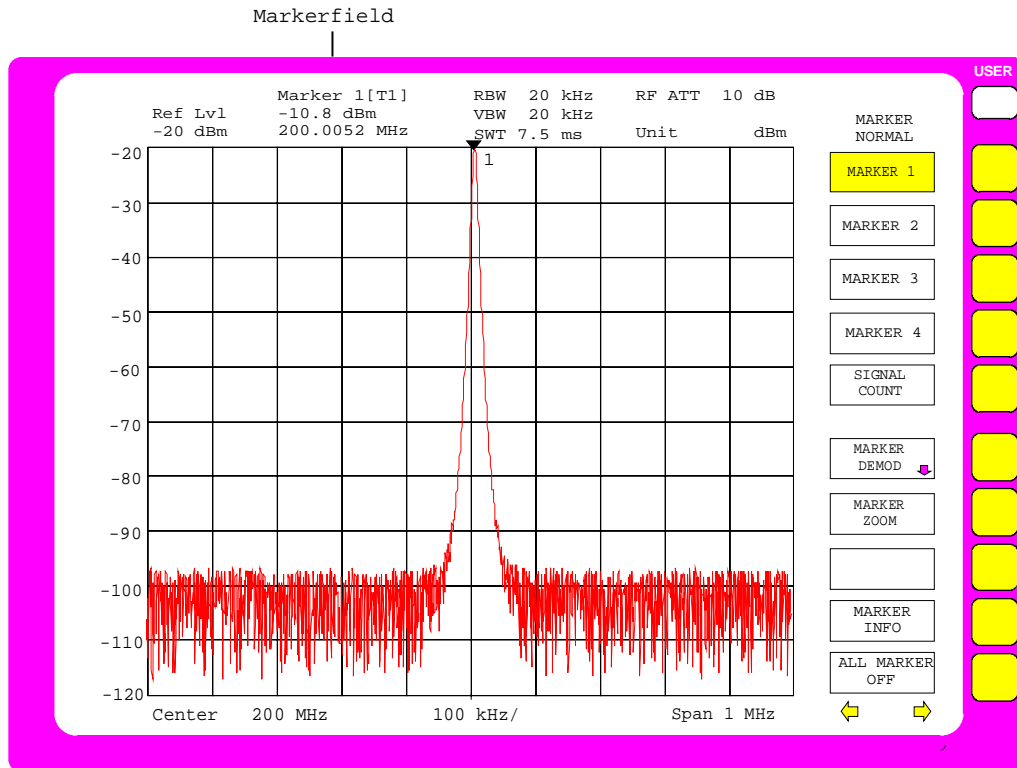
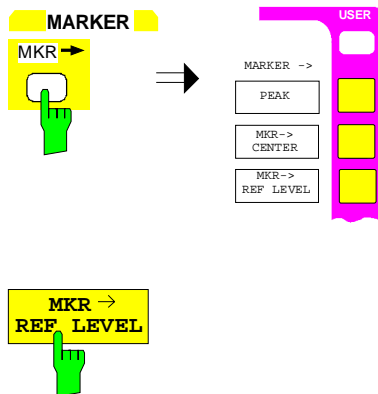

Fig. 2-1 200-MHz signal. The measured values are displayed in the marker field.

At low signal-to-noise ratios, the level measurement accuracy can be improved by an optimum selection of the FSE parameters. The accuracy of the frequency display can also be enhanced by applying the internal frequency counter.



6. Optimize the dynamic range and reduce the level measurement error.

- Press the *MKR*→ key in the *MARKER* key field. The *MARKER-MKR*→ menu is opened.

- Press *MKR* → *REF LEVEL* softkey.

The reference level (REF LEVEL) is reduced to the signal level.

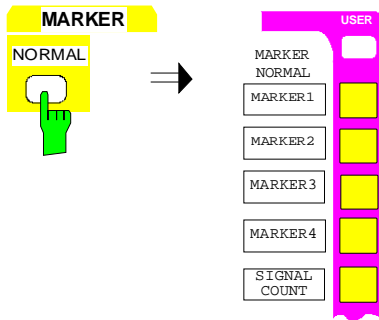

7: Determine the exact frequency with the internal frequency counter.

Note: The frequency counter measures the frequency of the marked signal with the selected counter resolution and at the accuracy of the internal frequency reference. A frequency measurement made using the marker is, however, limited by the number of horizontal display points and the applicable resolution bandwidth.

- Press the *NORMAL* key in the *MARKER* key field.
The *MARKER NORMAL* menu is opened.

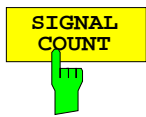

- Press the *SIGNAL COUNT* softkey.

The internal frequency counter is now active and measures the signal frequency with the *PRESET* resolution. The resolution is to be increased to 10 Hz.

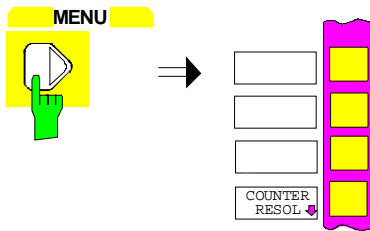

- Press the menu change key .
The supplementary menu is opened.

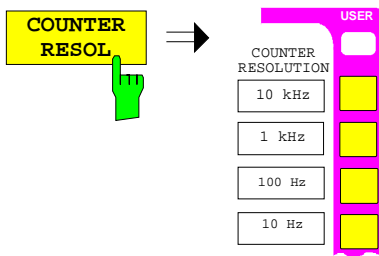

- Press the *COUNTER RESOL* softkey.
The *COUNTER RESOLUTION* sub-menu is opened.

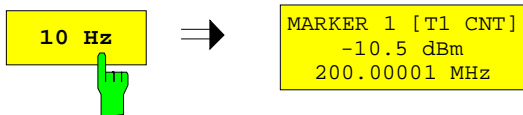

- Press the *10 Hz* softkey.
The desired frequency resolution (10 Hz) is now selected.
In the marker field, the item [CNT] indicates that the counter is active (see Fig. 2-2).

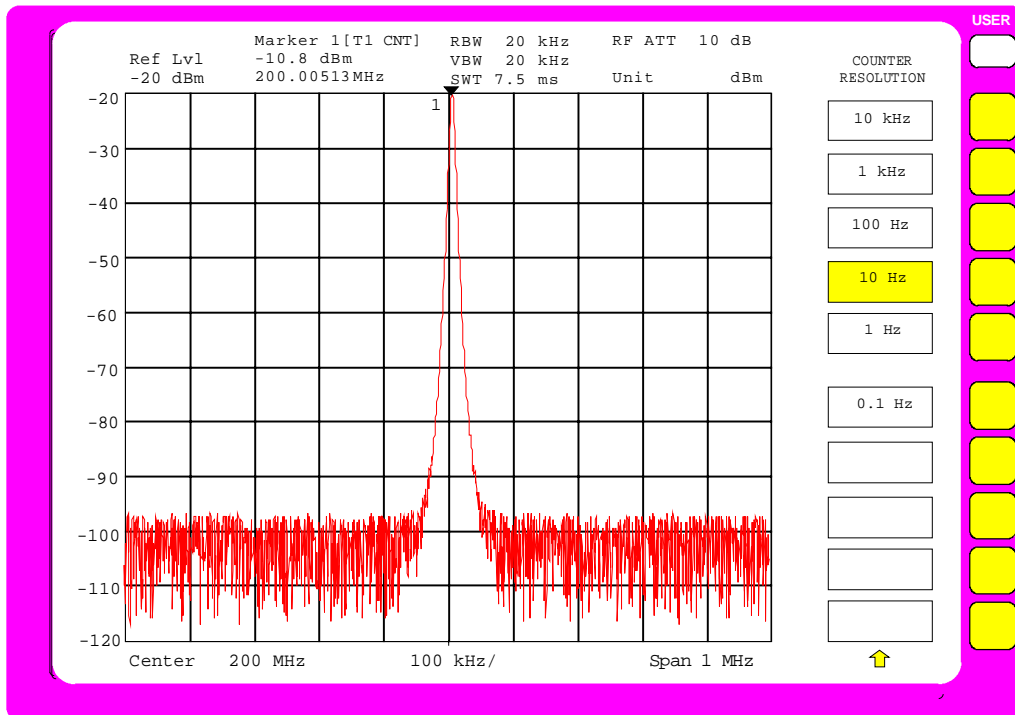

Fig. 2-2 Frequency measurement using the internal frequency counter.

Sweep, Level and Frequency Measurements – Example 2

The zoom function (*MARKER ZOOM*) operates much faster than the manual input of center frequency and measurement frequency range, and permits the measurement frequency range displayed on the screen to be as narrow as desired.

As in Example 1, a signal with a frequency of 200 MHz and a level of -10 dBm is applied to the analyzer RF INPUT.

The following setup steps are performed:

1. Reset the instrument.
2. Apply the signal.
3. Zoom in on the signal.
4. Measure the level and frequency with the marker.
5. Optimize the dynamic range and reduce the level measurement error.
6. Measure the frequency with the internal frequency counter.

Steps 1 to 2 and 4 to 6 correspond to steps 1 to 2 and 5 to 7, respectively, of Example 1. Step 3 replaces the manual input of center frequency and measurement frequency range. (steps 3 and 4).

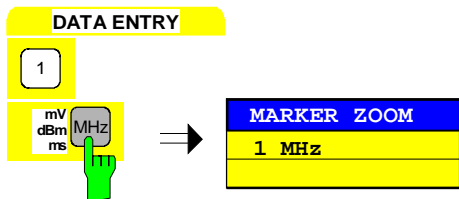
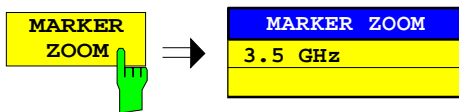
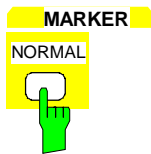

See steps 1 and 2 of example 1

1. **Reset the instrument to standard settings.**
2. **Connect the test signal to the analyzer RF INPUT.**

3. Zoom in on the signal.

- Press the *NORMAL* key in the *MARKER* key field .

The marker moves to the largest signal displayed on the screen. In this example, it is the signal at 200 MHz. (PEAK SEARCH function, see step 5 in Example 1).

- Press the *MARKER ZOOM* softkey.

The input field for the measurement frequency range appears on the display screen.

- Enter 1 via the numeric keypad and terminate with the *MHz* key.

After entry of the measurement frequency range, the marked signal is counted and then used as the new center frequency. At the same time, the entered measurement frequency range is set.

Note: In conjunction with the active measurement frequency range (SPAN) change, the resolution bandwidth (RES BW), video bandwidth (VIDEO BW) and sweep time (SWEEP TIME) are also set to new values since they are defined as coupled functions in the standard PRESET settings.

See steps 5 to 7 of example 1:

4. **Read the values for level and frequency as measured by the marker.**
5. **Optimize the dynamic range and reduce the level measurement error.**
6. **Determine the frequency with the internal frequency counter.**

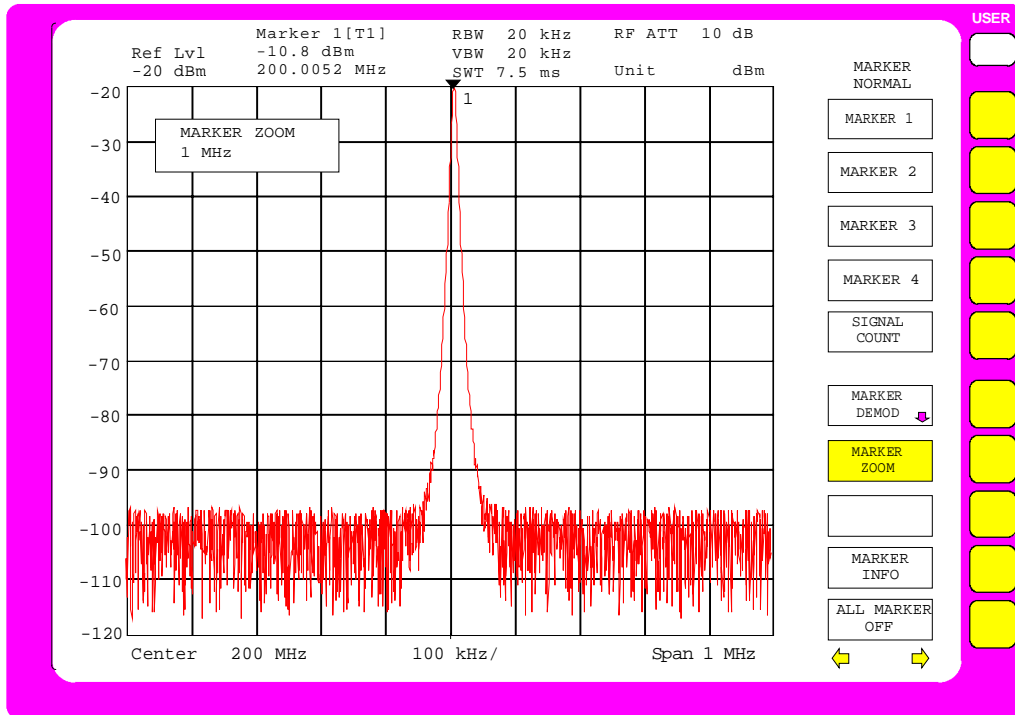

Fig. 2-3 The MARKER ZOOM function requires the entry of the measurement frequency range (span)

Level Measurement Accuracy

The level measurement accuracy of an analyzer is influenced by the following parameters:

- RF attenuator (*RF-ATT*)
- IF amplification
- Resolution bandwidth (*RES BW*)
- Display range (*LEVEL RANGE*)
- Display linearity (*SCALE FIDELITY*)

The error in a level measurement for the FSE is < 1 dB for frequencies up to 1 GHz and < 1.5 dB for frequencies from 1 GHz to 3.5 GHz. This specification includes all of the above mentioned influential factors. The frequency characteristics of the pertinent modules (RF divider, front end) are stored individually in memory on each module. The FSE initializing routines read out the corresponding values during execution immediately after the analyzer is turned on and corrects the frequency characteristics during the sweep. Any errors in the attenuation settings, the filter bandwidth or the video rectifier are corrected after calling the built-in calibration routines. For calibration purposes, the FSE has an internal 120 MHz calibration source which is switched internally to the RF INPUT.

The measurement accuracy is guaranteed only after running the calibration routines. It should be noted, however, that the individual parameters are so stable that a calibration need only be performed, after approximately 15 minutes warm-up time, for larger temperature variations. Normally, a weekly calibration is more than adequate.

Measurement of Harmonic Separation

Measurement Task

The measurement of signal harmonics is a frequently occurring task which can be optimally performed by a spectrum analyzer. In general, all signals will contain harmonics to some degree. Harmonics are especially critical in high-power transmitters, e.g., in radio transmitters, where a significant radiated harmonic component may interfere with the reception of other radio services. Generally, non-linear device characteristics create harmonics which are often selectively reduced through the use of low-pass filters. Since the spectrum analyzer also has non-linear characteristics, e.g., at the first mixer, it is necessary to exercise caution during a measurement to insure that the spurious harmonics generated by the analyzer do not influence the measurement results. If necessary, the fundamental frequency must be selectively attenuated with respect to the harmonics by insertion of an appropriate high-pass filter.

For harmonic-content measurements, the achievable measurement dynamic range is dependent upon the k2 intercept of the spectrum analyzer. The k2 intercept point is defined as the fictitious first-mixer input level where the levels of the first harmonic and of the fundamental frequency are equal. In practice, this level cannot be applied to the mixer since, to do so, would cause its destruction. However, using the k2 intercept point concept, the achievable measurement dynamic range for the harmonics of a Unit Under Test (UUT) can be calculated with relative simplicity.

As can be seen in Fig.2-4, the harmonic level is reduced by 20 dB when the level at the fundamental frequency is reduced by 10 dB.

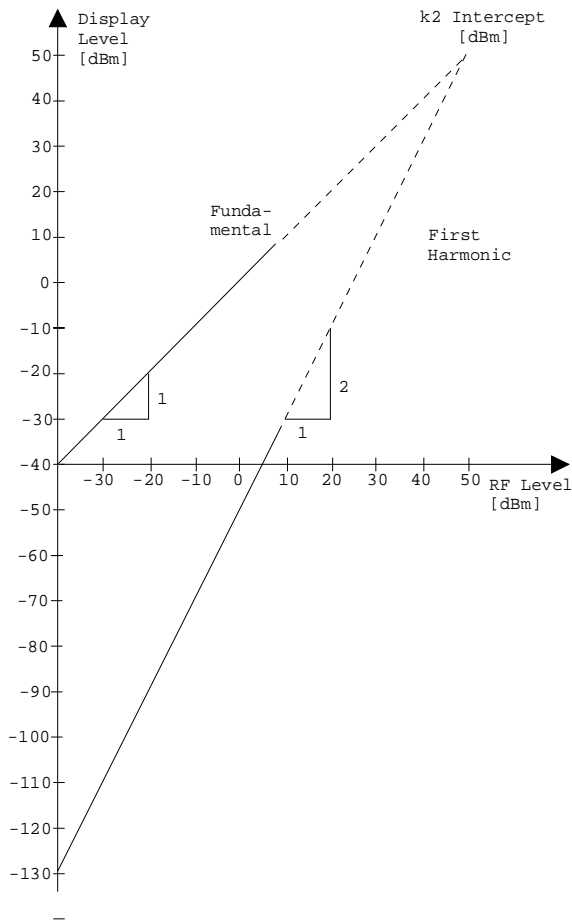

Fig.2-4 Theoretical display curve of fundamental and first harmonic with a k2 intercept of 50 dBm.

From the linear equations and the given intercept point, the following formula can be derived for the achievable harmonic separation a_{k2} in dB:

$$a_{k2} = IP2 - P_e \quad (1)$$

a_{k2} = harmonic separation
 P_e = mixer level/dBm
 $IP2$ = k2 intercept point

The formula for the internally produced level P_1 at the first harmonic in dBm is:

$$P_1 = 2 \cdot P_e - IP2 \quad (2)$$

The lower harmonic measurement limit is dictated by the noise figure of the spectrum analyzer. Through adequate averaging with the video filter, the UUT harmonic level which is to be measured should be at least 4 dB over the noise figure so that the measurement error caused by the input noise is less than 1 dB.

From the above, the following rules for the measurement of large harmonic separations can be derived:

- Select an IF bandwidth as narrow as possible in order to reduce the noise figure.
- Select the RF attenuation as high as required so that the necessary harmonic separation can still be measured.

Note: *The mixer amplitude is the applied RF level reduced by the selected RF attenuation. The low distortion (LOW DISTORTION function) mode of the analyzer automatically sets the optimum RF attenuation for the best harmonic separation.*

The maximum harmonic separation is achieved when the harmonics level is equal to the inherent noise level of the receiver. The corresponding level at the mixer according to (2) is:

$$P_e [dBm] = \frac{P_{noise} / dBm + IP2}{2}$$

For a 30 Hz resolution bandwidth, (noise level < -140 dB, $IP2 = 50$ dBm), this level is -45 dBm. Therefore, according to (1), the maximum measurable harmonic separation is 95 dB less 4 dB minimum signal-to-noise ratio.

Important Spectrum Analyzer Functions

In addition to frequency and level settings, the harmonic separation measurement requires, above all, the delta markers. Also, the MRK→CF STEP SIZE function (marker frequency = center frequency step-width) is used in order to quickly measure the individual harmonics with the cursor keys.

There are several methods to measure harmonic content:

- The measurement of fundamental and harmonic signals in one measurement frequency range.
- The individual measurement of the harmonic separation in a narrow measurement frequency range. This method is preferred when high harmonic separation is to be measured (requires large dynamic range and, thus, narrow resolution bandwidth) or the frequency of the fundamental is very high, i.e., a very wide measurement frequency range is necessary.
- The measurement of fundamental and harmonics in two independent windows on the display screen (SPLIT SCREEN mode).

Example 1 describes the measurement of fundamental and harmonics in one measurement frequency range.

Example 2 describes the measurement of harmonic separation in separate measurement frequency ranges.

Example 3 shows the measurement of fundamental and harmonics in two independent windows on the display screen.

Measurement Procedure - Harmonic Separation – Example 1

The analyzer 10 MHz reference signal is used at the input signal. The connector EXT REF IN/OUT on the rear panel is connected to the analyzer front-panel RF INPUT. Since the output level is 7 dBm, the reference level must be set to 10 dBm.

The following setup steps are performed:

1. Reset the instrument.
2. Set the reference level to 10 dBm.
3. Connect the rear-panel 10 MHz reference signal to the analyzer input RF INPUT.
4. Set the start frequency to 5 MHz.
5. Set the stop frequency to 55 MHz.
6. Smooth the displayed noise with the video bandwidth.
7. Measure the fundamental signal with the marker.
8. Measure the harmonic separation with the delta marker.
9. Measure the separation of remaining harmonics.

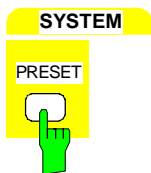

1. Reset the analyzer.

- Press the *PRESET* key.

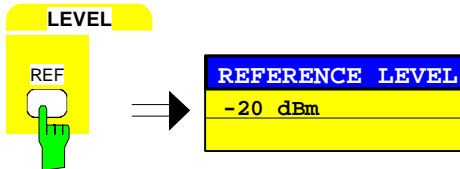

2. Set the reference level to 10 dBm.

- Press *REF* key in the *LEVEL* key field.

The entry field for the reference level appears on the display screen.

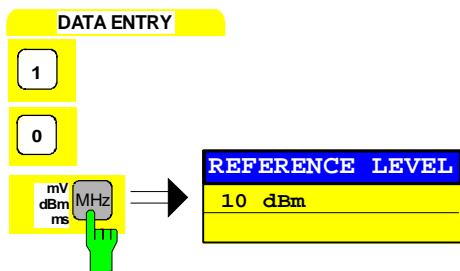

- Enter 10 via the numeric keypad and terminate with the *dBm* key.

3. Connect the 10 MHz-reference signal (output EXT REF IN/OUT) to the analyzer RF INPUT.

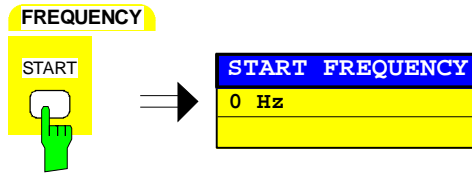

4. Set the start frequency to 5 MHz

- Press the *START* key in the *FREQUENCY* key field. The entry window for the start frequency appears on the display screen.

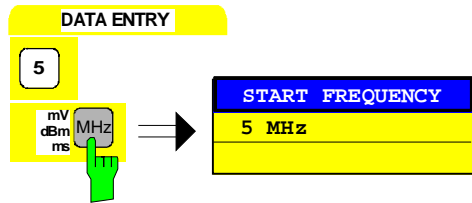

- Enter 5 via the numeric keypad and terminate with the *MHz* key.

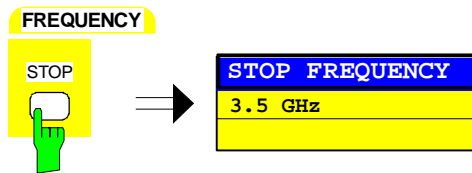

5. Set the stop frequency to 55 MHz

- Press the *STOP* key in the *FREQUENCY* key field. The entry window for the stop frequency appears on the display screen.

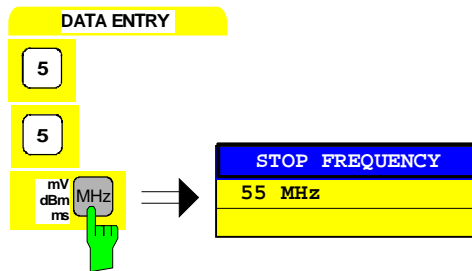

- Enter 55 via the numeric keypad and terminate with the *MHz* key.

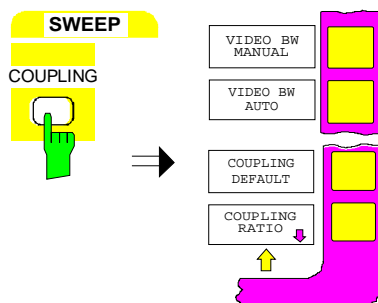

6. Smooth the displayed noise with the video bandwidth

- Press the *COUPLING* key in the *SWEEP* key field.

The *SWEEP-COUPLING* menu is opened.

The video bandwidth can now be either automatically coupled to the resolution bandwidth or manually entered.

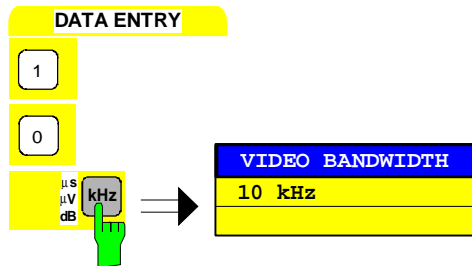
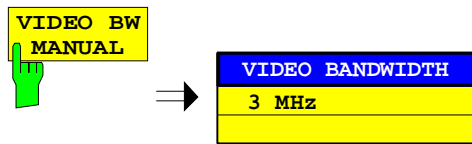
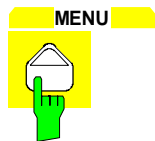
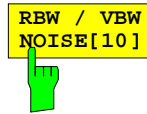
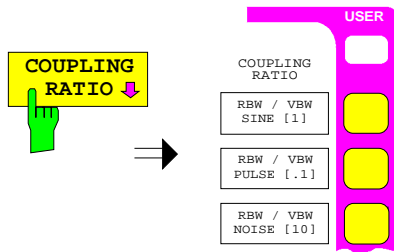

either:

Automatic coupling of the video bandwidth to the measurement frequency range

- Press the *COUPLING RATIO* softkey.

The sub-menu for setting the automatic coupling of bandwidths to the measurement frequency range is opened.

- Press the *RBW / VBW NOISE [10]*.

The video bandwidth is set to a factor of 10 less than the resolution bandwidth. This smoothes the displayed noise.

- Press the menu change key .

The *COUPLING RATIO* submenu is closed.

or:

Manual input of the video bandwidth

- Press the *VIDEO BW MANUAL* softkey.

The entry field for the video bandwidth appears on the display screen.

- Enter 10 via the numeric keypad and terminate with the *kHz* key.

The analyzer displays the fundamental as well as the first to third harmonics (see Fig.2-5).

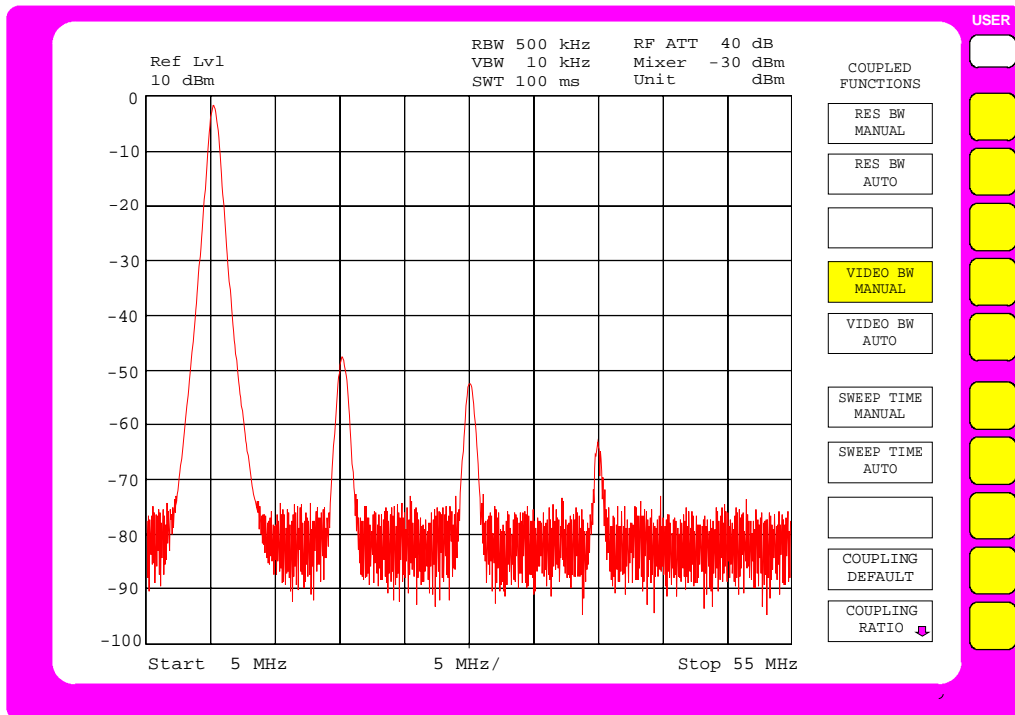

Fig.2-5 The fundamental and harmonics to 55 MHz



7. Measure the fundamental with the marker.

- Press the *NORMAL* key in *MARKER* key field.

The marker appears at the fundamental peak (see also level and frequency measurement step 5 of the *PEAK SEARCH* function).

The measured values can be read at the upper left of the display screen.



8: Activate the delta marker and measure the harmonic separation

- Press the *DELTA* key in the *MARKER* key field

The delta marker is active and appears on the fundamental.

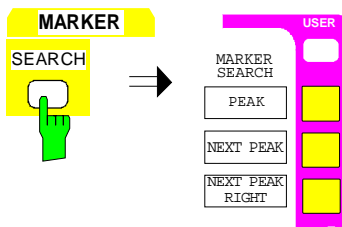

- Press the *SEARCH* key in the *MARKER* key group .

The *SEARCH-MARKER* menu is opened.



- Press the *NEXT PEAK RIGHT* softkey.

The delta marker jumps to the first harmonic and measures the difference between the harmonic and the fundamental. The measured values can be read at the upper left of the display screen. In this example, the harmonic separation is approx. 40 dB (see Fig.2-6).



9. Measure the separation of additional harmonics

- Press the *NEXT PEAK RIGHT* softkey.

The delta marker jumps to the next highest harmonic. The measured value can be read as before.

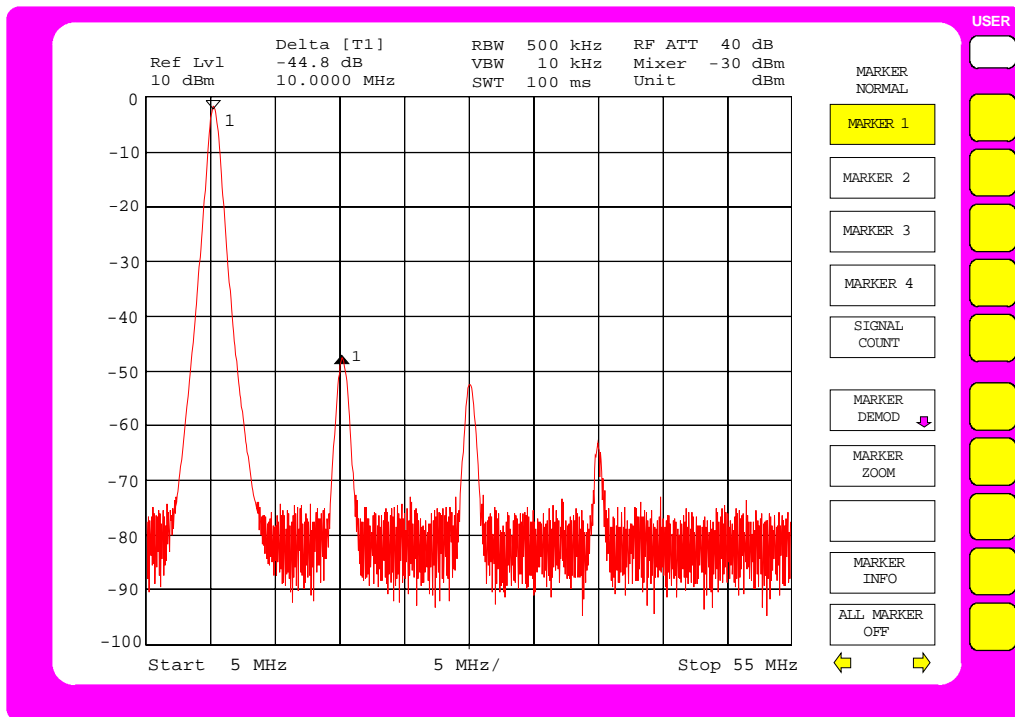

Fig.2-6 First harmonic separation: approx. 40 dB referred to the fundamental

Measurement Procedure - Harmonic Separation – Example 2

In example 2, the fundamental frequency of the test signal and the separation of the individual harmonics are measured. The reference to the fundamental is established with the REFERENCE FIXED marker, and the movement from harmonic to harmonic is performed with the MKR→ CF STEP SIZE and step keys. This method is recommended when the highest dynamic range is to be achieved.

The following measurement steps are carried out:

1. Reset the instrument.
2. Set the reference level to 10 dBm.
3. Connect the rear-panel 10 MHz reference signal (connector EXT REF IN/OUT) to the analyzer input RF INPUT.
4. Set the start frequency to 5 MHz.
5. Set the stop frequency to 55 MHz.
6. Smooth the displayed noise with the video bandwidth.
7. Measure the fundamental signal with the marker.
8. Reduce the measurement frequency range (ZOOM function):
9. Set the frequency step size to the fundamental frequency.
10. Save the reference value (REFERENCE FIXED)
11. Measure the separation to the first harmonic.
12. Measure the separations to the remaining harmonics.

Set the analyzer according to Example 1 up to and including "Measure the fundamental with the marker" (steps 1 to 7).

8. Reduce the measurement frequency range.

- Press the *NORMAL* key in the *MARKER* key field .
The *MARKER-NORMAL* menu is opened.

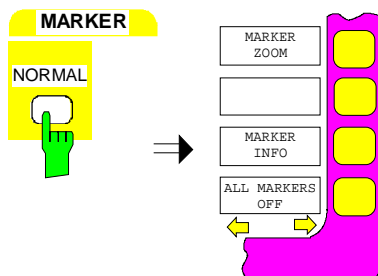

- Press the *MARKER ZOOM* softkey.

The entry field for the measurement frequency range appears on the display screen.

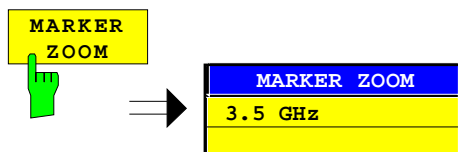

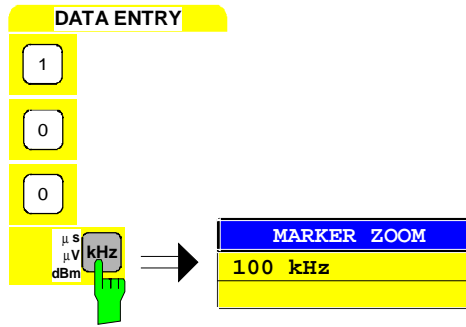

➤ Enter 100 via the numeric keypad and terminate with the kHz key.

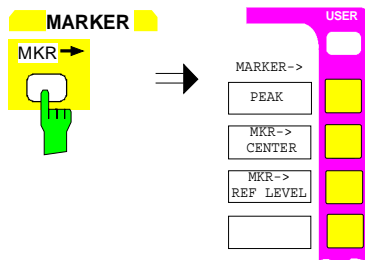

9. Set the frequency step size to the fundamental frequency

➤ Press the MKR → key in the MARKER key field
The MARKER-MKR → menu is opened.

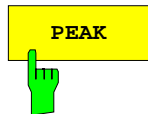

➤ Press the PEAK softkey.

The marker appears at peak of the fundamental signal.

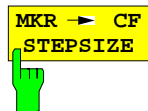

➤ Press the MKR → CF STEP SIZE softkey.

The step size used when setting the center frequency with the cursor keys is set equal to the marker frequency.

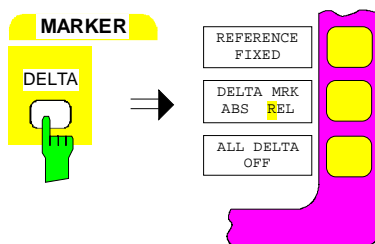

10. Fix reference value

➤ Press the DELTA key in the MARKER key field.
The DELTA-MARKER menu is opened.

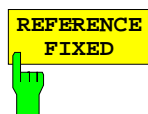

➤ Press the REFERENCE FIXED softkey.

The position of the marker is now a curve-independent reference for the delta measurement, even when the actual reference point is not visible on the display screen.

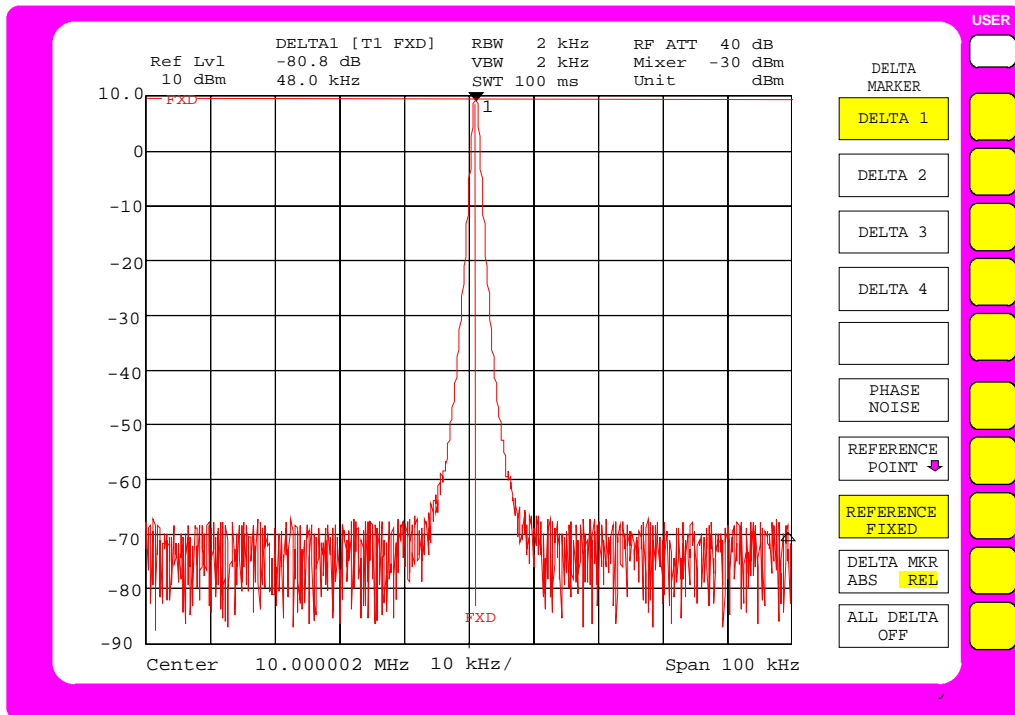
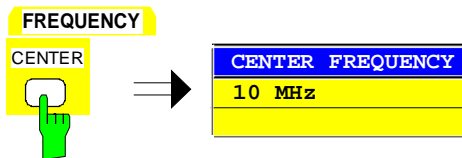

Fig. 2-7 Fundamental with REFERENCE FIXED marker



11. Measure the harmonic

- Press the *CENTER* key in the *FREQUENCY* key field.

The entry field for the center frequency appears on the display screen.

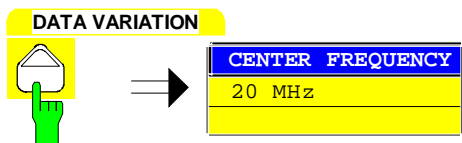

- Press the cursor key  in the *DATA VARIATION* key field.

The center frequency is increased by one step (= fundamental frequency).

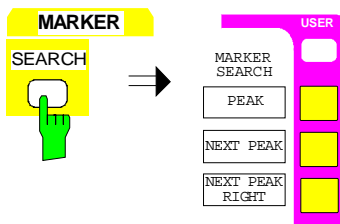

- Press the *SEARCH* key in the *MARKER* key field.

The *SEARCH-MARKER* menu is opened.

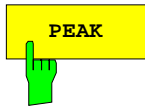

- Press the *PEAK* softkey.

The delta marker appears at the first harmonic and measures the separation from harmonic to fundamental. The measured value is displayed in the marker field at the upper left of the display screen (see Fig. 2-8).

12. Measure the separation of additional harmonics

- Repeat all of step 11.

The center frequency is once again increased by the frequency of the fundamental. The delta marker thus appears at the next harmonic.

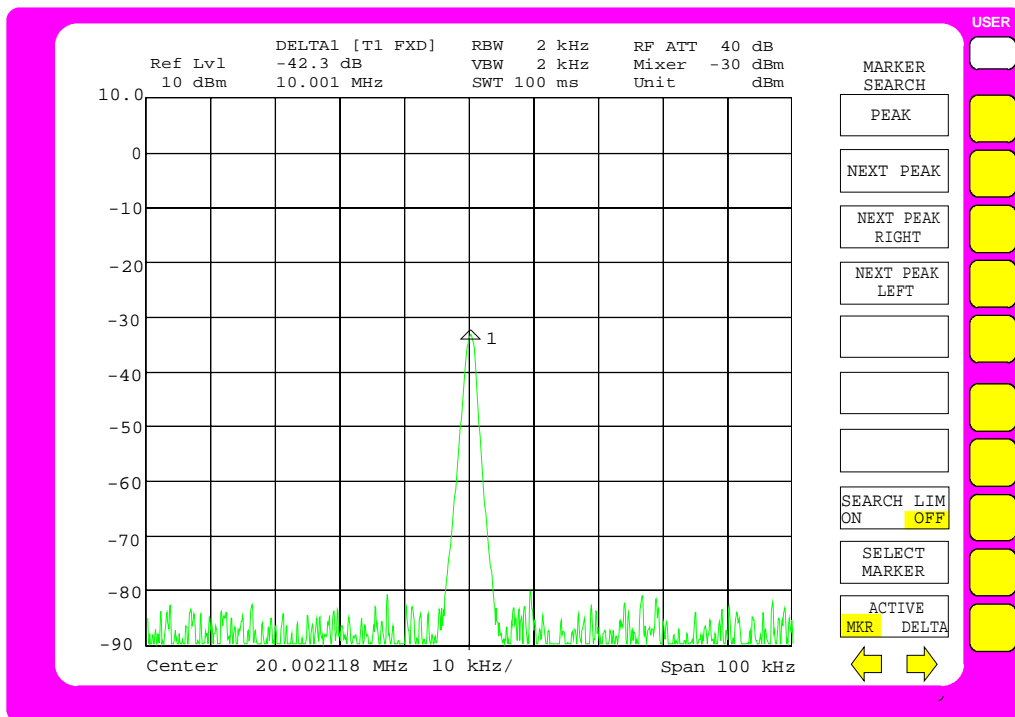

Fig. 2-8 Measurement of the first harmonic

Note: The spurious harmonics generated internal to the analyzer can be easily recognised by switching in additional RF attenuation. When an additional 10 dB attenuation is inserted, the displayed level of harmonics generated by the analyzer will be reduced by 10 dB, however, harmonics from the UUT will remain unchanged. This assumes that the receiver noise is substantially below the displayed level.

Measurement Procedure - Harmonic Separation – Example 3

The measurement of fundamental and harmonics can also be performed in two independent windows on the display screen (SPLIT-SCREEN mode). This mode permits the simultaneous presentation of the fundamental and harmonics with higher resolution and dynamic range.

The following measurement steps are carried out:

1. Reset the instrument.
2. Set the reference level to 10 dBm.
3. Connect the rear-panel 10 MHz reference signal (connector EXT REF IN/OUT) to the analyzer input RF INPUT.
4. Set the start frequency to 5 MHz.
5. Set the stop frequency to 55 MHz.
6. Smooth the displayed noise with the video bandwidth.
7. Measure the fundamental signal with the marker.
8. Reduce the measurement frequency range (ZOOM function):
9. Set the frequency step size to the fundamental frequency.
10. Set the display to two measurement windows.
11. Uncouple the window settings.
12. Measure the harmonic separation.

Set the analyzer according to Example 2 up to and including " Set the frequency step size to the fundamental frequency" (steps 1 to 9).

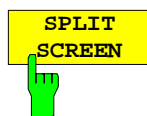
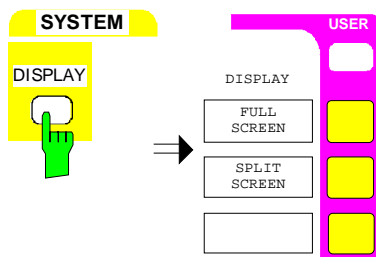

10. Set the display to two uncoupled measurement windows.

- Press the *DISPLAY* key in the *SYSTEM* key field.
The *SYSTEM DISPLAY* menu is opened.

- Press the *SPLIT SCREEN* softkey.

Two windows are displayed simultaneously on the display screen (see Fig.2-9). The upper measurement window is called Screen A and the lower is called Screen B. At the initial turn-on, both measurement windows are coupled, i.e., changes in settings such as frequency or levels take place in both windows.

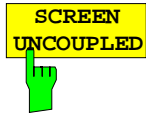
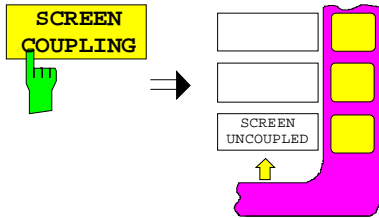

11. Uncouple the window settings

- Press the *SCREEN COUPLING* softkey.
The *SCREEN COUPLING* sub-menu is opened.

- Press the *SCREEN UNCOUPLED* softkey .

The settings for each measurement window can now be selected independently. The entry is assigned to either *ACTIVE SCREEN A* or *ACTIVE SCREEN B* as selected by the softkey in the main menu window.

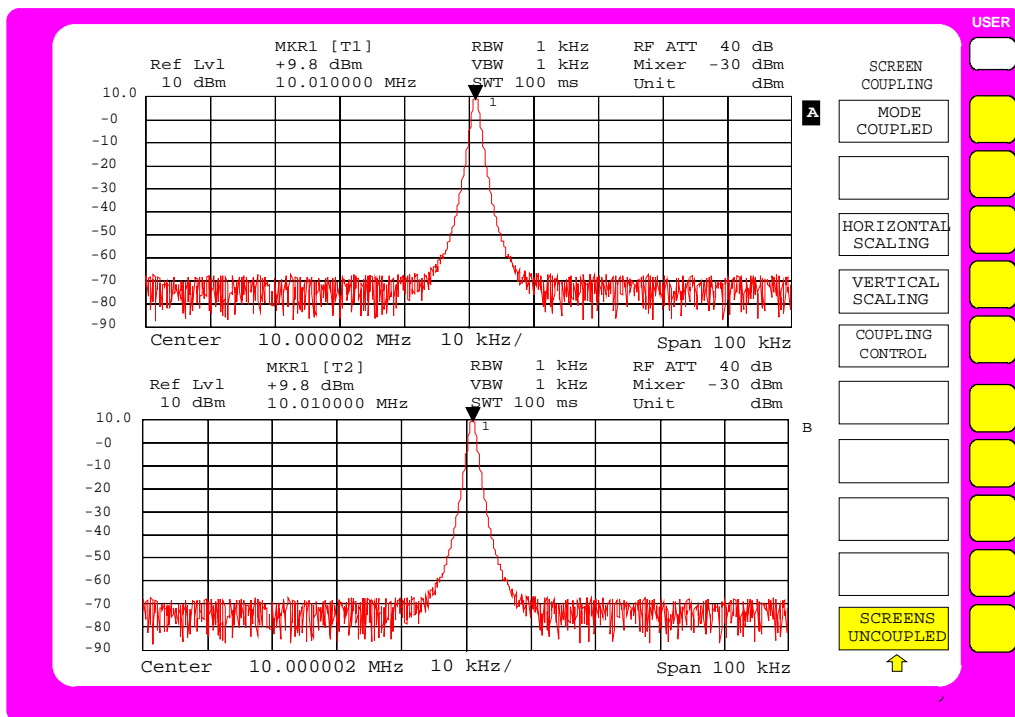
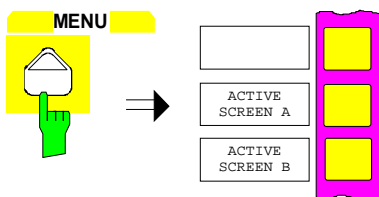



Fig.2-9 SPLIT-SCREEN Mode



12. Measure the harmonic in the lower measurement window SCREEN B.

- Press the menu change key  .
The main menu is opened.



- Press the *ACTIVE SCREEN B* softkey.

The following entries are now valid for the lower window which is used to measure the harmonic separation.

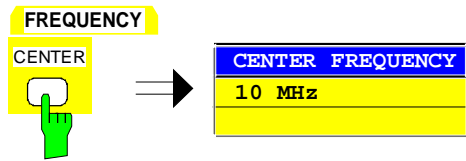

- Press the *CENTER* key in the *FREQUENCY* key field.

The entry field for the center frequency appears on the display screen.

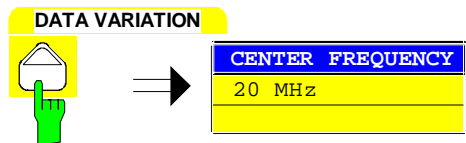

- Press the cursor key  in the *DATA VARIATION* key field.

The center frequency is increased by one step. (= fundamental frequency).

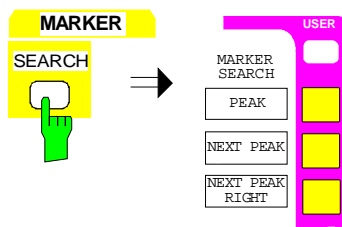

- Press the *SEARCH* key in the *MARKER* key field.

The *SEARCH-MARKER* menu is opened.

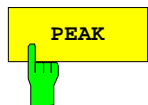

- Press the *PEAK* softkey.

A marker appears at the first harmonic and measures the level of the harmonic. The measured value is displayed in the marker field at the upper left of the second measurement window (see Fig.2-10).

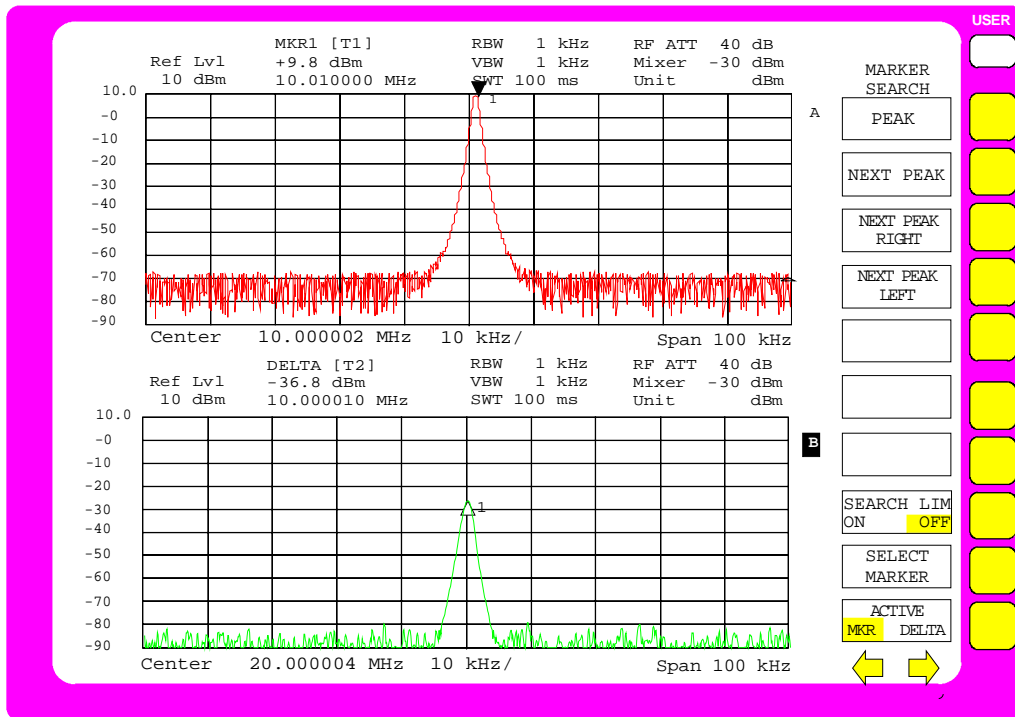

Fig.2-10 Alternate representation of fundamental and first harmonic

Measurement of Intermodulation Distortions

Measuring Task

If several signals are applied to a transmission quadripole with a non-linear characteristic, intermodulation products occur at its output due to addition and subtraction of the signals. The non-linear characteristic causes harmonics of the information signals to occur, which are mixed up at the characteristic. The low-order mixture products are particularly significant since they have the highest levels and are close to the information signals. The third-order intermodulation product causes the most significant distortions. In case of two-tone modulation it is the mixture product of the first information signal and the first harmonic of the second information signal.

The frequencies of the spurious signals occur with an offset of the information signals above and below the information signals. Fig. 2-11 shows the intermodulation products P_{S1} and P_{S2} , which are obtained from the two information signals P_{N1} and P_{N2} .

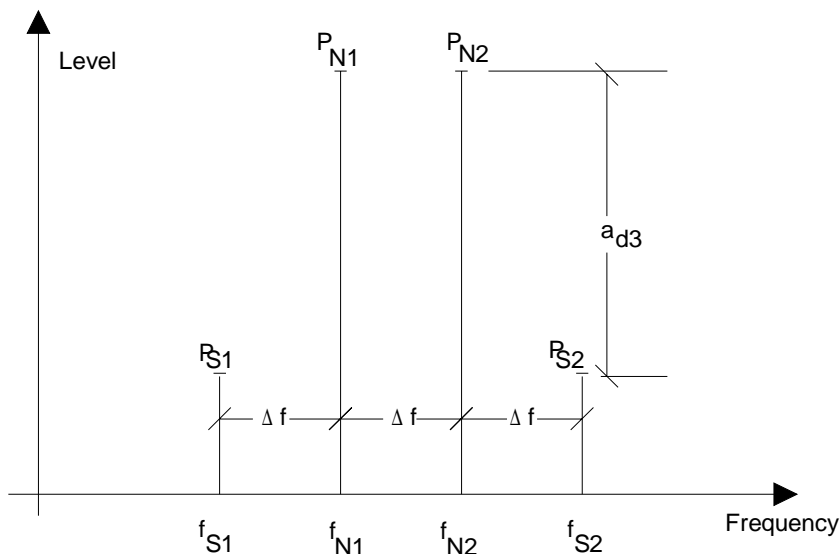

Fig. 2-11 Intermodulation products P_{S1} and P_{S2}

The intermodulation product at f_{S2} is obtained by mixture of the first harmonic of the information signal P_{N2} with the signal P_{N1} , the intermodulation product at f_{S1} by mixture of the first harmonic of the information signal P_{N1} with the signal P_{N2} .

$$f_{s1} = 2 \times f_{n1} - f_{n2} \quad (1)$$

$$f_{s2} = 2 \times f_{n2} - f_{n1} \quad (2)$$

The level of the spurious products depends on the level of the information signals. If both information signals are increased by 1 dB, the level of the spurious responses increases by 3 dB. I.e., the offset a_{d3} of the spurious responses decreases by 2 dB. This is illustrated by Fig.2-12.

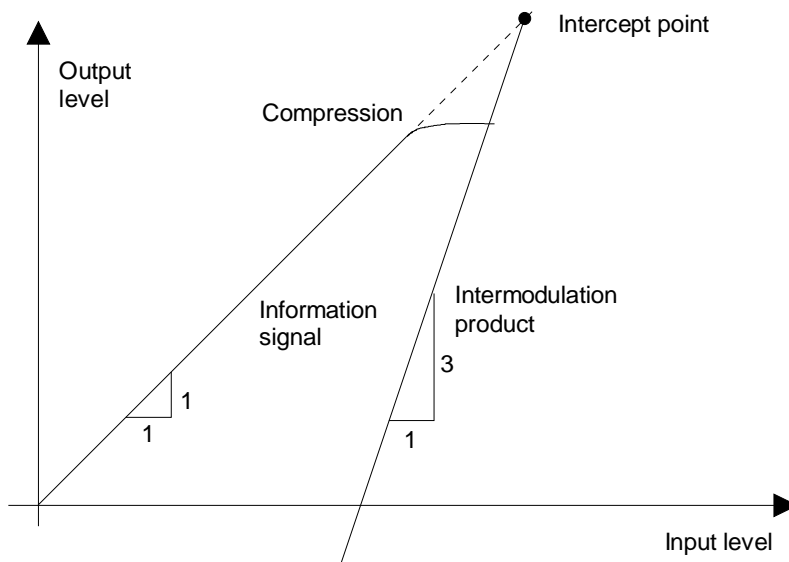

Fig.2-12 Dependence of the spurious product level from the level of the information signals

The information signals at the output of a four-terminal network increase as the input level increases as long as the input level is in the linear range. If the level changes by 1 dB at the input, it also changes by 1 dB at the output. At a specified input level the quadripole compresses and the output level does not increase any more. The third-order intermodulation products increase three times as fast as the information signals. The intercept point is the fictitious level where both lines intersect. It cannot be measured directly since the wanted level is limited by the maximum output power of the quadripole. It can however be calculated from the known gradients of the lines and the measured intermodulation offset a_{D3} with a given level using the following formula:

$$IP3 = \frac{a_{D3}}{2} + P_N \quad (3)$$

If, e.g., the intermodulation offset is 60 dB and the input level P_N is -20 dBm, the third-order intercept $IP3$ is calculated as follows:

$$IP3 = \frac{60}{2} + (-20 \text{ dBm}) = 10 \text{ dBm}. \quad (4)$$

Important Spectrum-Analyzer Functions

Correct setting of the RF attenuation is particularly important for intermodulation measurements. In the **FSE**, the attenuation can be set automatically according to the reference level. There are three coupling methods:

- RF ATTEN AUTO
- ATTEN AUTO LOW DIST
- ATTEN AUTO LOW NOISE

The coupling mode ATTEN AUTO LOW DIST is recommended to be used for measurement of intermodulation distortions since the intrinsic spurious products are minimized.

Measurement

In the following, measurement of the third-order intercept of an amplifier is described, by way of example.

Two signal generators with the frequencies f_1 and f_2 supply signals to the amplifier via a power divider. The output of the device under test is connected to the RF input of the **FSE**. The level of the two signal generators is the same and is selected such that the DUT is not overloaded.

$f_1 = 99.5$ MHz

$f_2 = 100.5$ MHz

Level at amplifier input = -20 dBm with f_1 and f_2

Test setup:

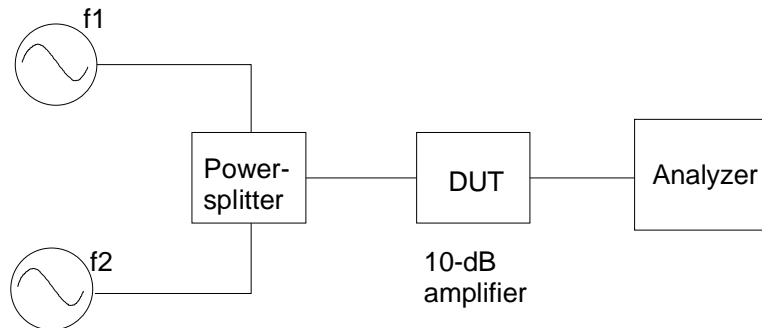

The following measurement steps are carried out:

1. Reset the **FSE**.
2. Set the center frequency to 100 MHz.
3. Set the frequency-display range to 5 MHz (SPAN function).
4. Set the reference level to -10 dBm.
5. Set the resolution bandwidth to 10 kHz.
6. Set the RF attenuation for low-distortion mode.
7. Measure the intercept point using the markers.
8. Calculate IP3 from the measured offset and the signal level according to (4)

Cf. measurement example Level and Frequency Measurements (steps 1 to 3)

1. *Reset the instrument.*
2. *Set the center frequency to 100 MHz.*
3. *Set the frequency-display range to 5 MHz.*

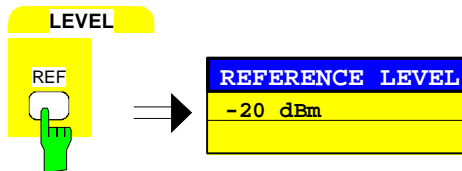

4. Set the reference level to -10 dBm

- Press the *REF* key in the *LEVEL* key field.

The entry window for the reference level is displayed.

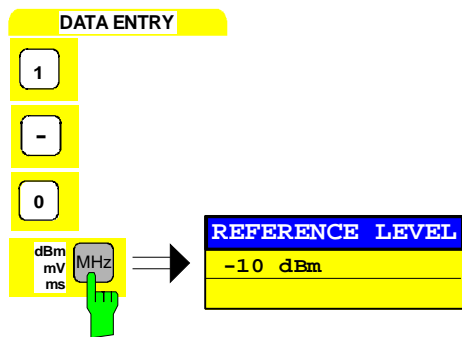

- Enter -10 via the numeric keypad in the entry field and terminate the entry by pressing the *dBm* key.

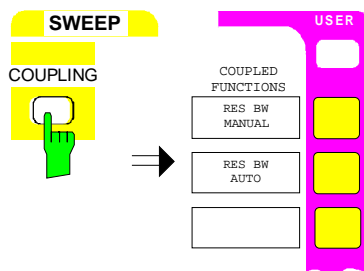

5. Set the resolution bandwidth to 10 kHz

- Press the *COUPLING* key in the *SWEEP* key field.

The *SWEEP-COUPLING* menu is opened.

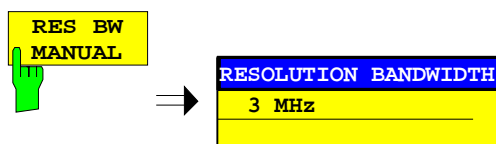

- Press the *RES BW MANUAL* softkey.

The entry field for the resolution bandwidth is displayed.

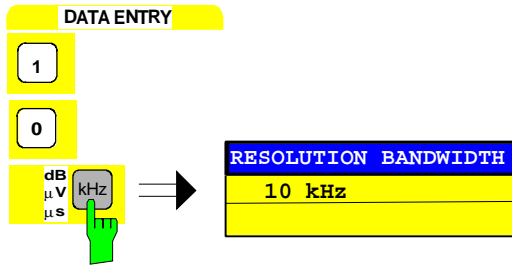

- Enter 10 in the entry field via the numeric keypad and terminate the entry by pressing the kHz key.

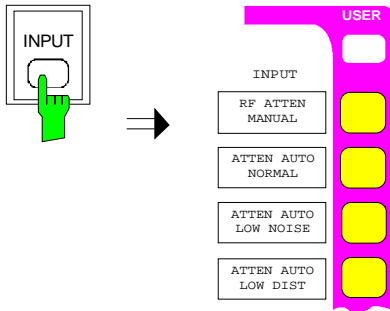

6. Set low-distortion mode

- Press the *INPUT* key
The *INPUT* menu is opened.

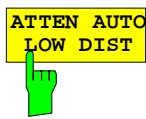

either

- Press the *ATTEN AUTO LOW DIST* softkey.
The low-distortion mode is selected. Thus, the combination of input attenuation and IF gain is selected such that the internal intermodulation products are the smallest possible and the intermodulation-free range is as large as possible.

The FSE shows the measuring diagram in Fig.2-13

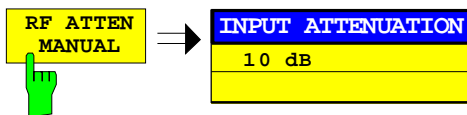

or

- Press the *RF ATTEN MANUAL* softkey.
The entry window for the RF attenuation is displayed.

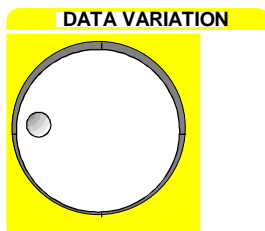

- Vary the RF attenuation using the roll-key.
If the amplitude of the IM products doesn't change, the existing setting is sufficient (see Fig.2-13)

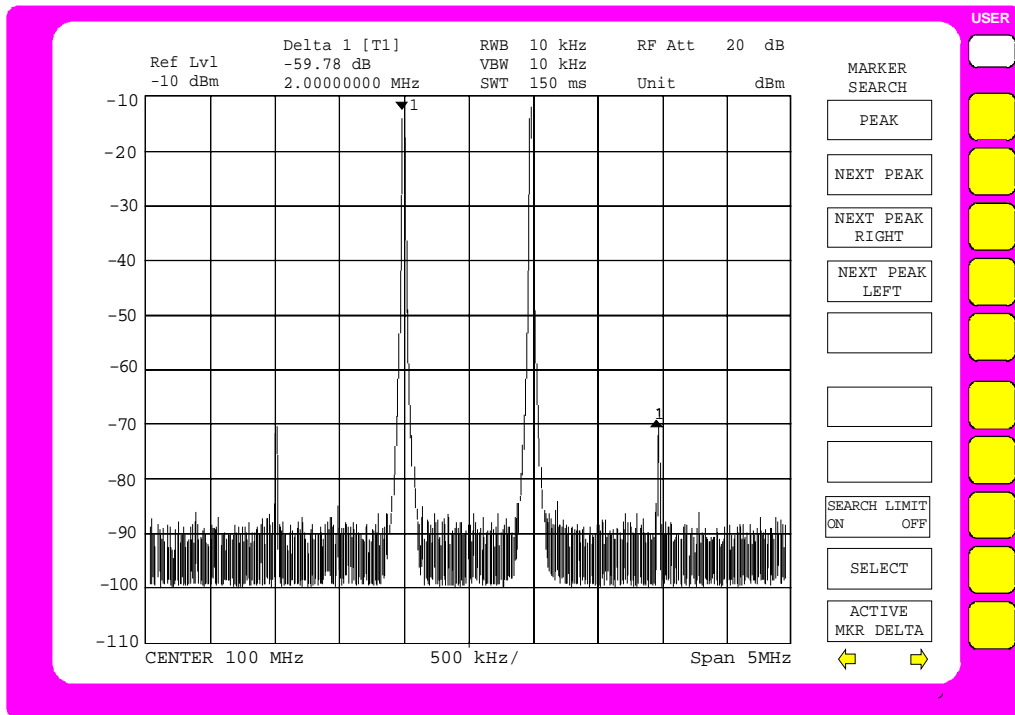

Fig.2-13 Measuring diagram in low distortion mode



7. Measure the intercept point using the markers

- Press the *NORMAL* key in the *MARKER* key field.

The marker appears on the fundamental (see also level and frequency measurement step 5, PEAK SEARCH function).

The measured values can be read off at the upper left of screen.



- Press the *DELTA* key in the *MARKER* key field.

The delta marker is active. It appears on the fundamental.

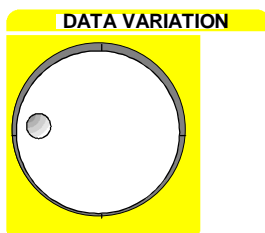

either

- Move the marker to an intermodulation product using the roll-key (see Fig.2-13).

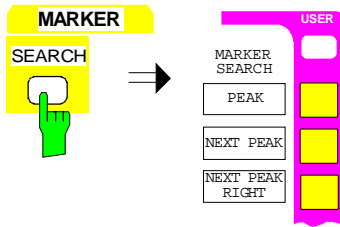

or

- Press the *SEARCH* key of the *MARKER* keys.
The *SEARCH-MARKER* menu is opened.

-
- Press the *NEXT PEAK RIGHT* softkey until the delta marker appears on one of the IM products (see Fig.2-13).

8. Calculate IP3 from the measured offset and the signal level according to (4)

In the example, an intermodulation ratio of approx. 60 dB at a level of -10 dBm was measured. IP3 is thus:

$$IP3 = 60 \text{ dB}/2 + (-10\text{dBm}) = 20 \text{ dBm}$$

Time-domain Measurements with Pulsed Signals

Measuring Task

A lot of systems which handle pulsed signals do not only require measurement of the pulse width and the pulse repetition rate which can be derived from the spectrum but also assess the rise and fall time as well as the power ramping during the pulse. In particular, modern digital mobile radio systems which, like GSM e.g., employ the TDMA method, require the power to be measured versus time over a wide dynamic range.

Time-domain measurements are performed using the spectrum analyzer with ZERO SPAN selected. The analyzer operates as fix-tuned receiver on the set center frequency such that the signal power versus time is displayed.

Important Spectrum Analyzer Functions

Trigger functions such as video trigger and sweep settings such as blanking of the measured value (GAP SWEEP) are of particular importance for time-domain measurements. The pretrigger function of the GAP SWEEP just enables measurement of rise times since it allows for representation of measurements prior to the trigger point. The GAP function, which enables cutout of a part of the pulse signal on the screen at high time resolution. During the GAP time, the sweep and thus data acquisition at the time marked by the "GAP" line is interrupted and thus the pulse is not completely displayed (the part which is not important for this measurement is blanked) (see Fig. 2-14).

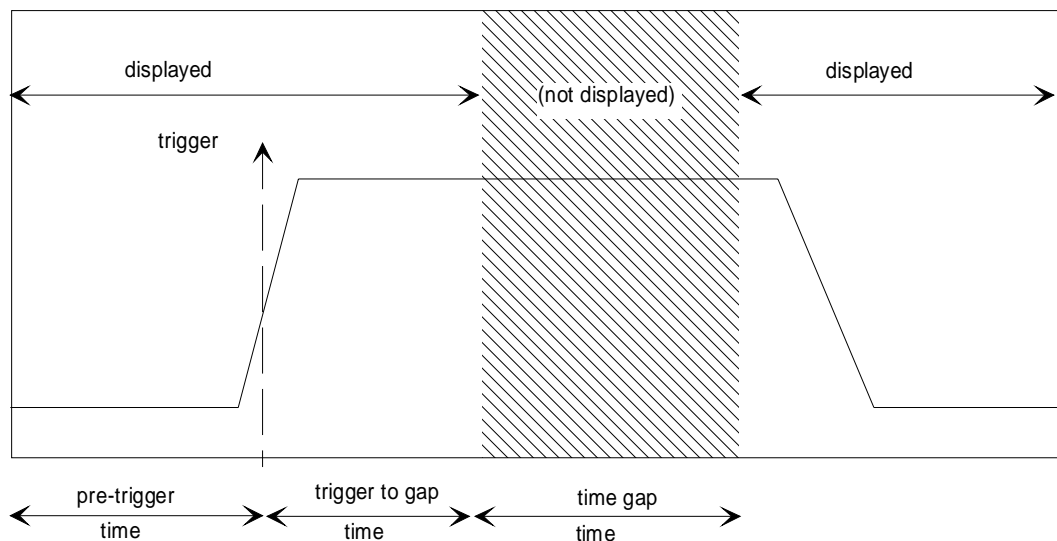

Fig. 2-14 Parameters of Gap Sweep

Note: If the pretrigger time and the trg-to-gap time is 0 s, the gap time function has the same effect as a delayed trigger.

Measurement

This example shows the measurement of the rise and fall times as well as the power ramping during the pulse.

The signal generator SME with built-in pulse modulation source SME-B4 is used as signal source. A signal generator providing for pulse modulation in conjunction with an external pulse generator may be used, instead.

Settings on the signal generator:

| | |
|-----------------|-----------------|
| Frequency | 900 MHz |
| Level | -5 dBm |
| Modulation | Pulse |
| Pulse width | ca. 600 μ s |
| Pulse frequency | ca. 500 Hz |

The following measuring steps are made:

1. Reset the instrument.
The video bandwidth is thus set to 3 MHz.
2. Set the center frequency to 900 MHz.
3. Set the frequency display range to zero span.
4. Set the reference level to 0 dBm.
5. Set the resolution bandwidth to 2 MHz.
6. Set the sweep time to 1 ms.
7. Connect the RF output of the SME to the RF input of the **FSE**.
8. Set the video trigger.
9. Set the sweep time to 100 μ s.
10. Set the trigger points.
11. Activate the gap sweep.

comp. measuring example - level and frequency measurement (steps 1 to 3)

- 1. Set the instrument to the default state. I.e., the video bandwidth is set to 3 MHz.***
- 2. Set the center frequency to 900 MHz.***
- 3. Set the frequency-display range to zero span.***

Note: *With first calling of the zero span following preset, a resolution bandwidth of 1 MHz is automatically set. Apart from that, switching on the zero span always causes that resolution bandwidth to be set that was last set in zero span.*

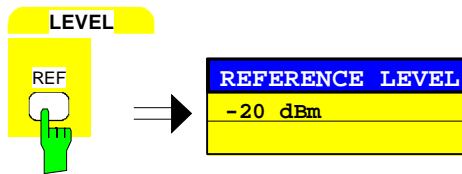

4. Set the reference level to 0 dBm.

- Press the *REF* key in the *LEVEL* key field.
The entry field for the reference level appears on the display screen.

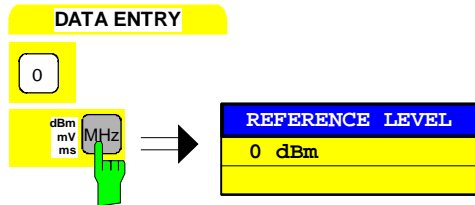

- Enter *0* in the entry field via the numeric keypad and terminate the entry by pressing the *MHz/ms* key.

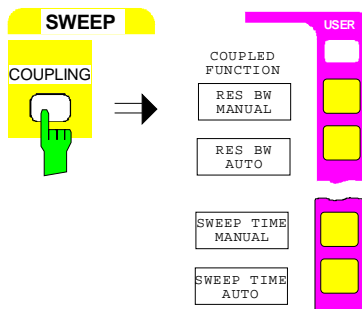

5. Set the resolution bandwidth to 2 MHz

- Press the *COUPLING* key in the *SWEEP* key field.
The *SWEEP-COUPLING* menu is opened.

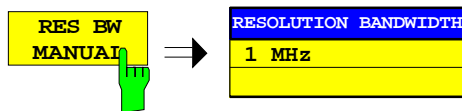

- Press the *RES BW MANUAL* softkey.
The entry field for the resolution bandwidth appears on the display screen.

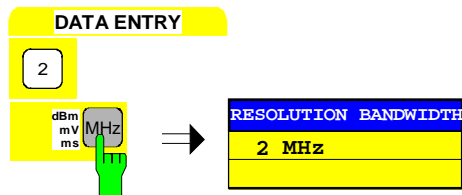

- Enter *2* via the numeric key pad and terminate the entry by pressing the *MHz* key.

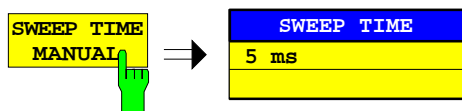

6. Set the sweep time to 1 ms

- Press the *SWEEP TIME MANUAL* softkey.
The entry field for the sweep time is opened.

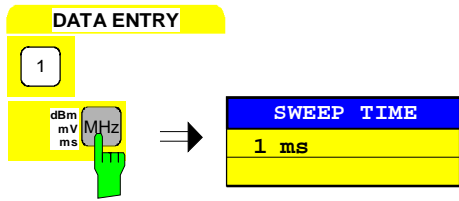

- Enter 1 in the entry field via the numeric keypad and terminate the entry by pressing the MHz key.

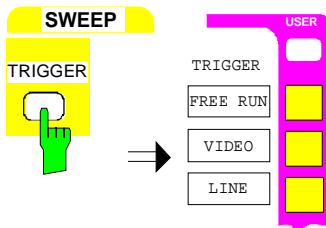

7. Connect the RF output of the SME to the RF input of the FSE.

8. Initiate triggering by means of the display voltage (video trigger)

- Press the TRIGGER key in the SWEEP key field
The TRIGGER menu is opened.

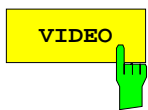

- Press the VIDEO softkey.

A dashed horizontal line is displayed which marks the trigger level.

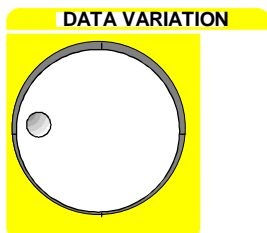

- Set the trigger level using the roll key such that a triggered display is obtained.
(see Fig. 2-15)

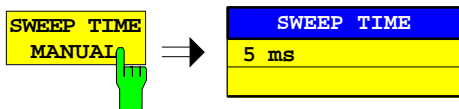

9. Set the sweep time to 100 μs

- Press the SWEEP TIME MANUAL softkey.
The window for entering the sweep time is opened.

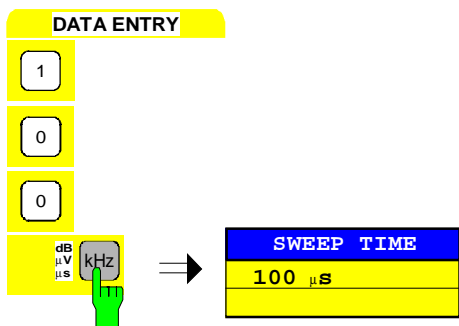

- Enter 100 via the numeric keypad and terminate the entry by pressing the kHz/μs key.

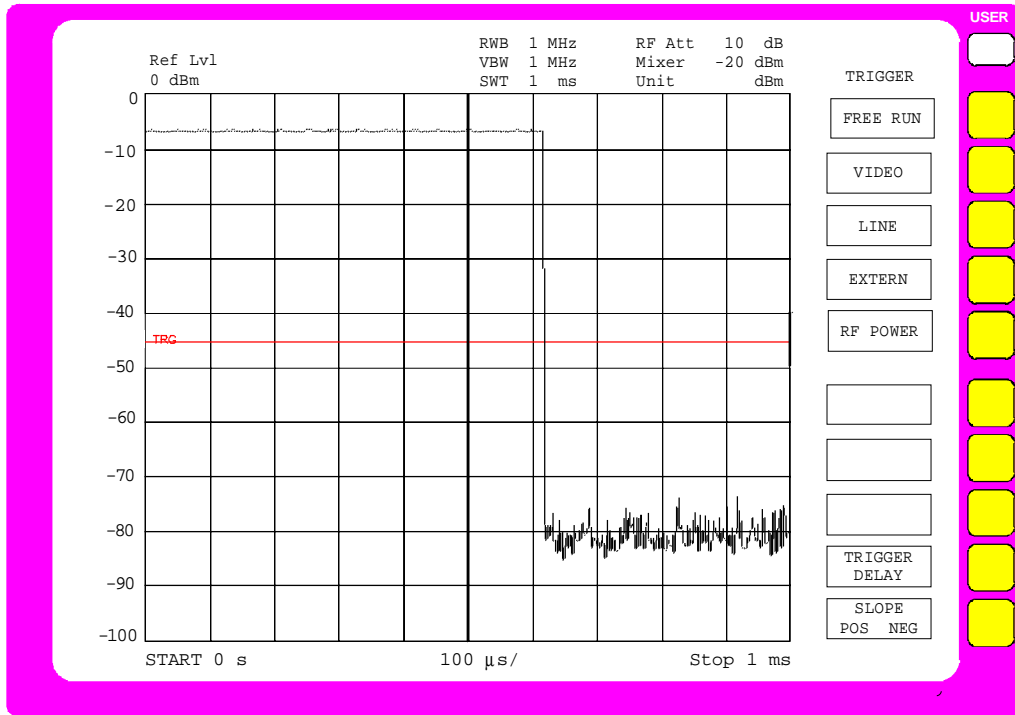
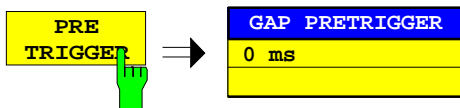
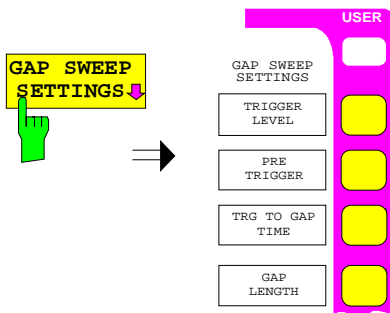
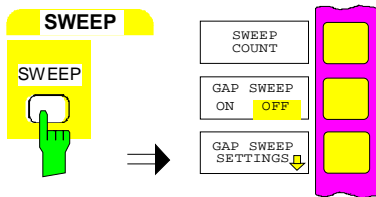

Fig. 2-15 Representation of pulse sequence with video trigger



10. Set the trigger points.

➤ Press the *SWEEP* key in the *SWEEP* keyfield.
The *SWEEP* menu is opened.

➤ Press the *GAP SWEEP SETTINGS* softkey.
The *GAP SWEEP SETTINGS* submenu for setting the trigger points is opened.

➤ Press the *PRE TRIGGER* softkey.
The entry field for the pretrigger is opened.

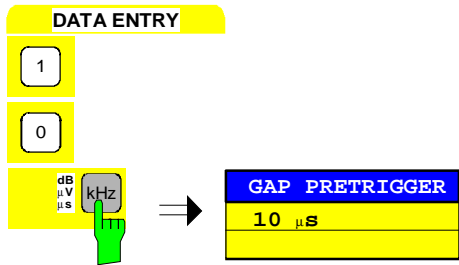

- Enter 10 via the numeric keypad in the entry field and terminate the entry by pressing the kHz/μs key.

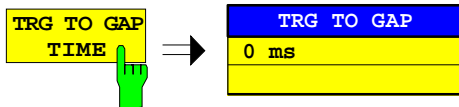

- Press the TRG TO GAP softkey.
The entry field for the trigger-to-gap-time is opened.

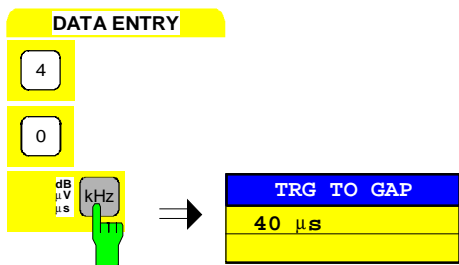

- Enter 40 via the numeric keypad in the entry field and terminate the entry by pressing the kHz/μs key.

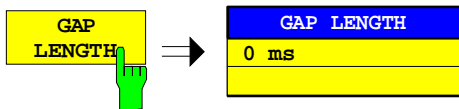

- Press the GAP LENGTH softkey.
The entry field for the length of the time gap is opened.

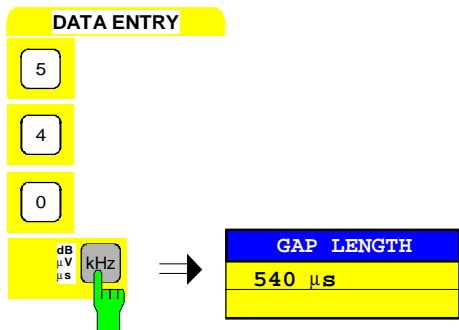

- Enter 540 in the entry field via the numeric keypad and terminate the entry by pressing the kHz/μs key.

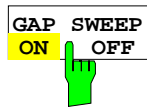
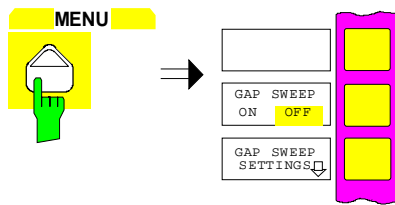

11. Activate the measurement with mask-out of measured value

- Press the menu change key.

The right supplementary menu is opened.

- Press the *GAP SWEEP ON/OFF* key.

The measurement with blanking of measured value is activated. The measurement results are shown in Fig. 2-16

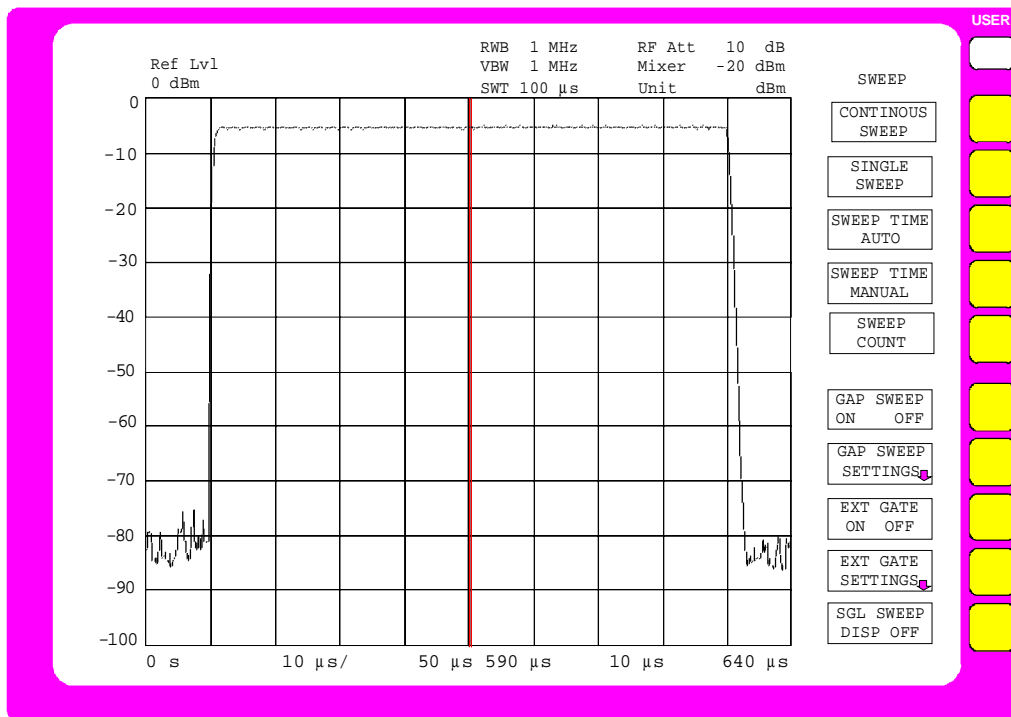

Fig. 2-16 Measured-value blanking for simultaneous display of rising and falling edge of a pulse signal. The position of the gap is indicated by the thick vertical line. The gap time is indicated via the double label 50 μ s and 590 μ s in the time axis.

Contents - Chapter 3 "Manual Operation"

| | |
|--|-------------|
| 3 Manual Operation | 3.1 |
| The Screen..... | 3.2 |
| Diagram Area | 3.3 |
| Displays in the Diagram Area | 3.4 |
| Full Screen..... | 3.9 |
| Split Screen | 3.9 |
| Softkey Area | 3.10 |
| Changing the Menu | 3.11 |
| Setting the Parameters..... | 3.13 |
| Data Entry..... | 3.13 |
| Numeric Keypad on the Front Panel | 3.13 |
| Roll-key and Cursor Keys..... | 3.14 |
| Entry Windows..... | 3.15 |
| Setting Up the Entry Window | 3.15 |
| Editing of Numeric Parameters | 3.16 |
| Editing of Alphanumeric Parameters..... | 3.17 |
| Help Line Editor | 3.17 |
| Table Entry | 3.18 |
| Shifting Mode..... | 3.18 |
| Editing Mode..... | 3.18 |
| Disabling the Control Elements - HOLD Key | 3.19 |
| Setting the Stepsize - STEP Key..... | 3.20 |
| Mouse and External Keyboard Control | 3.21 |
| External Keyboard Control..... | 3.21 |
| Data Entry Windows with Mouse Control | 3.22 |
| Mouse Control of Further Display Elements..... | 3.23 |
| Menu Overview | 3.24 |
| System Key Group..... | 3.24 |
| Configuration Key Group | 3.27 |
| Setup for Instruments with Windows NT Controller Option..... | 3.28 |
| Setup for Instruments with MS DOS Controller Option or without Controller..... | 3.29 |
| Hardcopy Key Group | 3.30 |
| Frequency Key Group..... | 3.31 |
| Level Key Group, Input Key | 3.32 |
| Marker Key Group | 3.34 |
| Lines Key Group | 3.38 |
| Trace Key Group | 3.40 |
| Sweep Key Group..... | 3.41 |
| Memory Key Group..... | 3.43 |
| User Key Group | 3.46 |

3 Manual Operation

Chapter 3 reviews manual operation of the FSE. This includes a description of the screen, menu operation and the setting of parameters. There is an overview of the menus at the end of this chapter.

The functions of the menus are described in detail in Chapter 4. Chapter 2 contains a short introduction which goes through simple measurements step-by-step. The remote control is described in Chapters 5, 6 and 7.

The FSE is menu-controlled via keys and softkeys. Instrument parameters and test parameters can be set directly via softkeys or by entering values in entry fields and by making selections from tables. Softkey are used to select operating modes and the screen mode.

If required, data entry windows and tables also be displayed on the measurement screen.

After switching on the instrument a message about the BIOS version installed is displayed for a few seconds (e.g. "Analyzer BIOS Rev. 1.2").

The results of the self test is displayed next.

```
MAINPROCESSOR
SELFTEST STARTING ...
TESTING CMOS ...
DMA CHANNEL ...
INTERRUPTS ...
NMI ...
BASE MEMORY ...
EXTENDED MEMORY ...
HD CAPACITY ...
INIT FLOPPY DRIVE ...
INIT HD ...

SELFTEST DONE,
SYSTEM IS BOOTING ...
```

Subsequently, the instrument then starts measuring. The type of measurement which was activated prior to last switch-off is performed, as long as no other instrument configuration was selected via *AUTO RECALL* in the *MEMORY RECALL* menu. While the measurement is being performed other menus and measuring modes can be entered simultaneously. The measurement results and the settings of the parameters are displayed on the screen.

The Screen

The screen informs continuously on the results and parameters for the selected measuring functions. The display mode for test results, the softkey labeling and the type of menu depend on the selected measuring function.

The screen is divided into two areas:

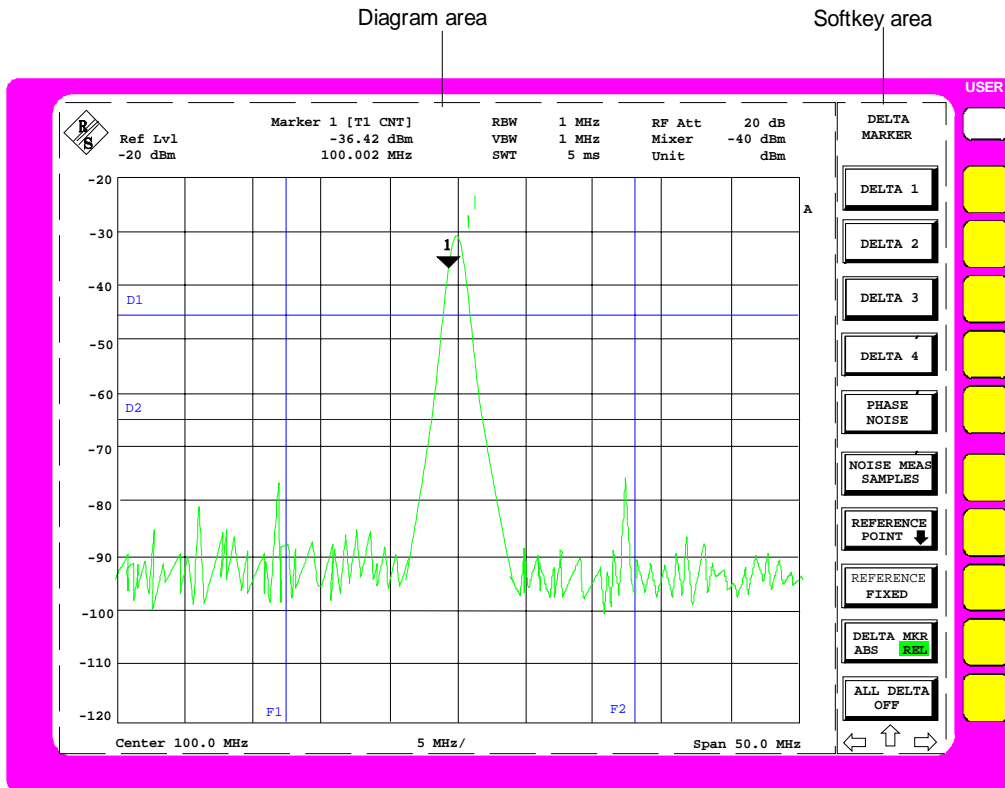

Fig. 3-1 Basic screen areas

Diagram area

This area contains the measuring diagrams and other result displays as well as the parameters and status information which are important for analyzing the results.

Message fields, entry windows and tables may also be shown in this area.

Softkey area

This area displays the instrument functions which can be selected via the softkeys. No other images are superimposed on the softkey area.

Diagram Area

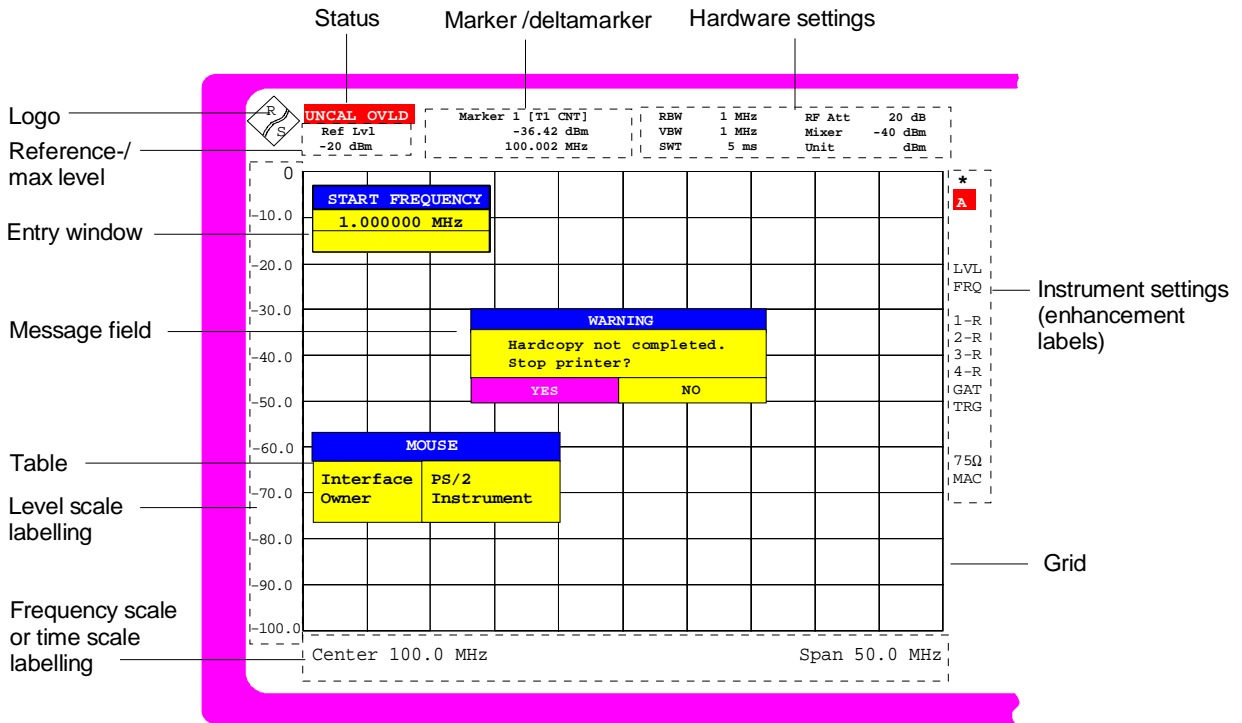

Fig. 3-2 Screen areas in analyzer mode

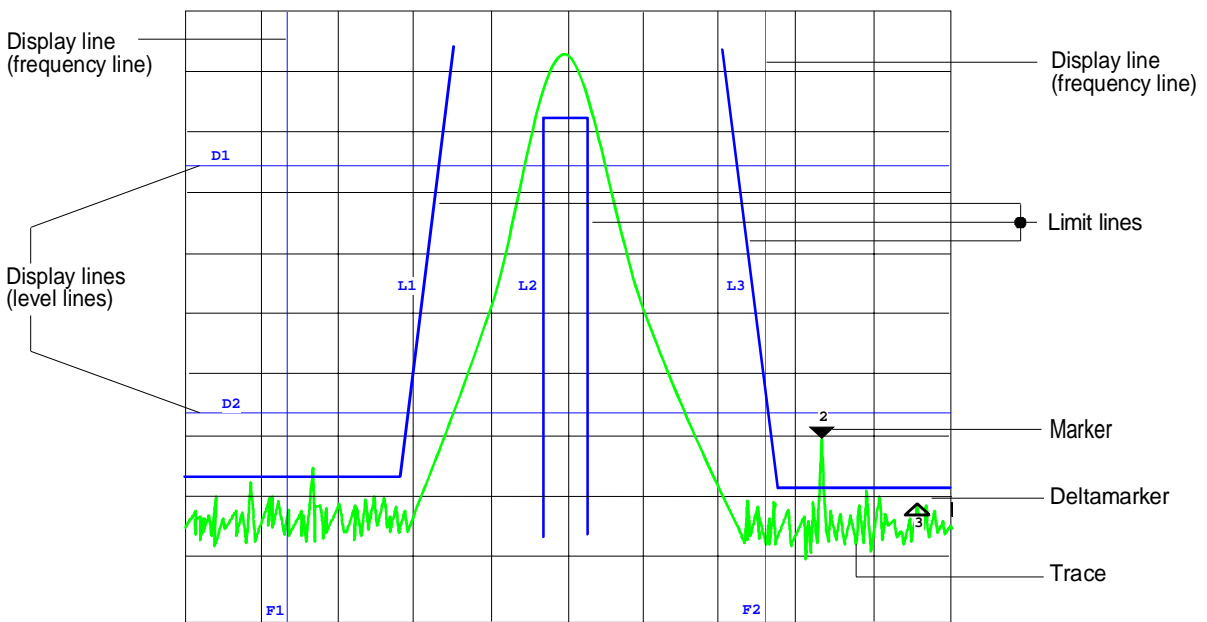

Fig. 3-3 Measuring diagram

Displays in the Diagram Area

The following graphic elements are displayed in the diagram area:

| | |
|---------------------------|--|
| Status information | A status information indicates that a problem has occurred. In addition the status display displays MAX / REF LVL, if the maximum level and the reference level have different values . |
| UNCAL | "UNCAL" is displayed under the following circumstances: <ul style="list-style-type: none"> • no valid correction data (Status CALIBRATION FAILED in table CAL RESULTS), may occur after a cold start following a firmware update ⇒ record correction data (CAL TOTAL) • correction data are switched off (menu CAL, CAL CORR OFF). ⇒ switch on CAL CORR ON or PRESET • Sweep time too short for current instrument settings (span, resolution bandwidth, video band width). ⇒ increase sweep time • resolution bandwidth too small for set symbol rate (Vector Analysis, option FSE-B7): digital demodulation) . ⇒ increase resolution bandwidth |
| OVLD | „Overload“ is displayed when the input mixer is overloaded ⇒ Increase input attenuation |
| IFOVLD | „IF Overload“ is displayed when an overload occurs after the input mixer. ⇒ Increase reference level |
| DIFOVL | „Digital IF Overload“ is displayed when the digital resolution filter is overloaded. ⇒ Increase reference level |
| ExtRef | „External Reference“ is displayed when the instrument is set to <i>REFERENCE EXT</i> (menu <i>SETUP</i>), but the reference signal is missing at the rear panel connector. ⇒ Check input signal of external reference |
| LO unl | „LO unlock“ is indicated when the 1st LO is unlocked (module error). |
| LO Lvl | „LO Level“ is displayed when the output level of the 1st LO is too small (module error). |
| LO LvD | „LO Level Digital IF“ is displayed when the output level of the oscillator of module Digital IF is too small (module error). |
| OCCO | 'OCCO cold' is indicated when the crystal oscillator has not yet reached its operating temperature. This indication vanishes after a few minutes after switch on. |
| UNLD | 'Underload' is displayed when the analyzer is not in its optimal dynamic range. In this case the measuring accuracy is not optimal. This indication is only output in vector analyzer operating mode (option FSE-B7). ⇒ Decrease reference level |

| | |
|--------------------------------|---|
| Marker/Deltamarker | <p>This label displays the position of the last selected marker or deltamarker in the x and y-directions and the marker/deltamarker index. As additional information, 2 fields in square brackets are provided which contain the curve which the marker is assigned to and the active measuring function of the marker indicated. The measuring function of the markers in the second field is indicated by the following abbreviations:</p> <p>CNT frequency counter active TRK signal track active NOI noise measurement active</p> <p>The marker text has the same color as the trace which the marker is assigned to. If, for example, the active marker is assigned to trace 1, and trace 1 is yellow, the marker text will be yellow, too.</p> |
| | |
| Hardware settings | |
| Analyzer mode | Display of the set resolution bandwidth. |
| RBW | Display of the set video bandwidth. |
| VBW | Display of the set sweep time. |
| SWT | Display of the set RF attenuation. |
| RF Att | Display of the user set level at the input mixer (only when level differs from standard settings) (= level of the reference level REF LVL). |
| Mixer | Display of the level unit of the measuring results and the associated setting and test parameters in full length. This label is particularly important for selection of units with more than 4 digits, since they can only be indicated as dB* in the other labels (except for marker). |
| Unit | |
| | |
| Tracking generator mode | Only available with one of the options FSE-B8/9/10/11 |
| TG Lvl | Indication of the set output level of the tracking generator |
| | |
| Vector Analyzer mode | Only available with option FSE-B7 |
| CF | Display of the set center frequency |
| SR | Display of the symbol rate |
| Demod | Display of the switched on demodulator. |
| Standard | Display of the set standard (e.g. GSM) |
| | |
| Grid | X-axis: frequency or time, Y-axis: level |

Instrument settings
(Enhancement Labels)

Display of user instrument settings which influence the measuring result and which are not immediately obvious when viewing the measured values.

- * The current instrument setting is not the same as the setting selected when one of the traces was stored. This occurs under the following circumstances:
 - The instrument setting is modified while a sweep is being performed.
 - The instrument setting is modified in SINGLE SWEEP mode after the end of the sweep and no new sweep is started.
 - The instrument setting is modified after setting the trace to VIEW.

The display will not change until the cause is eliminated by the user. I.e., either a new sweep is started (SINGLE SWEEP mode), or the trace in question is switched to BLANK (all cases).
- A** Identification for screen A. Screen A is activated for the entry of test parameters.
- B** Identification for screen B. Screen B is activated for the entry of test parameters.
- C** If, in the Vector Analyzer (Option FSE-B7) mode, the inphase and quadrature signal is displayed in the measurement window A, the window is subdivided into two diagrams. The upper diagram is marked with an A and the bottom one with C.
- D** If, in the Vector Analyzer (Option FSE-B7) mode, the inphase and quadrature signal is displayed in the measurement window B, the window is subdivided into two diagrams. The upper diagram is marked with an B and the bottom one with D.
- LN** The automatic setting of the input attenuation is set to ATTEN LOW NOISE .
- LD** The automatic setting of the input attenuation is set to ATTEN LOW DISTORTION.
- NOR** Normalization is activated; high accuracy (only with one of the options FSE-B8/9/10/11).
- APP** Normalization is activated; medium accuracy (only with one of the options FSE-B8/9/10/11).
- TDF** An antenna correction factor (*TRANSDUCER FACTOR*) is switched on.
- TDS** A set of antenna correction factors (*TRANSDUCER SETS*) is switched on.
- LVL** A level offset $\neq 0$ dB has been set. A level offset of the installed tracking generator (option) leads to the same display.
- FRQ** A frequency offset $\neq 0$ Hz has been set.
- SGL** The sweep is set to SINGLE SWEEP.

| | |
|----------------------|---|
| 1-<n> | Subtraction Trace 1 - Trace <n> active (<n>: numeric value) or subtraction Trace 1 - Reference Line active (<n>: R) |
| 2-<n> | Subtraction Trace 2 - Trace <n> active (<n>: numeric value) or subtraction Trace 1 - Reference Line active (<n>: R) |
| 3-<n> | Subtraction Trace 3 - Trace <n> active (<n>: numeric value) or subtraction Trace 1 - Reference Line active (<n>: R) |
| 4-<n> | Subtraction Trace 4 - Trace <n> active (<n>: numeric value) or subtraction Trace 1 - Reference Line active (<n>: R) |
| <n>AP | For trace <n> (n = 1 to 4) the detector is set to AUTOPEAK. |
| <n>MA | For trace <n> (n = 1 to 4) the detector is set to MAX PEAK. |
| <n>MI | For trace <n> (n = 1 to 4) the detector is set to MIN PEAK. |
| <n>SA | For trace <n> (n = 1 to 4) the detector is set to SAMPLE. |
| <n>AV | For trace <n> (n = 1 to 4) the detector is set to AVERAGE. |
| <n>RM | For trace <n> (n = 1 to 4) the detector is set to RMS. |
| GAT | The frequency sweep is controlled via the <i>EXT TRIG/GATE</i> connector. |
| TRG | The instrument is not triggered in <i>FREE RUN</i> mode. |
| EXT | The unit is configured for operation with external reference |
| 75 Ω | The input impedance of the unit is set to 75 Ω. |
| MAC | Macro recording active. |
| PRN | A printout is taking place. PRN overwrites the enhancement label MAC. |
| <n>VIEW | Trace <n> (n = 1 to 4) is set to VIEW |
| <n>AVG | Trace <n> (n = 1 to 4) is set AVERAGE |
| MIX | The external mixer output is switched on (option FSE-B21). |
| SID | External mixer output: SIGNAL ID is switched on (option FSE-B21). |
| AID | External mixer output: AUTO ID is switched on (option FSE-B21). |

Frequency axis labeling Display of the x-scaling.

`{123.4 ms/Div }`

The distance between two grid lines is displayed in this label.

`{Center 1.2345678901234 GHz}`

The set center frequency or start frequency is displayed in this label depending on whether the keys CENTER/SPAN or START/STOP were last pressed.

`{Start 1.2345678901234 GHz }`

If span = 0 Hz, the center frequency is always displayed.

`{Span 1.2345678901234 GHz}`

`{Stop 1.2345678901234 GHz}`

`{Trigger 1.234 ms}`

The set frequency range (*SPAN*) or the stop frequency is displayed, depending on whether the keys CENTER/SPAN or START/STOP were last pressed.
If span = 0 Hz, the trigger moment (*PRETRIGGER*) is displayed.

Optional labeling

Optional indication of date, time and comment.

`14.Jun 97 12:13`

Level axis labeling

Display of the y-scaling.

Entry window

The data entry window is superimposed in the diagram area, if required.

Reference level/ Max. level

Display of the set reference level or combined display of maximum level and reference level .

Limit lines

Limit lines are the upper and/or lower limits for level curves or spectral distributions.

Traces 1 to 4

Up to 4 traces can be displayed simultaneously.

Display lines

Utilities for trace analysis.

The FSE provides two display modes:

- Full Screen: 1 window, all traces are displayed in one screen.
- Split Screen: 2 windows, traces, grid and labels are distributed on the two screens.

Full Screen

In the full-screen mode, the settings and measurements are performed in the active visible window. All indications on the screen refer to this window. The designation (SCREEN A or SCREEN B) is inserted as enhancement label A or B on the right diagram margin.

The *DISPLAY* key is used to switch between the windows. The current measurement is terminated when its window goes blank.

Switching from split-screen to full-screen mode is performed in menu *SYSTEM DISPLAY*.

Split Screen

In the Split Screen mode, the screen is divided into two halves.

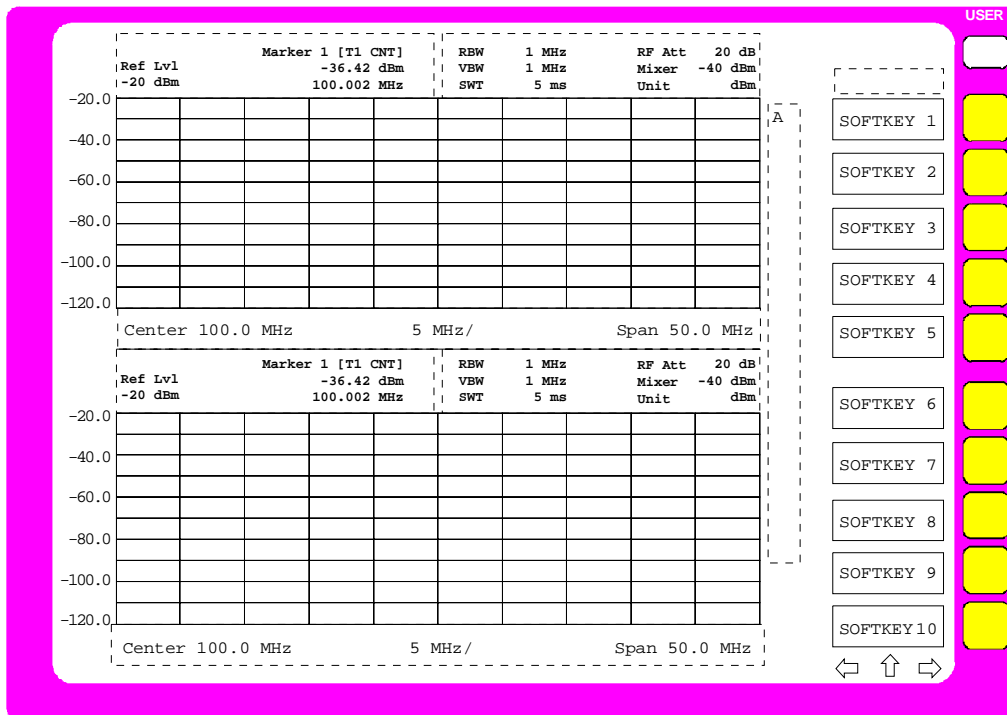

Fig. 3-4 Split Screen mode

The upper half is always assigned to Screen A, the lower to Screen B. The measurement settings can be selected independently for both screens. E.g., a spectrum may be displayed in Screen A and a time amplitude in the time range is displayed in Screen B. The window for entry of the measuring parameters or the marker operation is selected using the *DISPLAY* key.

The indications which apply only to one window appear in the margin of the associated diagram. Indications which apply to the two windows are displayed between the diagrams.

The assignment of traces to the windows is fixed and cannot be modified.

Table 3-1 Assignment of traces to windows with split screen in the signal or vector analyzer mode

| | | | |
|----------|------------------|----------|------------------|
| Trace 1: | upper (screen A) | Trace 3: | upper (screen A) |
| Trace 2: | lower (screen B) | Trace 4: | lower (screen B) |

The two windows can be subdivided into two measurement diagrams. This applies to separate display of measurement values, eg to the display of the inphase and quadrature signal in vector analysis. Screen A is divided into diagrams A and C, screen B is divided in diagrams B and D.

Softkey Area

The layout of the softkey area is independent of the operating mode. It consists of the following graphic elements:

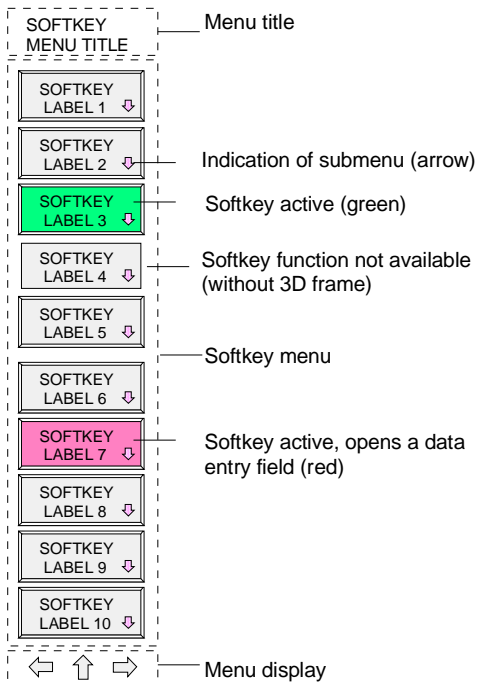

Fig. 3-5 Layout of the softkey area

The softkeys have different functions depending on the instrument state. Therefore, their labeling changes. The current state of the softkeys is indicated by color coding. The color code is factory-set as follows:

Table 3-2 Factory-set color code for softkeys

| Softkey color | Meaning |
|---------------|----------------------------------|
| gray | Softkey off |
| green | Softkey on |
| red | Softkey on and data entry active |

These colors can be changed by the user as desired in the *SYSTEM DISPLAY-CONFIG DISPLAY* menu.

A softkey is switched on or off by pressing it. If a mouse is connected to the instrument, the softkey label on the display can be clicked.

Softkey labels are not displayed if the function they represent is not available. There are two cases:

- If an instrument function depends on an option, and this option is not fitted, the associated softkey label will not be displayed.
- If the instrument function is not available temporarily due to specific settings, the softkey is displayed without the 3D frame.

Changing the Menu

With manual control, the FSE can be operated via the front-panel keys, the external keyboard or with a mouse.

Operation is menu-controlled. Various **softkey menus** are displayed depending on the instrument status. The menus are organized using a tree structure. The start menu (the root of the menu tree) is always called by pressing a hardkey. The softkeys are then used to branch into further menus (submenus).

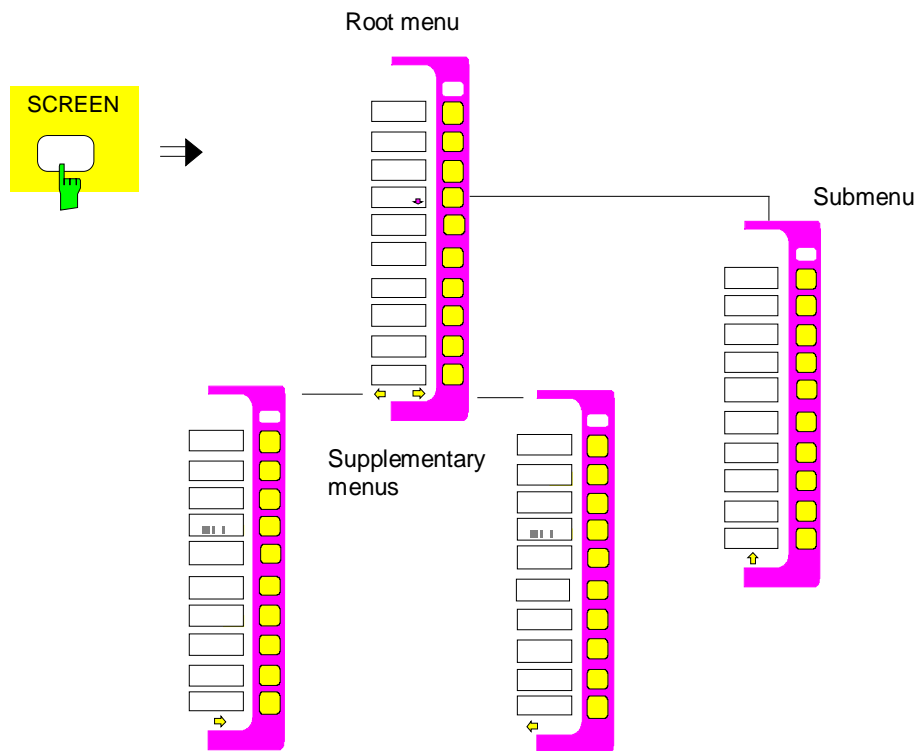

Fig. 3-6 Theory of menu selection

Each softkey menu consists of max. 30 softkeys, 10 softkeys being arranged in a main menu, 10 in a left-hand supplementary menu and 10 in a right-hand supplementary menu. In contrast to empty main menus, empty supplementary menus are not displayed. Arrows at the lower edge of the softkey area indicate whether a supplementary menu exists or not.

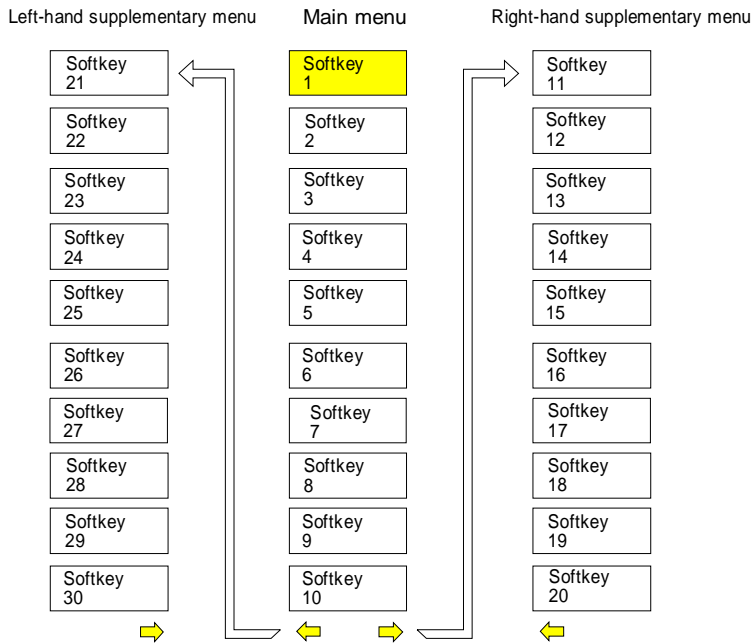

Fig. 3-7 Switching between main menu and supplementary menu

The menu arrows help to orient inside the menu tree.

Examples: This menu has a right-hand and a lefthand supplementary menu. It is the root menu since there is no arrow.

Only a right-hand supplementary menu or the upper menu can be accessed from this menu.

MENU

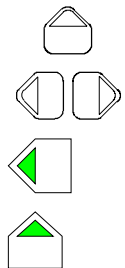

The MENU keys allow for selecting the main menu and the supplementary menus. If a mouse is connected to the instrument, the menu arrows can be selected to enter the respective menus. The MENU keys have the following functions:

When this key is pressed, the FSE enters the left-hand supplementary menu.

This key is pressed to call the upper menu which is located in the next higher hierarchical level in the menu tree. Several menus provide for automatic change, i.e., return to the next higher menu is caused automatically after pressing a softkey.

The right-hand supplementary menu is selected by pressing this key. A supplementary menu cannot be selected from another supplementary menu but only via the main menu.

Submenu are always selected with a softkey.

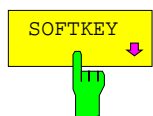

The labeling of all softkeys which call a submenu includes an arrow.

The softkeys are masked out in remote mode and during macro processing.

Setting the Parameters

Data Entry

Instrument parameters can be entered in an entry window or in a table via the numeric keypad on the front panel (*DATA ENTRY*), an external keyboard and the roll-key.

The numeric keypad *DATA ENTRY* is provided for entry of numeric parameters (e.g., the start frequency). The roll-key is used for fast incrementing or decrementing of numeric parameters with a defined step size.

It is advisable to use the external keyboard for definition of alphanumeric parameters (e.g., file names) since the front panel does not allow for entry of letters. If no external keyboard is provided, the help line editor is called automatically for entry of alphanumeric parameters.

Numeric Keypad on the Front Panel

The keys are assigned the following functions:



Number keys



Changes the sign of a numeric parameter. A "-" is inserted at the cursor position in the case of an alphanumeric parameter.



Inserts a decimal point "." at the cursor position in the numeric string.

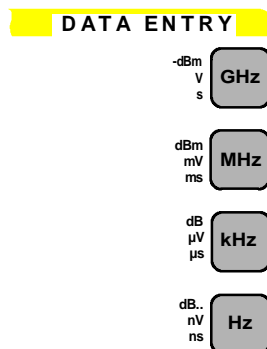

Append the selected unit to the numeric value that has been entered

The unit keys are all assigned the value "1" if quantities are indicated without dimensions in order to prevent faulty operations. The unit keys, therefore, also adopt the function of an ENTER key. The same applies to alphanumeric entries.

DATA ENTRY



Adds an exponent (E-xx) to the end of the numeric string.

DATA ENTRY



Deletes the character to the left of the cursor with numeric entry.
Toggles between the current parameter and the previous value - but not when an entry is being made (UNDO function).

DATA ENTRY



Closes the entry field when entry has been made.
Aborts the entry before it has been confirmed.
Closes the system message windows.

Roll-key and Cursor Keys

DATA VARIATION

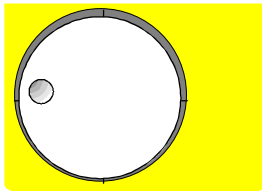

The roll-key has several functions.

- With numeric entry, the instrument parameter is incremented (turning clockwise) or decremented (turning counterclockwise) at a defined step size.

The step size may be equal to or smaller (e.g., 1/10) than the step size being defined for the cursor keys (see description of the *STEP* key).



- In tables, the roll-key can be used to shift the cursor horizontally or vertically when no entry window is open. The direction (horizontal/vertical) is changed with the cursor keys.
- The roll-key is used with the help-line editor to select the individual letters.
- It can be used to shift markers, display lines, limit lines etc.

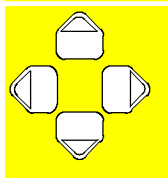

As the roll-key is turned faster, the step size increases so speeding up the setting procedure.

Cursor keys:

DATA VARIATION



With numeric entry, the keys  or  are used to increase or decrease the instrument parameter by the selected step size. The keys are disabled With alphanumeric entry, the keys are used to toggle between the editing line and the help line editor.

The keys  and  are used to shift the cursor to the required position within the (alpha)numeric editing line..

In tables, the cursor keys are used to shift the cursor between the lines and columns of the table.

Entry Windows

Setting Up the Entry Window

The instrument parameters are not entered at the location where the parameter is displayed but in an individual entry window.

The entry window is called by a softkey or a hardkey and is used for definition of numeric or alphanumeric instrument parameters (START FREQUENCY by way of example):

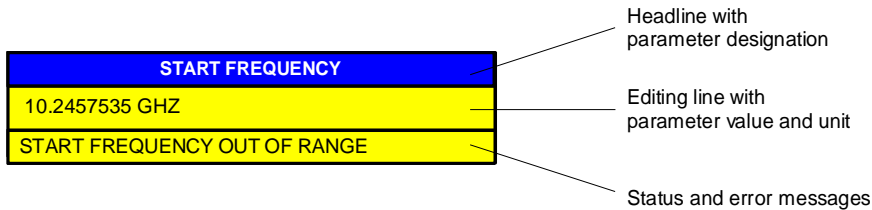

Fig. 3-8 Setup of an entry window

Subsequent to calling the entry window the current parameter value including the unit is displayed in the editing line. Status and error messages which refer to the current entry are displayed in the third and (optionally) fourth line.

The entry window is displayed in the left upper edge of the active measuring window with the default setting. When a mouse is connected to the instrument, open entry windows can be shifted to any position on the screen provided that they do not cover the softkey line. The new position is valid until measuring window is selected. The data entry window is represented transparent or non-transparent, as required.

Alphanumeric parameters are displayed as a simple character string in the editing line. Numeric parameters which consist of mantissa, exponent and unit are set up as follows:

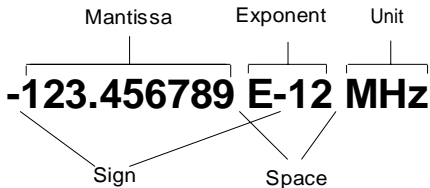

Fig. 3-9 Setup of numeric parameters

Mantissa: The first character is the sign of the mantissa, the positive sign is not displayed. The actual numeric value follows. The number of digits depends on the instrument parameter. The cursor may be shifted to the first digit of the mantissa at maximum, however, it may not precede the sign. The decimal point can be set as required.

Exponent: The exponent is separated from mantissa by a space character. The sign field of the exponent follows the "E", the positive sign "+" being not displayed similar to the representation of the mantissa. The cursor skips the "E" and the sign field. Two characters are fixed for the exponent value.

Unit: The unit (not represented in editing mode) is separated from the exponent by a space character.

The number of digits which can be entered for each instrument parameter is limited by the width of the input field only, but not by the amount which is physically enabled. (Example: Levels should be indicated with two decimals. The user may, however, enter as many decimals as desired - the entered value is rounded accordingly).

There are two types of entry windows:

| |
|------------------------------|
| START FREQUENCY |
| 10.2457535 GHZ |
| START FREQUENCY OUT OF RANGE |

The editing line of the entry window for numeric parameters allows for display of up to 24 characters. Horizontal scrolling is not possible in the editing line.

| |
|--------------------------|
| HARDCOPY TITLE |
| BANDPASS-FILTER TEST 23A |
| |

The editing line of the entry window for alphanumeric parameters allows for display of up to 60 characters (cf. display section). Maximum 256 characters may be entered. Horizontal scrolling is possible.









If no external keyboard is provided, the three-line entry window is replaced by a letter field which allows for individual selection of characters using the cursor keys (see help line editor).

Editing of Numeric Parameters

Calling the entry window:

- Subsequent to calling the entry window, the current value of the numeric parameter including the unit is displayed in inverted color. The cursor is not displayed in this state. The transparent data entry window has no background color.
- The entry window is closed upon pressing the key CLR.

Editing mode:



- Pressing a number, sign or decimal point key causes the value and unit to be deleted. The new value is output left-justified. The individual characters are entered in insert mode. If the maximum amount of characters for the mantissa or the exponent has been entered, no further entry is possible (no horizontal scrolling). If characters are positioned to the right of the cursor, they are shifted right when reaching the maximum length and get lost.
- Pressing the keys DATA VARIATION  or  causes normal representation of the current value. The unit is no longer displayed and the cursor precedes the first digit of the mantissa () or follows the last digit entered (). The DATA VARIATION keys  and  change the numeric value of the cursor.
- Pressing the DATA VARIATION keys  or  or the roll-key causes the original parameter value to be restored and modified according to the defined step size for this parameter.
- The data management of the instrument stores the previous value of a parameter in addition to the current value. The BACK key allows for toggling between these two values.

Termination and abortion of entry:

- The editing mode is terminated by pressing a unit key. The validity of the new parameter value is checked and accepted for the instrument setting. If an error occurs, a corresponding error message is displayed in the status line of the editing field, e.g., "Out of range", "Value adjusted", etc.
- Editing of a parameter can be aborted by pressing the key CLR. The original parameter is then displayed again. The entry window is closed by pressing the CLR key again.
- Pressing a key or softkey subsequent to starting the entry causes the entry to be aborted and the entry window to be closed. If the same softkey which has opened the entry window is activated during entry, the original value is restored and displayed.

Editing of Alphanumeric Parameters

Generally, the regulations for numeric parameters analogously apply for alphanumeric parameters. Note the exceptions given below:

- Alphanumeric parameters are not displayed with a unit.
- The four unit keys adopt the function of the ENTER key.
- Horizontal scrolling is possible in the editing line.
- Incrementing or decrementing cannot be effected via the keys ,  or the roll-key.
- Pressing the sign key causes a "-" character to be inserted at the cursor position, the decimal point key causes insertion of a point ".".
- The exponent key has no function.

Help Line Editor

The help line editor allows for labelling or text entries to be made without an external keyboard being required. In this case, a field containing letters and special characters is added to the standard entry window. The help line editor is displayed automatically if no external keyboard is provided and an entry window for alphanumeric entry is opened.

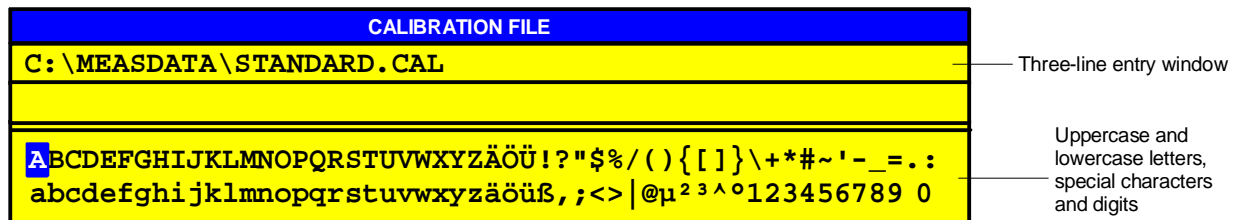

Fig. 3-10 Help line editor



- The keys  and  are used to toggle between the editing line and the help line editor.
- The cursor can be positioned to the required character in the help line editor using the cursor keys and the roll-key.
- A character is entered in the editing line by pressing any of the unit keys.
- If the cursor is already located in the editing line, pressing a unit key terminates data entry.

Table Entry

The FSE uses numerous tables for indication and configuration of instrument parameters. The tables differ very much in the number of lines, columns and inscriptions and have a different functionality.

Tables are represented in a non-transparent form. The size is predefined and cannot be modified. If a mouse is connected, the tables may be shifted on the display without covering the softkeys. Tables can be superimposed by entry windows or suchlike.

Tables are mostly coupled to a softkey menu which provides further functions for editing table entries, e.g., deletion of tables, copying lines or columns, marking of table elements, restoring of default states etc. Another kind of tables is exclusively used for indication of instrument parameters and cannot be edited.

The definition of individual tables and the operation of particular editing functions can be looked up in the reference section with the description of the corresponding softkey menu.

The basic concept of operation is, however, the same for all tables. A differentiation is made between shifting mode and editing mode.

Shifting Mode

This mode is active subsequent to opening a table. The **cursor** is shifted between the table elements by means of the cursor keys. The table element which is below the cursor is represented in inverted color.

| TRANSDUCER SET | | | |
|----------------|----------|--------------|---|
| | Name | Unit | |
| | Antenna | dB μ V/m | |
| | Ant_Cab2 | dB μ V/m | |
| | Ant_Pre | dB μ V/m | |
| ✓ | Ant_Cab1 | dB μ V/m | ← |
| | Probeset | dB μ A | |
| | — | | |

Cursor

Fig. 3-11 Shifting mode

Editing Mode

A table element which is marked by a cursor can be edited as follows:

- by pressing one of the unit keys on the front panel or the *ENTER* key on the external keyboard.
- by a double-click of the mouse on the table element. If the clicked element is not yet marked by the cursor, the letter is positioned on the element, additionally.
- For numeric or alphanumeric instrument parameters, the editing operation may be started by entry of any number or letter on the front panel or on the external keyboard.

The data entry window, the selection list or the toggle editor are provided for this purpose.

After the editing operation has been terminated, the table enters the shifting mode again. The cursor is positioned automatically on the next table element.

Disabling the Control Elements - HOLD Key

The individual softkeys have the following functions:

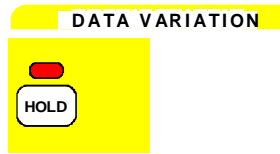

The functions of the *HOLD* menu allow for disabling individual control elements or the complete instrument control. The LED above the *HOLD* key indicates that either the function *LOCK DATA* or *LOCK ALL* has been activated. The control can be enabled again by successively pressing the two *UNLOCK* softkeys in any order.

Switching off the instrument resets control such that the instrument can be normally operated again after subsequent switch-on.



After selecting the two *UNLOCK* softkeys, the instrument keyboard is enabled again. The LED above the *HOLD* key goes out.

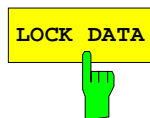



Selection of softkey *LOCK DATA* causes the roll-key to be disabled in order to prevent a parameter from being varied by mistake.



Selection of *LOCK ALL* softkey disables the complete front panel (including the *PRESET* key and roll-key, not including the *UNLOCK* softkeys), the mouse and all keys of the external keyboard. Exit from the *HOLD* menu is no longer possible. Control is enabled again by actuating the two *UNLOCK* softkeys.

Setting the Stepsize - STEP Key

A number of numeric instrument parameters allow for step-by-step incrementing or decrementing the value in the editing line of the entry window using the keys  or  or the roll-key. The stepsize used with the cursor keys can be specified for the selected parameters in the *STEP* menu.

- Notes:**
- It is not possible to set the stepsize by all of the numeric parameters.
 - An extended *STEP* menu is available by some parameters. The extra functions are described by the respective parameter.
 - Setting the step size has no effect on the roll-key (the resolution of the roll-key is higher than that of the step size function)

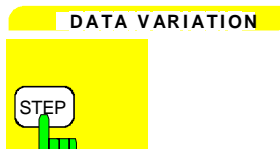

The *STEP* key opens the *STEP* menu for entry of the stepsize.

The stepsize of an instrument parameter can only be varied when this parameter is edited in an entry window.

The softkeys in the *STEP* menu are disabled if no instrument parameter is being varied or if the parameter being edited does not support stepsize variation (as is the case by all of the alphanumeric parameters).

The key  leads to exit from the *STEP* menu and automatic return to the previously active menu.



The softkey *STEPSIZE AUTO* causes the stepsize for the corresponding instrument parameter to be set automatically and be continuously varied with varying instrument settings (in accordance with other parameters).

Example:

The stepsize of the *CENTER* frequency depends on the selected span.



The softkey *STEPSIZE NORMAL* calls an entry window for definition of a stepsize by the user. The parameter whose stepsize is varied, is displayed in the headline of the entry window:

| START FREQUENCY | STEPSIZE |
|-----------------|----------|
| 100 kHz | |

The stepsize remains constant until a new value is entered or until the *STEPSIZE AUTO* softkey is activated. It is no longer coupled to other instrument parameters.

Mouse and External Keyboard Control

External Keyboard Control

The connection of an external keyboard provides additional characters for the entry (letters and special characters). It is permitted to use both, front panel keys and the external keyboard, for control. The number, cursor and sign keys have the same effect as the corresponding front panel keys. A few keys of the external keyboard provide an extended functionality with entries or tables which is described in the following table. The table shows the external keyboard key combinations through which the functions of the front panel keys can be emulated.

- Note:**
- The key combination <ALT><S (German keyboard) or <ALT> <SYSREQ> (English keyboard) switches between the instrument display screen and the controller display screen (for an installed option FSE-B15, controller option).
 - In instrument mode, the key combination <ALT> <F1> switches the keyboard between the US-American language and the language selected in the GENERAL SETUP menu (instruments without controller option).

Table 3-3 Front Panel Keyboard Emulation

| FSE front panel keys | | Key assign. for the ext. keyboard |
|--------------------------|---|---|
| Softkeys: | SK1 SK2 SK3 SK4 SK5 SK6 SK7 SK8 SK9 SK10 | F1 F2 F3 F4 F5 F6 F7 F8 F9 F10 |
| Menu select: | Menu left Menu right Menu up | CTRL ← CTRL → CTRL ↑ |
| Cursor control: | Cursor left Cursor right Cursor up Cursor down | ← → ↑ ↓ |
| Roll-key: | Turn left Turn right | SHIFT ↑ SHIFT ↓ |
| Numeric keys: | 0 to 9 | 0 to 9 |
| Units keys: | GHz... MHz... kHz... Hz... | ALT-G ALT-M ALT-K <ENTER> |
| Edit keys: | Clear Backspace | <ESC> BACK |
| Misc. data entry keys: | Exponent "Exp" Sign "+/-" Decimal point". | ALT-E - . |
| Hold key: | Hold | SHIFT-F1 |
| User menu: | User | SHIFT-F2 |
| System keys: | Preset Cal Display Info | SHIFT-F4 ALT-F12 ALT-F10 SHIFT-F5 |
| Configuration key group: | Mode Setup | ALT-F2 SHIFT-F8 |
| Hardcopy key group: | Start Settings | SHIFT-F6 SHIFT-F9 |

| FSE front panel keys | | Key assign. for the ext. keyboard |
|--------------------------------|--|---|
| Status key group : | Local | SHIFT-F3 |
| Frequency key group: | Start Stop CenterCenter Span | CTRL-F7 CTRL-F8 CTRL-F9 CTRL-F10 |
| Level key group: | Ref Range Input Cal | CTRL-F11 CTRL-F12 ALT-F11 ALT-F12 |
| Marker key group : | Normal Search Delta → Mkr | CTRL-F1 CTRL-F2 CTRL-F3 CTRL-F4 |
| Lines key group : | Display Limit | CTRL-F5 CTRL-F6 |
| Traces key group : | 1 2 3 4 | ALT-1 ALT-2 ALT-3 ALT-4 |
| Sweep key group : | -- -- -- Coupl. Sweep Trigger | ALT-F3 ALT-F4 ALT-F5 ALT-F6 ALT-F7 ALT-F8 |
| Memory key group: | Config Save Recall | SHIFT-F10 SHIFT-F11 SHIFT-F12 |
| Data entry key group : | Step | SHIFT-F7 |
| Letters and special characters | | A to Z (ext.) a to z (ext.) Special characters (ext.) |
| Edit key | | Delete |
| Cursor control | | Home End Page up Page down |

Data Entry Windows with Mouse Control

With a mouse being connected, additional functions are provided in the entry windows. Therefore, buttons are displayed in the entry window.

Essentially, the definitions which have been made for all types of entry window also apply for mouse control. However, note the following deviations:

- The so-called close-button is displayed on the left margin of the headline. Selecting this button via the mouse aborts the entry and closes the entry window. This corresponds to the function of the CLR key with manual control.
- In the numeric entry window, two buttons (↕) are displayed on the left margin of the editing line. Simply clicking the buttons causes the parameter in the editing line to be incremented or decremented (similar to the keys ⬆ / ⬇ or the roll-key with manual control).
- The cursor can be positioned in the entry line by clicking a character using the mouse.
- A character in the letter window of the help line editor can be selected by a single click. A double click copies the character from the letter window into the editing line.
- Open entry windows can be shifted across the complete screen using the mouse; they must not, however, be superimposed on the softkey line. Shifting is performed by clicking the headline and pushing the mouse while the mouse-key is being pressed.

Example: Numeric entry window with mouse control

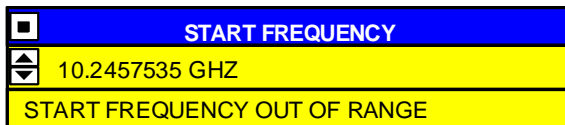

Mouse Control of Further Display Elements

All display and control elements (enhancement labels, softkeys, function fields, display and limit lines) which can be displayed on the display screen can also be controlled by the mouse. Each softkey or key is assigned to a display element.

Double-clicking an display or control element opens the corresponding softkey menu. The assignment of softkeys/keys to display elements is shown in the following table.

Klicking the right mouse key call all softkey menus one after the other.

Table 3-4 Mouse Control of Display Elements

| Display element for mouse control. | Assigned softkey or key |
|---|--|
| Display field for Softkey 1 to Softkey 10 | Softkey 1 to Softkey 10 |
| Display field for menu arrow: right/center/left | Key right/center/left supplementary menu |
| Enhancement labels * PA PS UNS LVL FRQ 1-x 2-x 3-x 4-x TRG DC 75Ω MAC | -- SETUP key SETUP key COUPLING key REF key CENTER key TRACE 1 key TRACE 2 key TRACE 3 key TRACE 4 key TRIGGER key INPUT key INPUT key USER key |
| Status display UNCAL OVLD ERR | CAL key REF key INFO key |
| Display fields above the diagram Ref. Level / Max Level Marker RBW VBW SWT RF Att Mixer Unit | REF key NORMAL key COUPLING key COUPLING key COUPLING key INPUT key INPUT key REF key |
| Display fields below the diagram Start Stop Center Span Trigger /Div | START key STOP key CENTER key SPAN key TRIGGER key -- |

Menu Overview

System Key Group

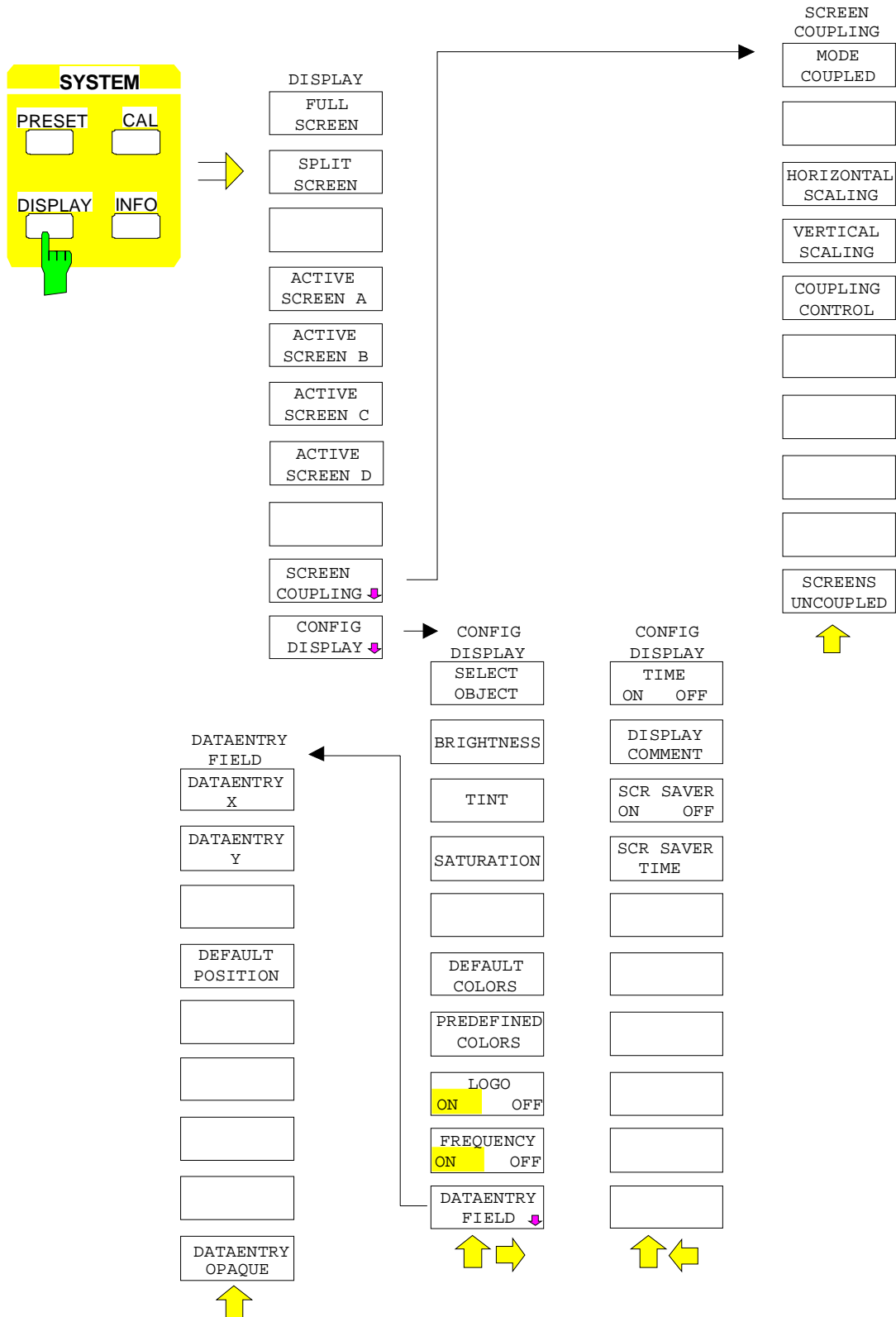

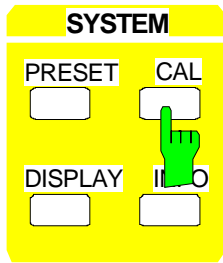

Mod 30

with option
FSE-B7 only

| CALIBRATE | | CALIBRATE | |
|--------------------|--|-------------|--|
| CAL SHORT | | CAL RESULTS | |
| CAL TOTAL | | | |
| CAL RES BW | | | |
| CAL LOG | | | |
| CAL LO SUPP | | | |
| CAL I/Q | | | |
| | | | |
| | | | |
| PRESEL PEAK | | PAGE UP | |
| CAL CORR ON OFF | | PAGE DOWN | |



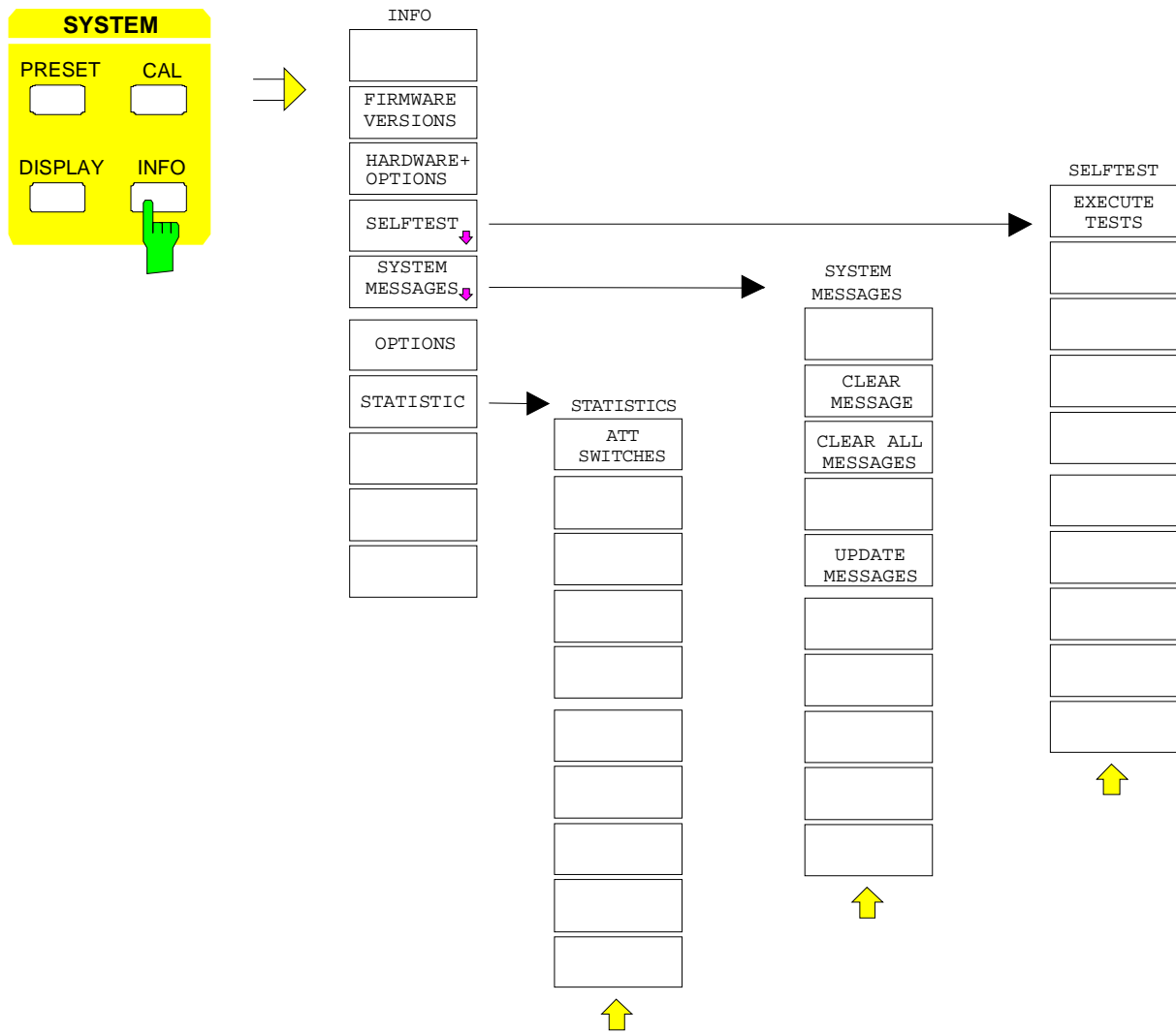

Configuration Key Group

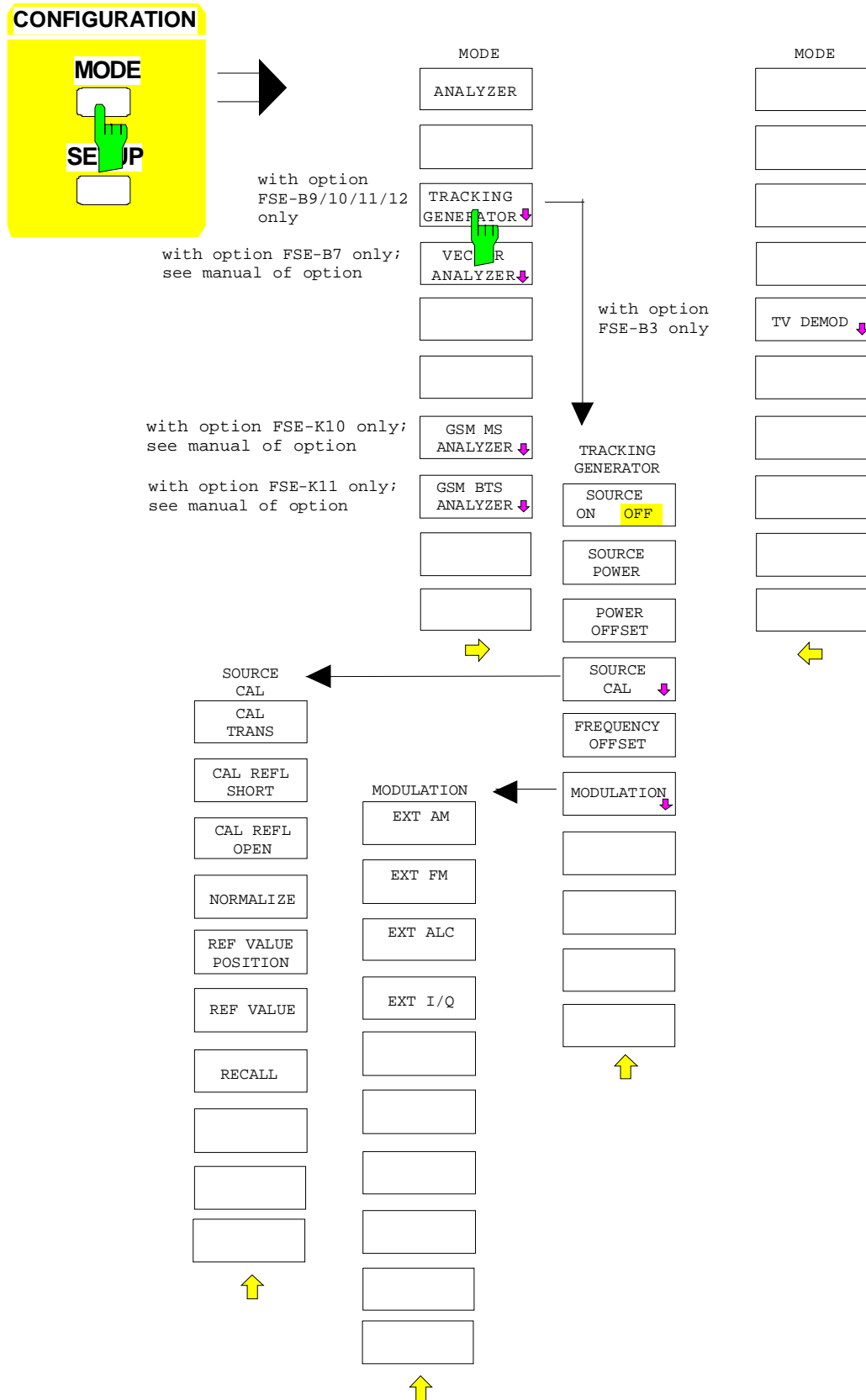

Setup for Instruments with Windows NT Controller Option

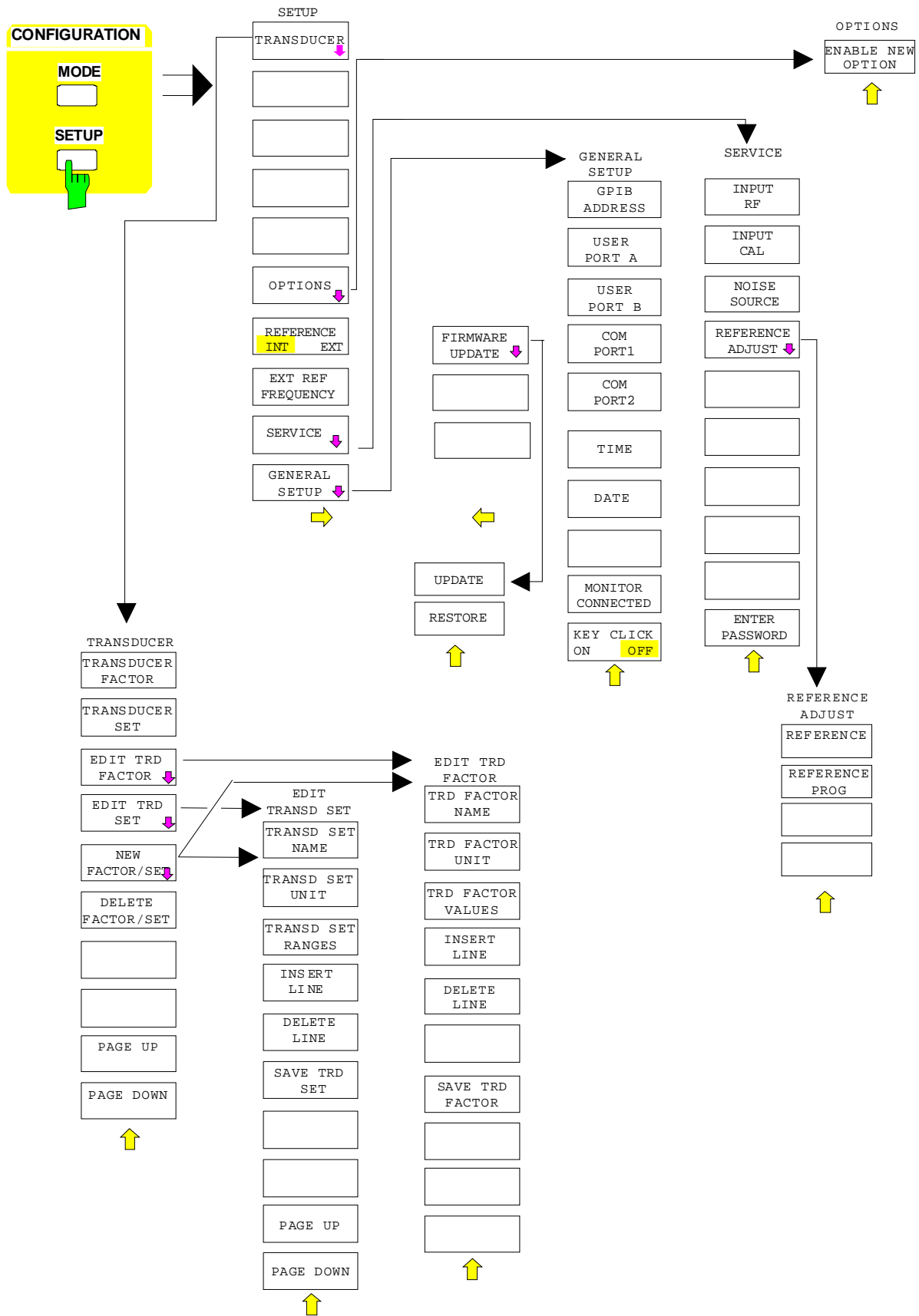

Hardcopy Key Group

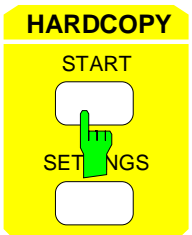
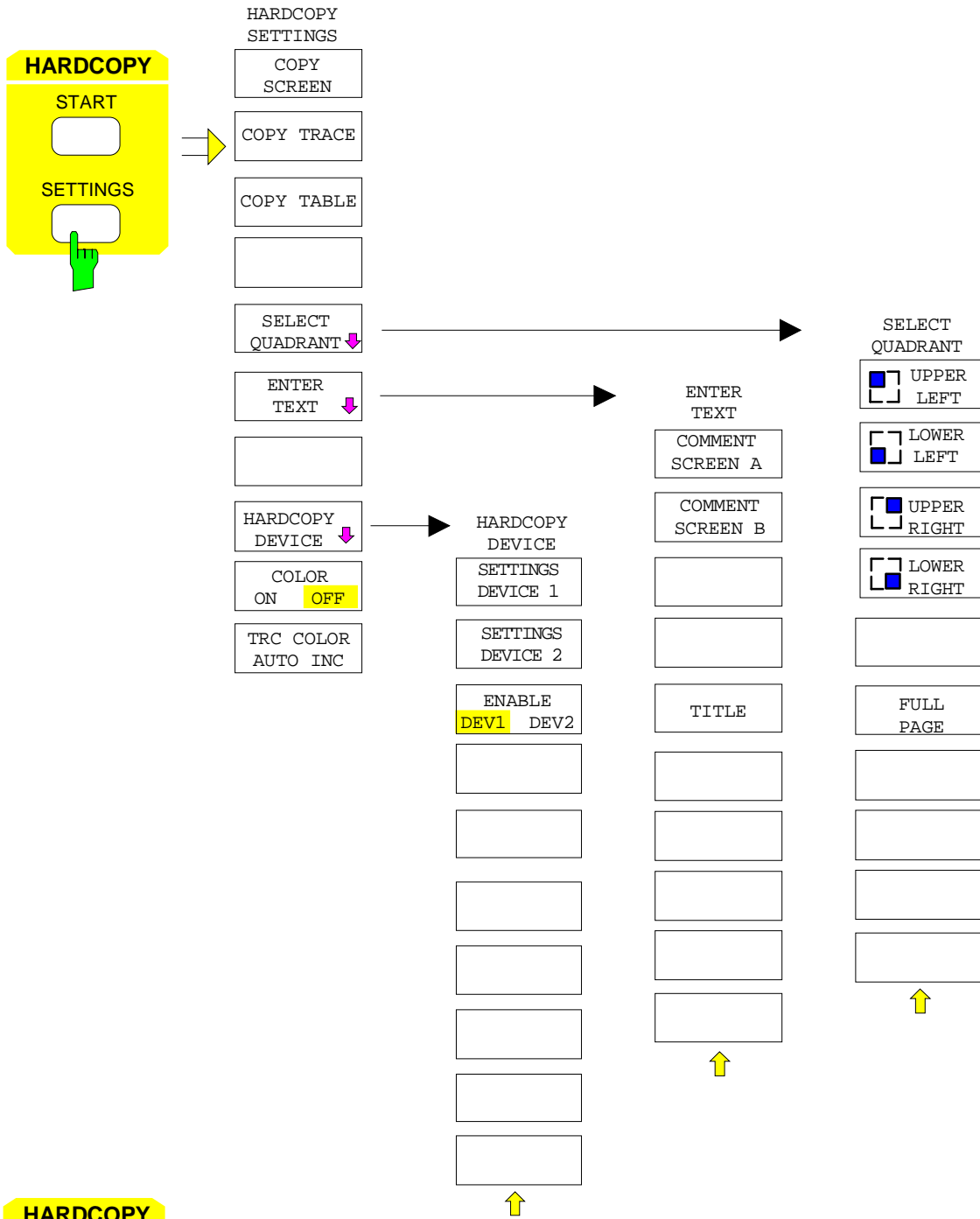

without softkey menu

Frequency Key Group

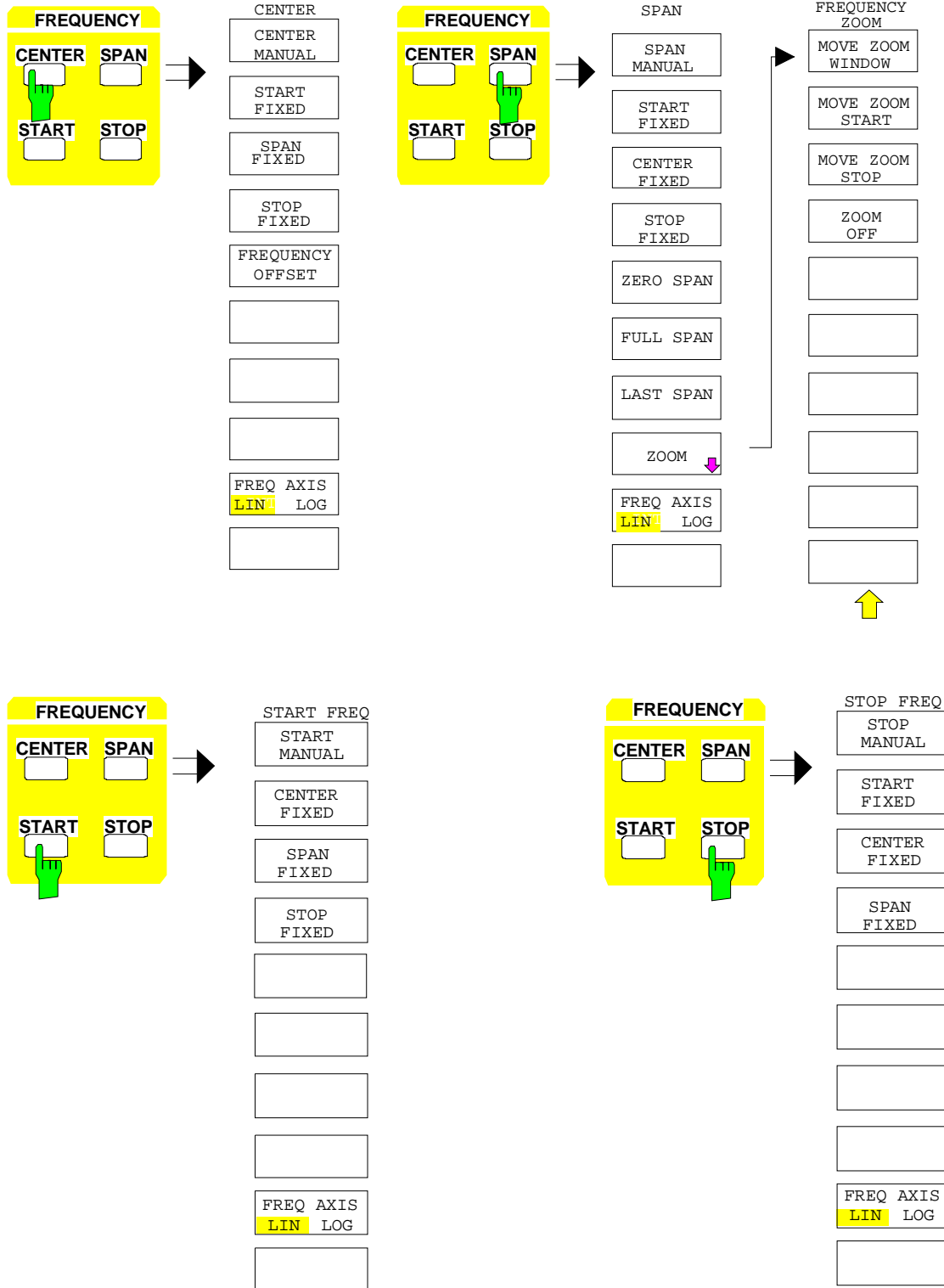

Level Key Group, Input Key

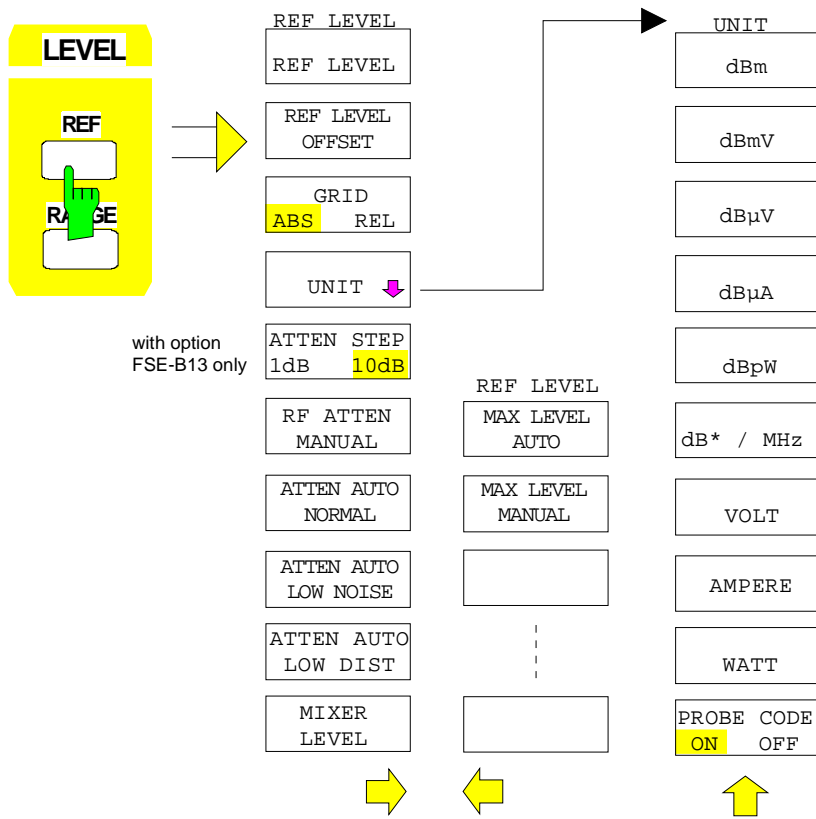

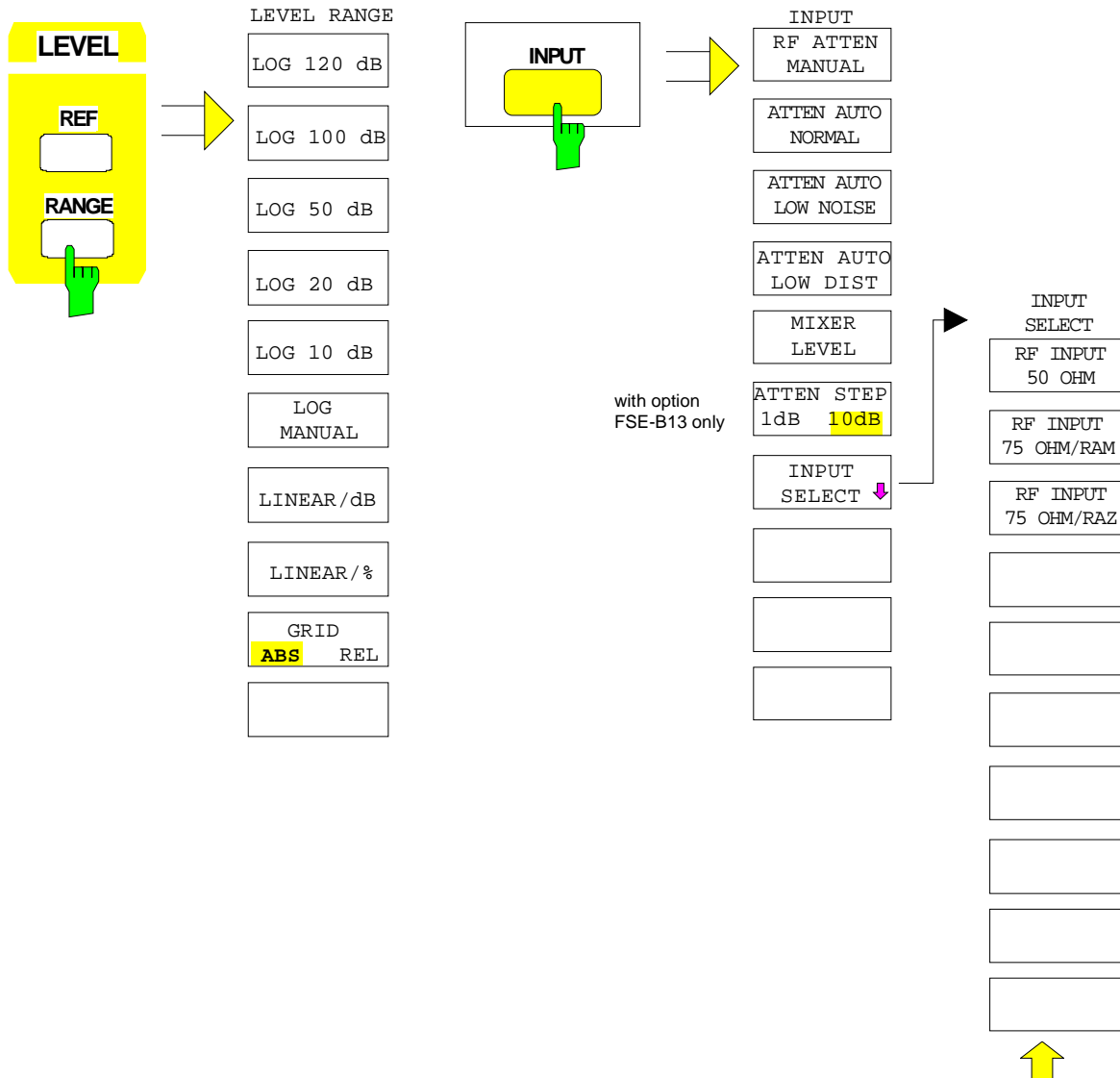

Marker Key Group

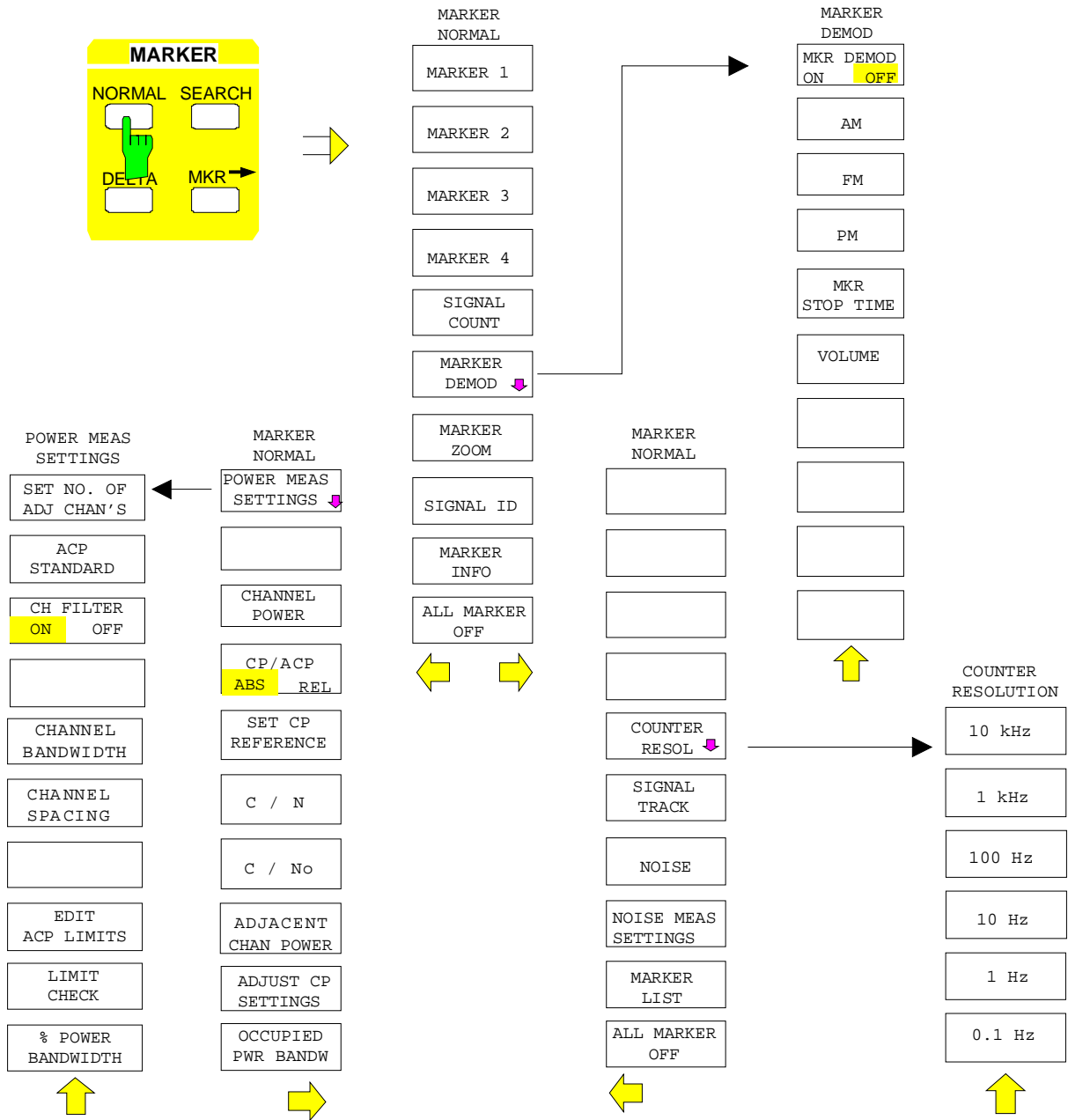

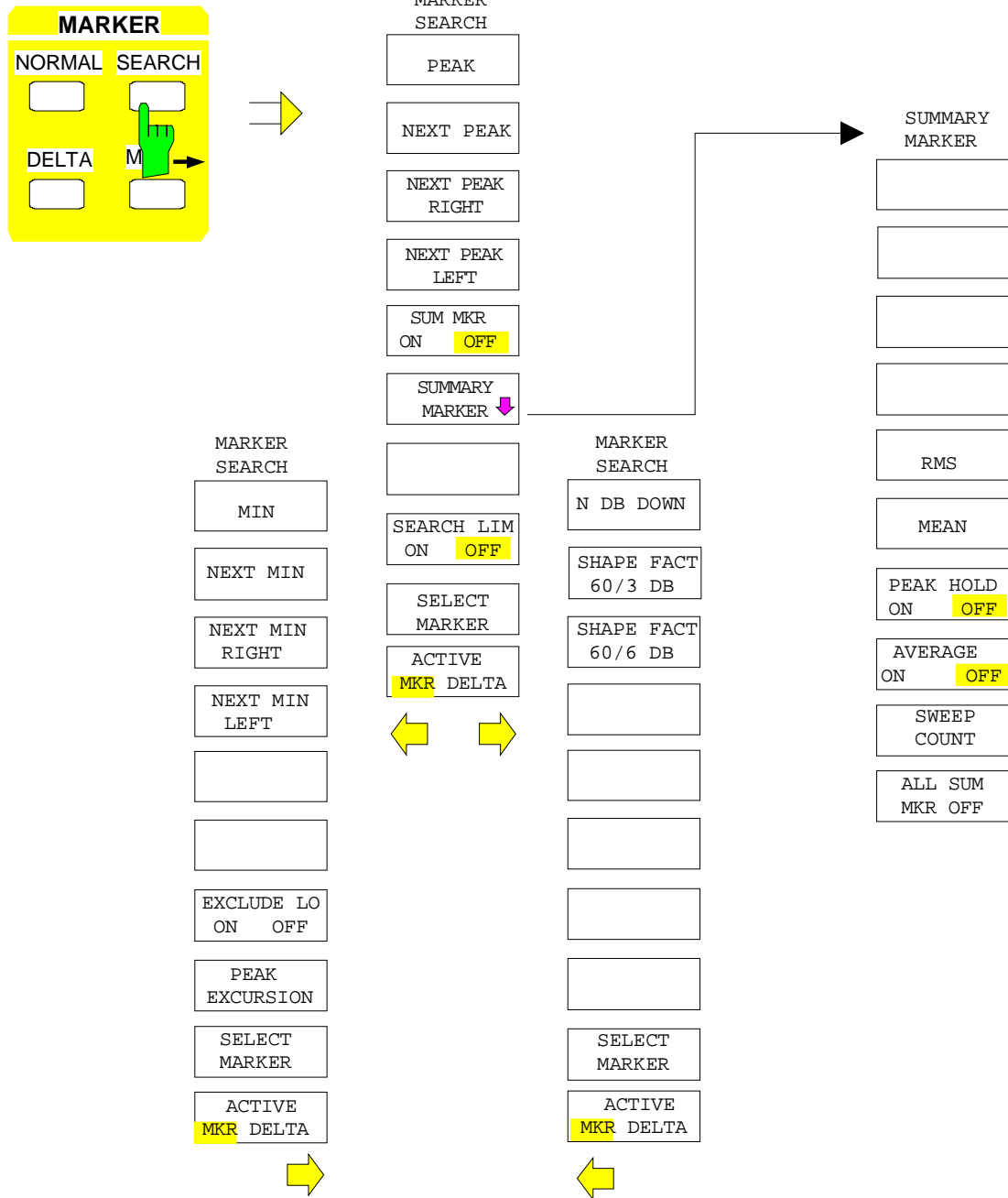

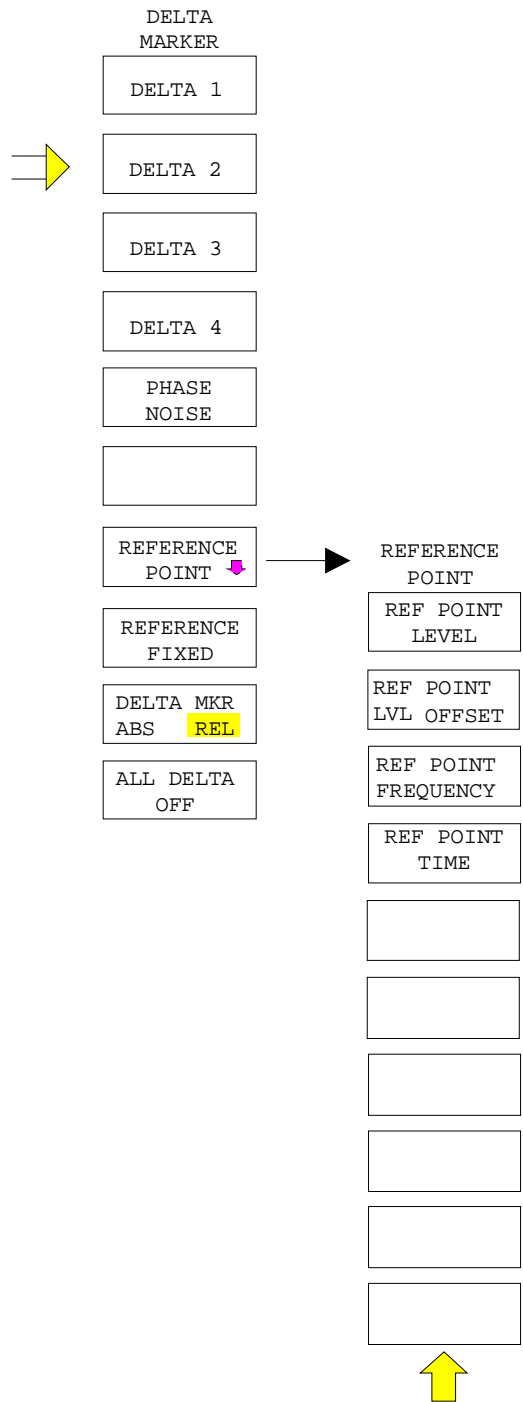
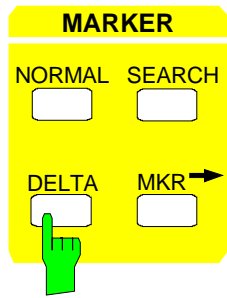

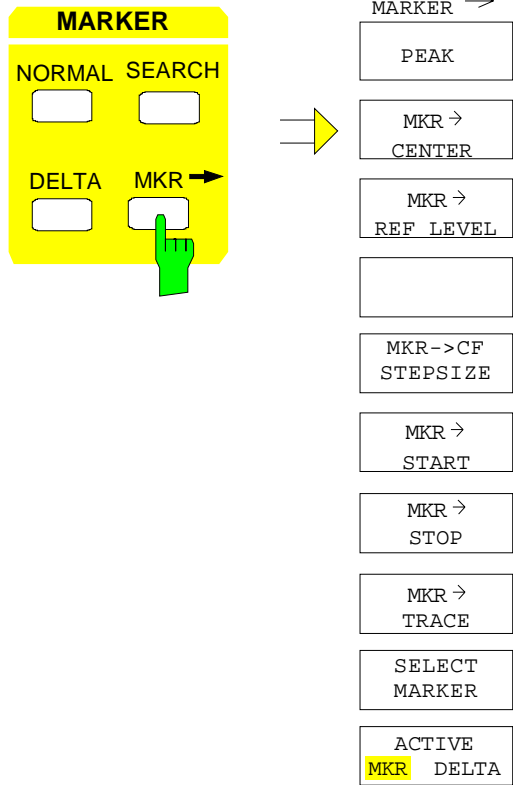

Lines Key Group

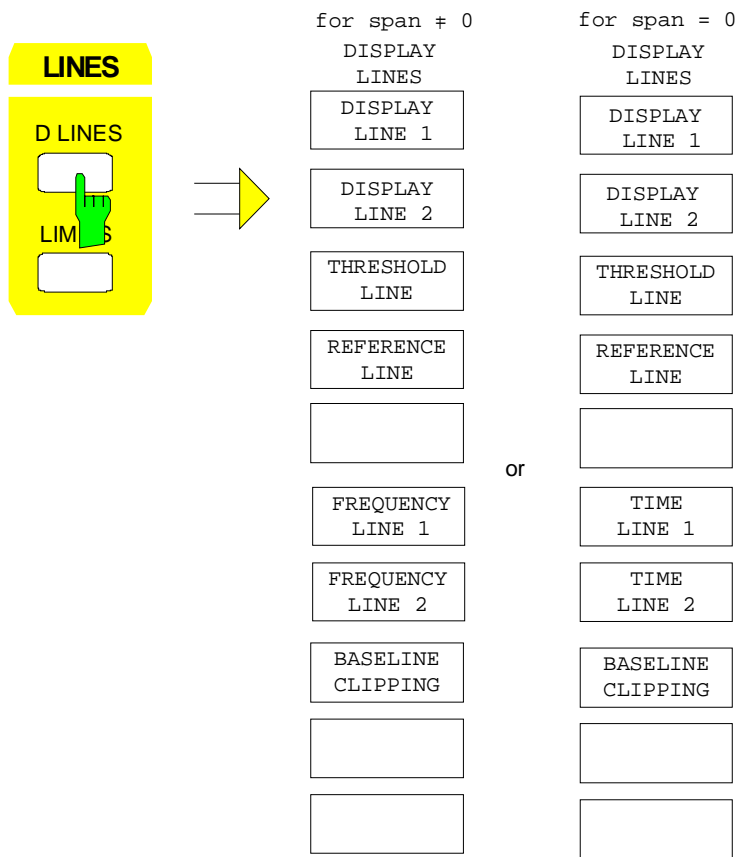

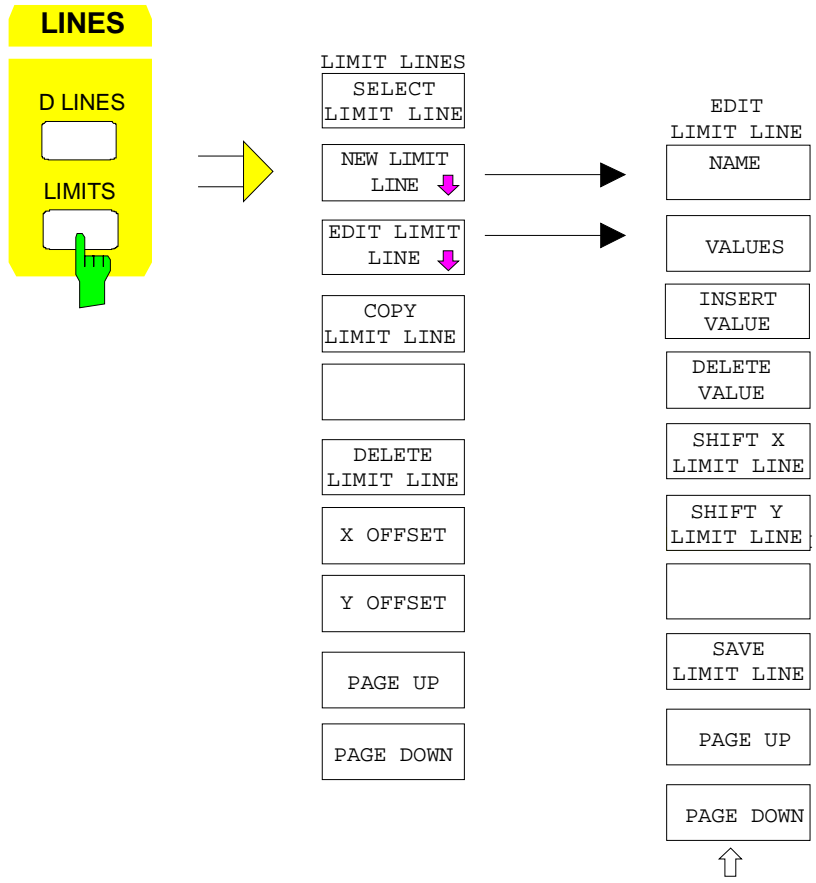

Trace Key Group

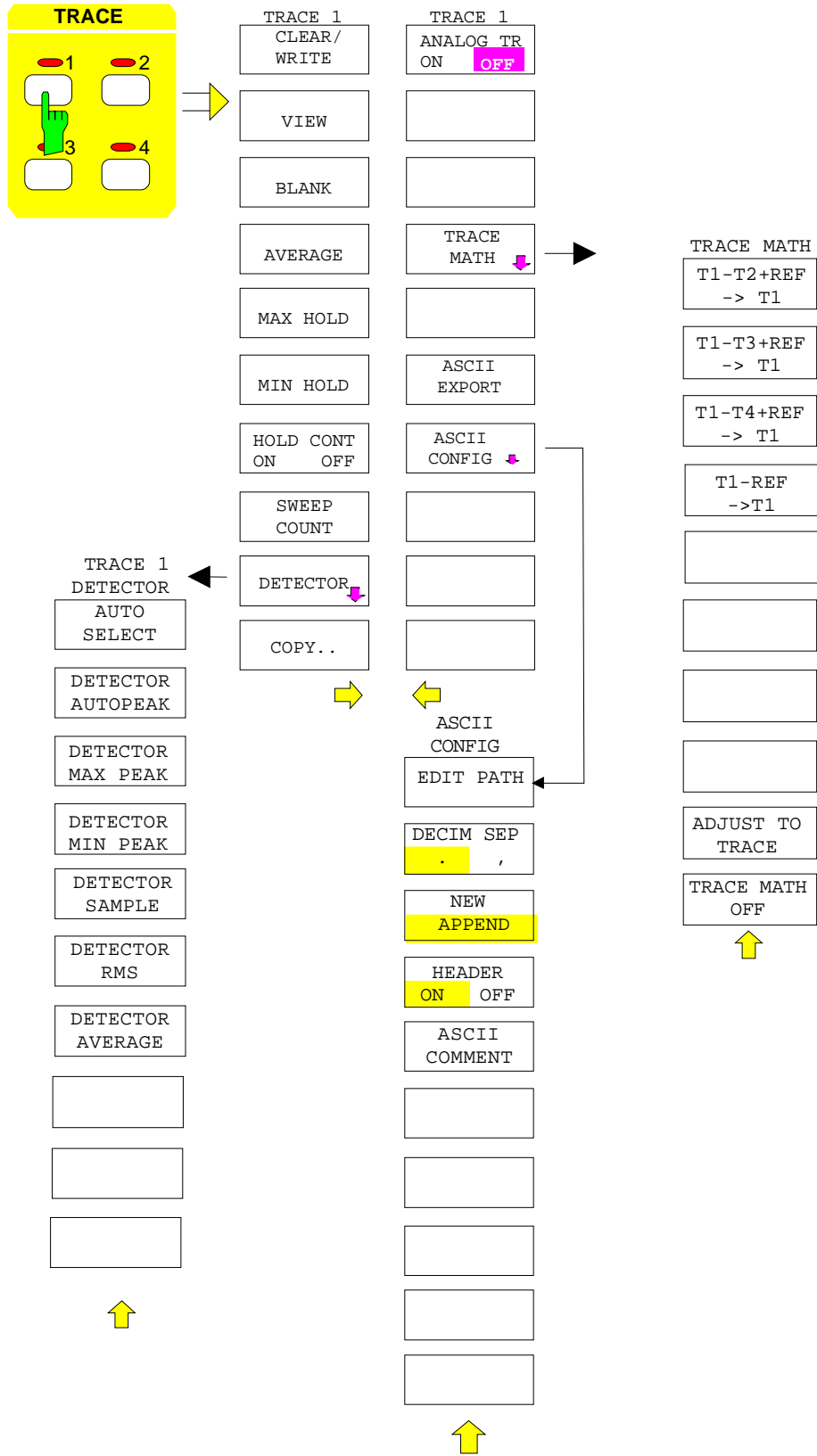

Sweep Key Group

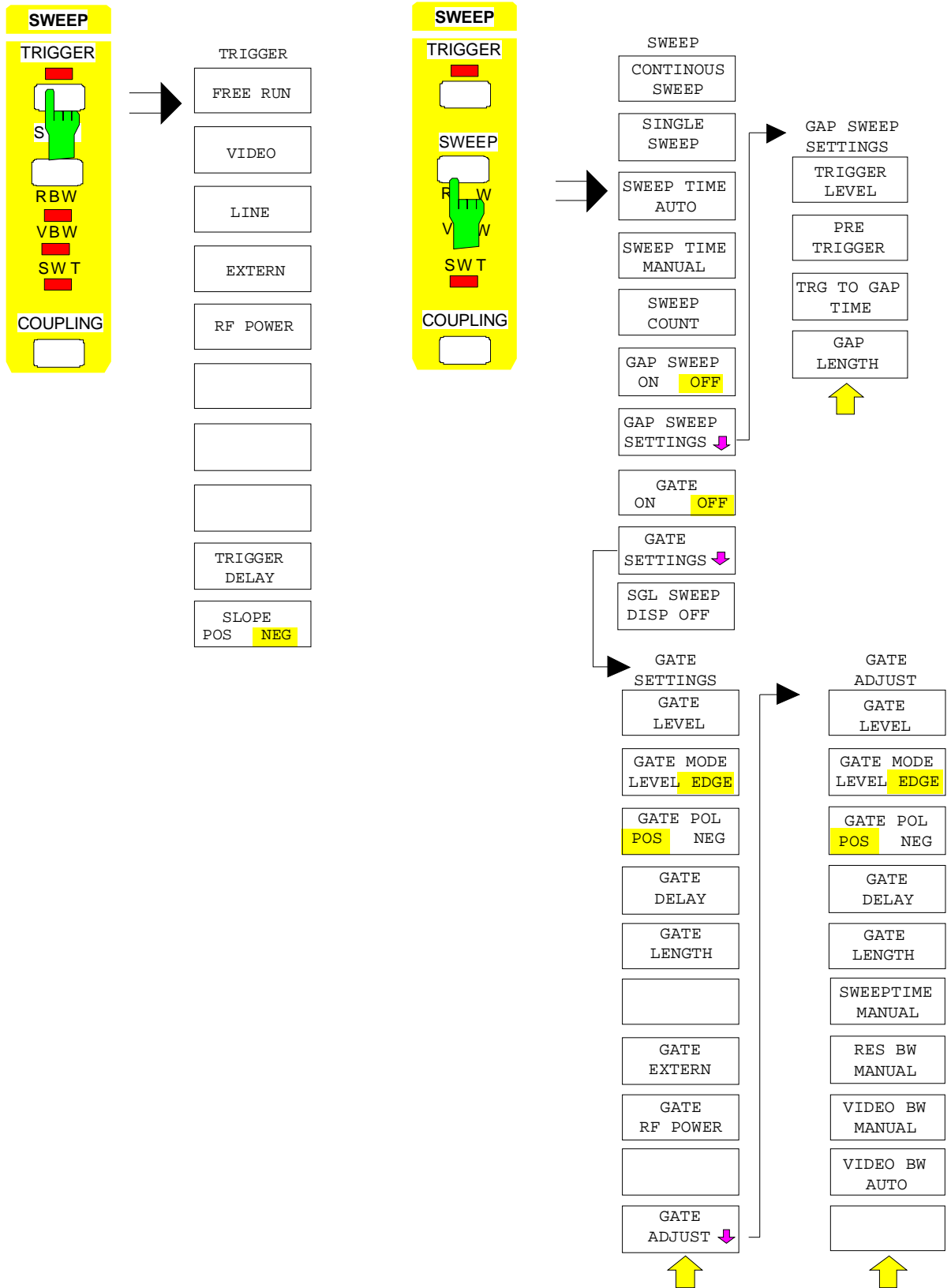

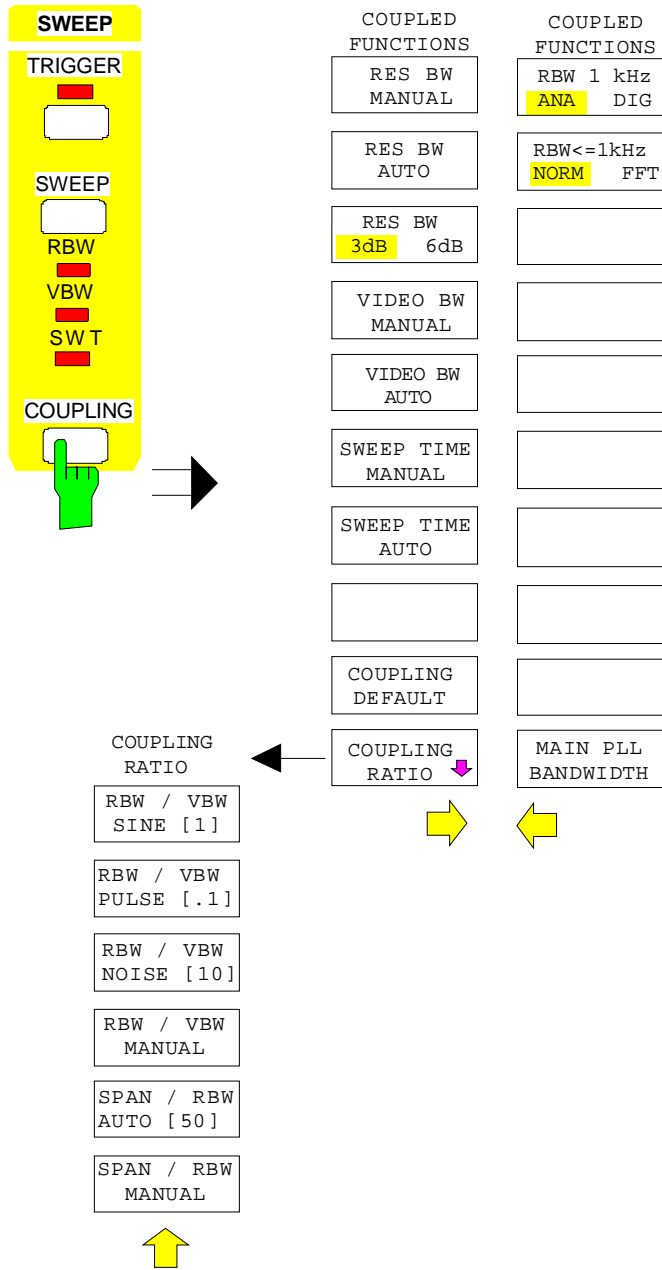

Memory Key Group

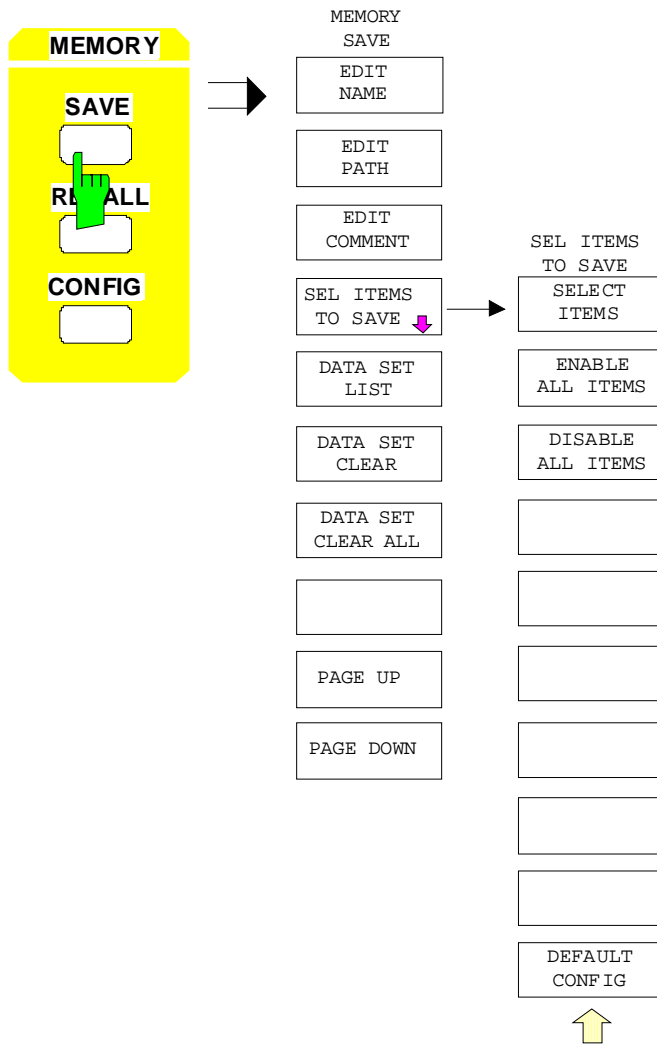

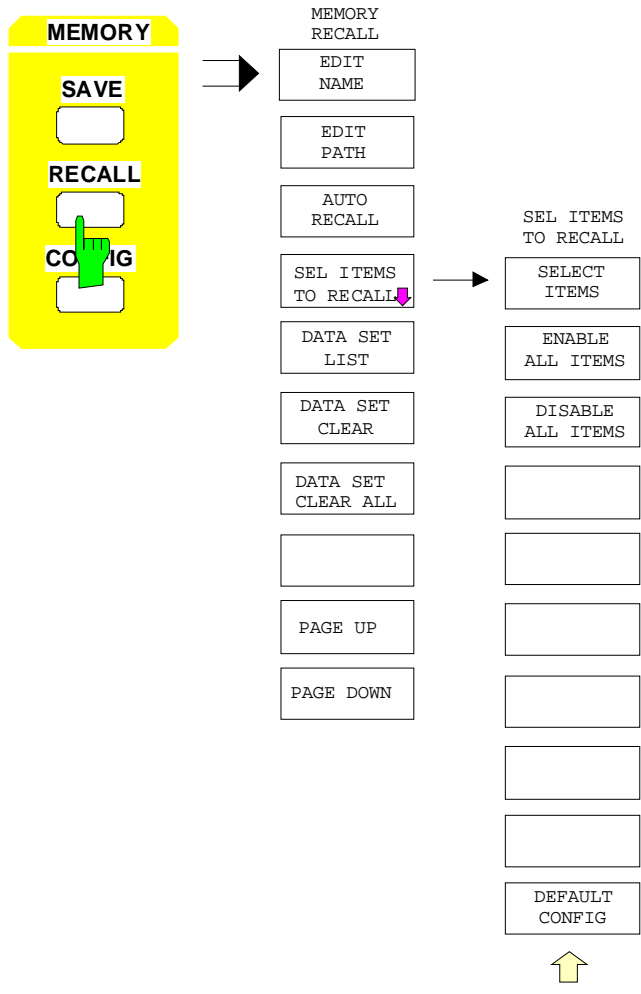

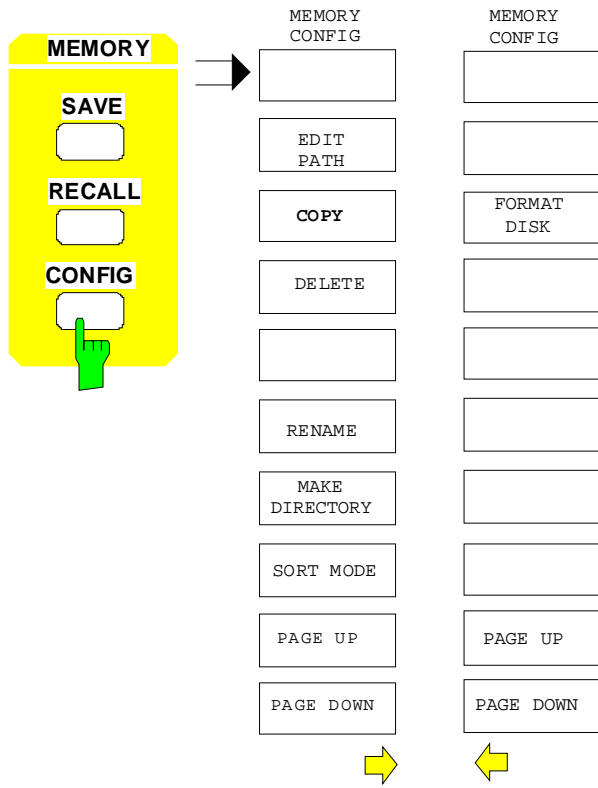

User Key Group

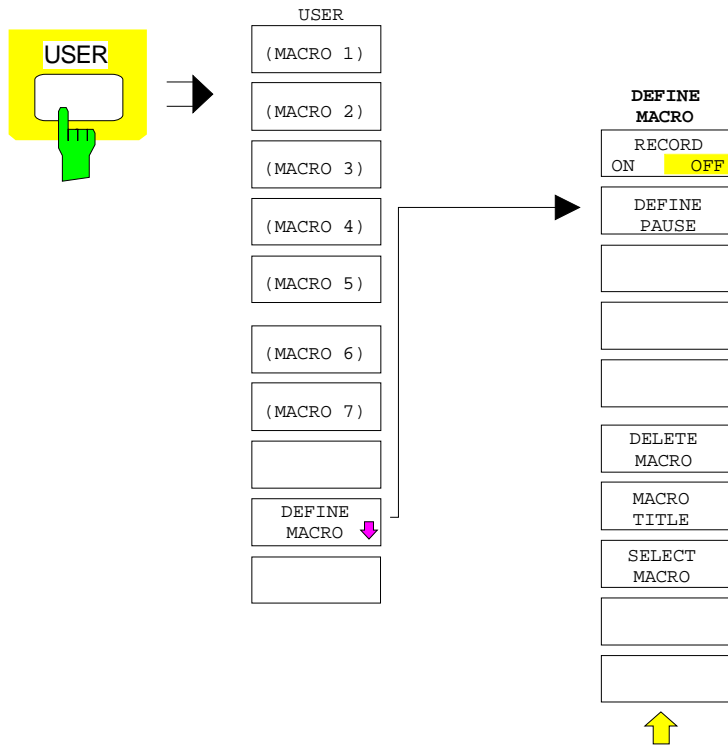

Contents - Chapter 4 "Instrument Functions"

| | |
|--|-------------|
| 4 Instrument Functions | 4.1 |
| General Configuration – SYSTEM and CONFIGURATION Key Groups | 4.2 |
| FSE Initial Configuration – PRESET Key..... | 4.2 |
| Display Configuration – DISPLAY Key..... | 4.3 |
| Display Screen Mode Selection..... | 4.4 |
| Measurement Window Coupling..... | 4.5 |
| Display Screen Configuration..... | 4.6 |
| Recording the Correction Data – CAL Key..... | 4.9 |
| Correction Function Calls..... | 4.10 |
| Results of System Error Correction..... | 4.12 |
| Instrument Status and Measurement Parameters – INFO Key..... | 4.13 |
| Firmware Versions..... | 4.13 |
| Hardware Configuration and Options..... | 4.14 |
| Self Test..... | 4.15 |
| System Messages..... | 4.16 |
| Statistics Function for Input Attenuator Switching..... | 4.17 |
| Mode Selection – MODE Key..... | 4.18 |
| Preliminary Setup and Interface Configuration – SETUP Key..... | 4.20 |
| Using Transducers..... | 4.20 |
| Activating Transducer Factors and Transducer Sets..... | 4.21 |
| New Entry and Editing of Transducer Factors..... | 4.23 |
| New Entry and Editing of Transducer Sets..... | 4.27 |
| Enabling Firmware Options..... | 4.31 |
| External Reference Oscillator..... | 4.31 |
| Service Functions..... | 4.32 |
| Setting the Interface Configuration and Time - with Windows NT Controller..... | 4.34 |
| IEC/IEEE-Bus Address Selection..... | 4.34 |
| User Port Configuration..... | 4.35 |
| Serial Interface Configuration..... | 4.36 |
| Setting the Date and Time..... | 4.39 |
| Connecting the External Monitor..... | 4.39 |
| Switching the Beeper ON/OFF..... | 4.39 |
| Setting the Interface Configuration and Time - without Controller Option or with MS DOS Controller..... | 4.40 |
| IEC Bus Address Selection..... | 4.40 |
| Switching the Beeper ON/OFF..... | 4.40 |
| User Port Configuration..... | 4.41 |
| Serial Interface Configuration..... | 4.42 |
| Setting Date and Time..... | 4.45 |
| Mouse Configuration..... | 4.46 |
| Firmware Update..... | 4.47 |
| Status Display-Remote/Manual Control – STATUS Key Group | 4.49 |
| Measurement Documentation – HARDCOPY Key Group | 4.50 |
| Printing Data – START Key - with Windows NT Controller..... | 4.50 |
| Printing Data – START Key- with MS DOS Controller or without Controller..... | 4.52 |

| | |
|--|-------------|
| Printing Configuration – <i>SETTINGS</i> Key | 4.54 |
| Selection of Displayed Elements and Colour Settings | 4.55 |
| Selection of Hardcopy Format..... | 4.56 |
| Entry of Comment Text | 4.57 |
| Selection and Configuration of the Printer - with Windows NT Controller | 4.58 |
| Selection and Configuration of the Printer - with DOS Controller/ without Controller.. | 4.60 |
| Saving and Recalling Data Sets – <i>MEMORY</i> Key Group..... | 4.66 |
| Configuration of Memory – <i>CONFIG</i> Key | 4.68 |
| Saving Data Sets – <i>SAVE</i> Key | 4.70 |
| Selecting the Data Set for Saving..... | 4.71 |
| Selecting the Data subset for Storage..... | 4.73 |
| Recalling of Data Sets – <i>RECALL</i> Key | 4.75 |
| Selecting the Data Set for Recalling..... | 4.76 |
| Building a Data Set..... | 4.78 |
| Macros – <i>USER</i> Key..... | 4.80 |
| Fundamentals..... | 4.80 |
| Starting Macros..... | 4.81 |
| Defining Macros..... | 4.82 |
| Analyzer Mode..... | 4.84 |
| Frequency and Span Selection – <i>FREQUENCY</i> Key Group | 4.84 |
| Start Frequency – <i>START</i> Key..... | 4.84 |
| Stop Frequency – <i>STOP</i> Key | 4.86 |
| Center Frequency – <i>CENTER</i> Key..... | 4.87 |
| Center Frequency Step Size | 4.89 |
| Frequency Span – <i>SPAN</i> Key | 4.91 |
| Display Zoom..... | 4.93 |
| Level Display and RF Input Configuration – <i>LEVEL</i> Key Group..... | 4.94 |
| Reference Level – <i>REF</i> key | 4.94 |
| Display Units..... | 4.96 |
| Level Range – <i>RANGE</i> Key | 4.98 |
| RF Input Configuration – <i>INPUT</i> Key | 4.100 |
| Option 1 dB Attenuator - FSE-B13 | 4.103 |
| Marker Functions – <i>MARKER</i> Key Group | 4.105 |
| Main Markers– <i>NORMAL</i> Key..... | 4.105 |
| LF Demodulation | 4.109 |
| Frequency Measurement..... | 4.111 |
| Noise Power Density Measurement | 4.112 |
| Channel Power Measurements | 4.113 |
| Marker Step Size | 4.127 |
| Delta Markers – <i>DELTA</i> Key | 4.128 |
| Phase Noise Measurement | 4.131 |
| Delta-Marker Step Size - <i>STEP</i> Key..... | 4.132 |
| Search Functions – <i>SEARCH</i> Key | 4.133 |
| Summary Marker | 4.138 |
| Instrument Parameter Changes via Markers – <i>MKR</i> → Key | 4.141 |
| Setup of Display and Limit Lines – <i>LINES</i> Key Field | 4.143 |
| Display Lines – <i>D LINES</i> Key..... | 4.143 |
| Limit Lines – <i>LIMITS</i> Key | 4.147 |
| Limit Line Selection | 4.148 |
| Entering and Editing of Limit Lines | 4.151 |

| | |
|--|--------------|
| Trace Selection and Setup – <i>TRACE</i> Key Group..... | 4.156 |
| Measurement Function Selection - <i>TRACE 1 to 4</i> key..... | 4.156 |
| Detector Selection | 4.161 |
| Quasi Analog Display | 4.165 |
| Mathematical Functions for Traces | 4.165 |
| Trace Export..... | 4.167 |
| Sweep Control – <i>SWEEP</i> Key Group..... | 4.170 |
| Coupled Settings – <i>COUPLING</i> Key | 4.170 |
| Setting and Coupling the Coupling Res., Video Bandw. and Sweep Time... 4.171 | |
| Sweep Coupling Ratio | 4.176 |
| Sweep Trigger – <i>TRIGGER</i> Key | 4.178 |
| Sweep Setup – <i>SWEEP</i> Key..... | 4.180 |
| Gated Sweep..... | 4.182 |
| Sweep Blanking – Gap Sweep | 4.188 |
| Tracking Generator Option | 4.192 |
| Tracking Generator Settings..... | 4.193 |
| Transmission Measurement..... | 4.194 |
| Calibration of the Transmission Measurement..... | 4.194 |
| Normalization..... | 4.196 |
| Reflection Measurements..... | 4.200 |
| Calibration of Reflection Measurement | 4.200 |
| Calibration Methods..... | 4.201 |
| Frequency-Converting Measurements | 4.202 |
| External Modulation of Tracking Generator..... | 4.203 |
| Option FSE-B3 –TV Demodulator | 4.206 |
| Configuration of the TV Demodulator..... | 4.206 |
| Triggering on TV Signals..... | 4.208 |

4 Instrument Functions

All functions of the spectrum analyzer are explained in detail in this chapter.

The instrument functions for general settings, printout and data management are described at the beginning of this chapter – key groups *SYSTEM*, *CONFIGURATION*, *HARDCOPY*, *MEMORY* and the *USER* key.

The sequence of the following key groups depends on their appearance on the front panel: key groups *FREQUENCY*, *LEVEL*, *MARKER*, *LINES*, *TRACE*, *SWEEP* and the *INPUT* key.

All options that provide an additional operating mode and are not supplied with a separate manual are described at the end of the chapter.

The various softkeys in a menu are described from top to bottom and from the left to the right side menu. The submenus are indicated by an indentation or displayed in a separate section. The whole path (key - softkey - ...) is indicated in the line above the menu display.

An overview of the menus is given in chapter 3 which also contains the description of the operating concept.

For fast reference a list of softkeys with the associated IEC/IEEE-bus commands is given at the end of Chapter 6.

An index at the end of the handbook provides as further help for the user.

General Configuration – *SYSTEM* and *CONFIGURATION* Key Groups

FSE Initial Configuration – *PRESET* Key

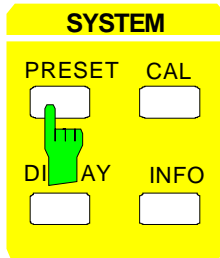

Using the *PRESET* key, the FSE can be brought to a predefined initial state equivalent to the state after power on. All previous settings are deleted if they were not previously saved in memory. Returning to the *PRESET* state is not critical with regard to an arbitrary signal which may still be present at the input as long as the signal is within the specified voltage range.

Note: *The initial state set by the PRESET key can be adapted to the user requirements using the AUTO RECALL function. When the PRESET key is pressed, the AUTO RECALL dataset is loaded. For further information refer to Section "Saving and Recalling Data Sets".*

IEC/IEEE- bus command : *RST

Pressing the *PRESET* key, causes the FSE to enter its initial state according to the following table:

Table 4-1 Initial state of the FSE

| Parameter | Setting | | | | |
|-----------------------------|------------|------------|------------|------------|----------------|
| | FSEA | FSEB | FSEM | FSEK | |
| Mode | analyzer | analyzer | analyzer | analyzer | |
| Center Frequency | 1,75 GHz | 3,5 GHz | 13,25 GHz | 20 GHz | |
| Center Frequency Step Width | 350 MHz | 700 MHz | 2,65 GHz | 4GHz | auto, 0.1xSpan |
| Span | 3,5 GHz | 7 GHz | 26,5 GHz | 40 GHz | |
| RF Attenuation | 10 dB | 10 dB | 10 dB | 10 dB | auto |
| Ref Level | -20 dBm | -20 dBm | -20 dBm | - 20 dBm | |
| Level Range | 100 dB log | 100 dB log | 100 dB log | 100 dB log | |
| Detector | auto peak | auto peak | auto peak | auto peak | |
| Sweep Time | 5 ms | 5 ms | 150 ms | 225 ms | auto |
| Res BW | 3 MHz | 3 MHz | 3 MHz | 3 MHz | auto |
| Video BW | 3 MHz | 3 MHz | 3 MHz | 3 MHz | auto |
| Sweep | cont | cont | cont | cont | |
| Trigger | free run | free run | free run | free run | |
| Trace | 1 | 1 | 1 | 1 | clr write |
| Trace | 2, 3, 4 | 2, 3, 4 | 2, 3, 4 | 2, 3, 4 | blink |

Display Configuration – DISPLAY Key

The measurement results are displayed on the screen of the FSE either in a full-screen window or in two split-screen windows. In some cases, the two windows can be subdivided into two diagrams each, e. g. for the representation of the inphase and quadrature signal in the vector analyzer mode (option FSE-B7).

If only one window is used, this window fills the complete display screen. Two measurement windows are always placed over each other. The axes labelling and measurement settings are defined independently in each measurement window.

When two measurement windows are used, the settings can be chosen to be either coupled or fully independent from each other. The measurement procedure is always sequential.

New instrument settings can only be entered in the active measurement window. This window is marked on the upper right corner of the grid. Coupled settings are changed simultaneously in both windows at the time of entry.

The entry of the measurement parameters for each of the two windows can be either independent from one another using numerical inputs, or by graphical definition of the span through the use of level and frequency lines. The former case, e.g., may be used for harmonic or frequency converter measurements, and the latter case, for a zoom display of a frequency or level segment.

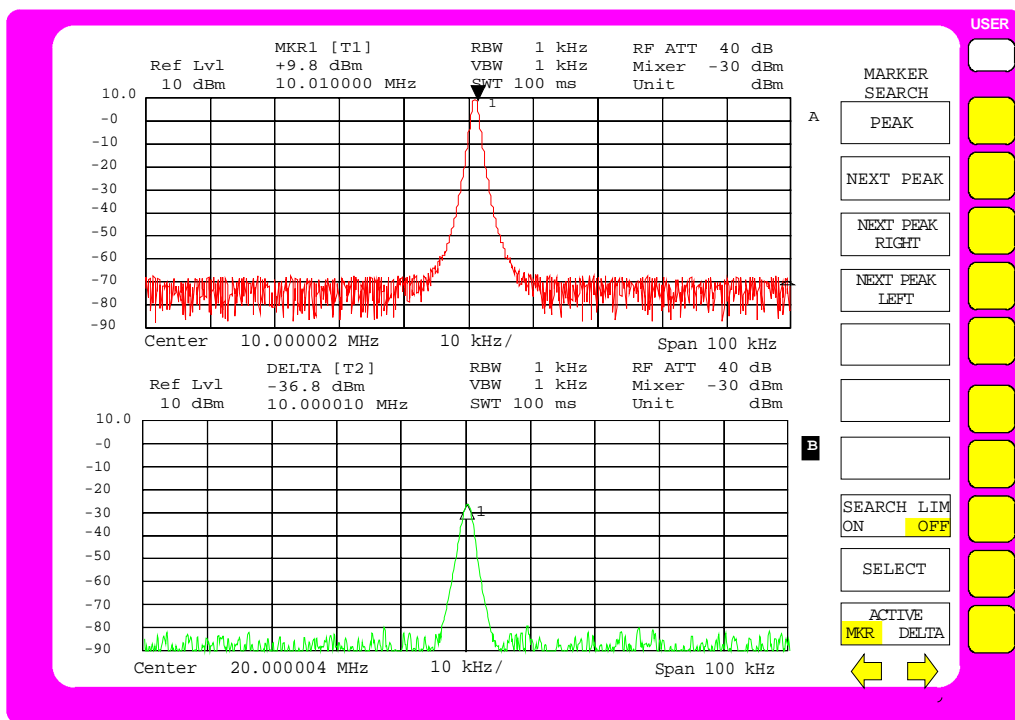
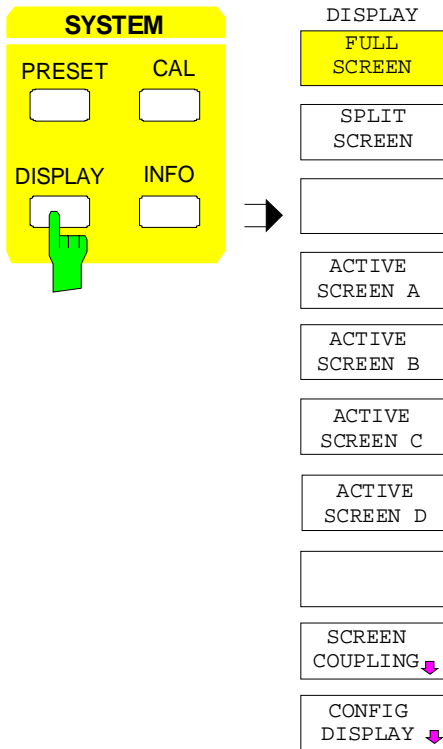

Fig. 4-1 Split screen mode, screens uncoupled

SYSTEM DISPLAY menu:



The *DISPLAY* key calls a menu which is used to configure the display screen and to select the active measurement window in *SPLIT-SCREEN* mode.

Display Screen Mode Selection

SYSTEM DISPLAY menu:

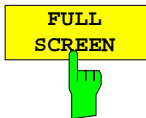

The *FULL SCREEN* softkey selects the full-screen display. This is the default setting of the FSE.

In this mode, the *ACTIVE SCREEN A* / *ACTIVE SCREEN B* and *SCREEN COUPLING* softkeys are not used.

IEC/IEEE- bus command :DISPlay:FORMat SINGLE

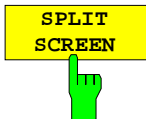

The *SPLIT SCREEN* softkey selects the split screen mode. The upper screen is designated *SCREEN A*, the lower screen *SCREEN B*.

IEC/IEEE- bus command :DISPlay:FORMat SPLit



If *SPLIT SCREEN* display is activated, the *ACTIVE SCREEN A* and *ACTIVE SCREEN B* softkeys activate either screen A or screen B.

The entry of new settings is only possible for the active window.

When switching back to *FULL SCREEN* mode, the active measurement window is displayed.

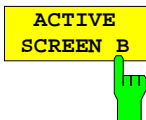

If, in addition, the two screens are both subdivided into two diagrams, the *ACTIVE SCREEN A/B* softkeys activate the upper diagram, *ACTIVE SCREEN C/D* the lower diagram in each screen.

IEC/IEEE- bus command - (the screen is selected via the numeric suffix)

Measurement Window Coupling

For the most part, the settings for the two windows can be either independently performed or coupled to one another. In many cases, when changes are made in one window (e.g., the reference level) it is desirable to also make the corresponding changes in the second window. The measurement window parameters which are to be coupled may be selected in the *SCREEN COUPLING* menu.

SYSTEM DISPLAY-SCREEN COUPLING submenu:

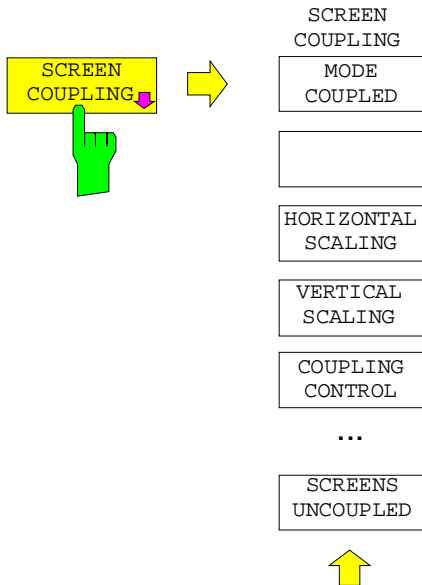

The *SCREEN COUPLING* softkey calls a sub-menu in which the coupling between the two measurement windows *SCREEN A* and *SCREEN B* can be defined. This coupling is only effective when both windows are displayed (*SPLIT SCREEN*).

In the default setting, all of the items which are selectable are also coupled.

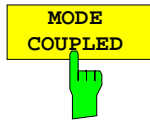

The *MODE COUPLED* softkey switches the coupling of the operating mode (Analyzer, Vector Analyzer) on/off.

IEC/IEEE- bus command : `INSTRument<1|2>:COUPlE MODE`



The *HORIZONTAL SCALING* softkey switches the coupled scaling of the horizontal axes on and off. In the frequency domain, the center frequency and the frequency span are identical. In the time domain, the sweep time for both windows is the same.

IEC/IEEE- bus command : `INSTRument<1|2>:COUPlE X`



The *VERTICAL SCALING* softkey switches the coupled scaling of the vertical axes on and off. For a level measurement, this means that the reference level and the vertical resolution (*LEVEL RANGE*) are set to the same values in both windows.

IEC/IEEE- bus command : `INSTRument<1|2>:COUPlE Y`

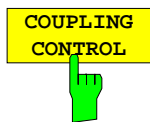

The *COUPLING CONTROL* softkey switches the coupling of the trigger and gate parameters and of *SWEEP COUNT* and *SWEEP SINGLE/CONTINUOUS* on/off.

IEC/IEEE- bus command : `INSTRument<1|2>:COUPlE CONTrol`

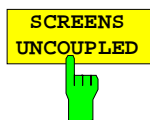

The *SCREENS UNCOUPLED* softkey switches all of the possible couplings between the measurement windows to off.

IEC/IEEE- bus command : `INSTRument<1|2>:COUPlE NONE | ALL`

Display Screen Configuration

SYSTEM DISPLAY-CONFIG DISPLAY submenu:

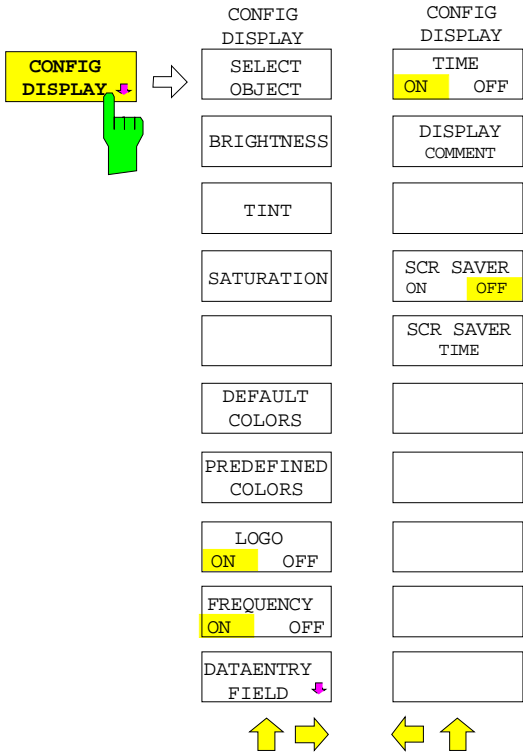

The *CONFIG DISPLAY* softkey calls a submenu, in which the selection of color and brightness for the individual elements on the display screen takes place. The actual selection of the elements takes place in the corresponding menu table.

The color assignment of the softkeys is coupled with the color assignment of other display elements.

Changing for example the color of *SOFTKEY STATE OFF* causes the color of the table background to be changed at the same time. The same applies to *SOFTKEY STATE DATA ENTRY* and display lines, and to *SOFTKEY STATE ON* and enhancement labels.

In the right side menu, date, time and a diagram label can be displayed on the screen and the energy saving mode can be activated.

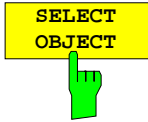

The *SELECT OBJECT* softkey activates the *SELECT DISPLAY OBJECT* table, with which a graphics element can be selected. After selection, the brightness, tint and saturation of the selected element can be changed using the softkeys of the same name. The color changes can be seen immediately on the display screen.

| SELECT DISPLAY OBJECT | |
|-----------------------|--------------------------|
| ✓ | TRACE 1 |
| | TRACE 2 |
| | TRACE 3 |
| | TRACE 4 |
| | MARKER |
| | GRID |
| | SOFTKEY STATE ON |
| | SOFTKEY STATE DATA ENTRY |
| | SOFTKEY STATE OFF |
| | SOFTKEY SHADE |
| | TEXT |
| | TITLE |
| | BACKGROUND |



The *BRIGHTNESS* softkey is used to enter the brightness of the color for the selected element. The range of input values is 0 to 100%.

IEC/IEEE- bus command :DISPlay:CMAP:HSL <hue>,<sat>,<lum>

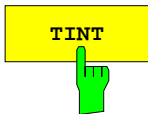

The *TINT* softkey is used to enter the color tint of the selected element. The percentage that is entered specifies a point in a color spectrum ranging from red (0%) to blue (100%).

The *TINT* function is not available for monochrome (black/white) displays.

IEC/IEEE- bus command :DISPlay:CMAP:HSL <hue>,<sat>,<lum>



The *SATURATION* softkey is used to enter the color saturation of the selected element.
The range is 0 to 100%.

IEC/IEEE- bus command :DISPlay:CMAP:HSL <hue>,<sat>,<lum>

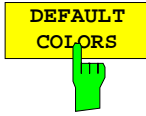

The *DEFAULT COLORS* softkey restores the default settings for brightness, color tint and color saturation for all display screen elements.

IEC/IEEE- bus command :DISPlay:CMAP<1...13>:DEFault



The *PREDEFINED COLORS* softkey activates a table, to select the predefined colors for the display screen elements can be selected.

IEC/IEEE- bus command :DISPlay:CMAP<1...13>:PDEFined BLACK

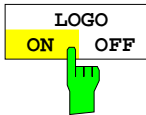

The *LOGO* softkey switches the Rohde & Schwarz company logo displayed in the upper left corner of the display screen on or off.

IEC/IEEE- bus command :DISPlay:LOGO ON | OFF

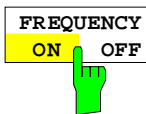

The *FREQUENCY* softkey switches the frequency information on the screen on and off. The softkey is available only in analyzer mode.

ON Frequency information is displayed.

OFF Frequency information is not output to the display. This can be used for example to protect confidential data.

IEC/IEEE- bus command :DISPlay:ANNOtation:FREQuency ON|OFF

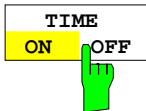

The *TIME* softkey switches on or off the date and time display at the lower edge of the diagram.

IEC/IEEE- bus command :DISPlay[:WINDow<1|2>]:TIME ON | OFF

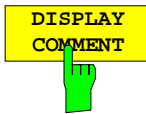

The *DISPLAY COMMENT* softkey activates the entry of a label comprising a maximum of 50 characters. This label is displayed at the lower edge of the diagram.

Pressing the softkey again causes the label to be switched off. The stored text, however, is not deleted.

IEC/IEEE- bus command
:DISPlay[:WINDow<1|2>]:TEXT[:DATA] <string>
:DISPlay[:WINDow<1|2>]:TEXT:STATE ON | OFF

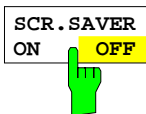

The *SCR. SAVER* softkey is used to switch the energy saving mode for the display on/off.

After the elapse of the shutdown time (*SCR. SAVER TIME*) the display is completely switched off, ie including backlighting.

The screen saver is deactivated by pressing any key or by sending the corresponding IEC/IEEE- bus command.

IEC/IEEE- bus command :DISPlay:PSAVer[:STATE] ON | OFF

Note: *If, with option FSE-B15, MS DOS Controller, switchover is made to the screen of the controller function using the ALT SYSREQ key, the screen saver is deactivated.*



The *SCR. SAVER TIME* softkey activates the entry of the time for the screen saver to respond. The shut-down time is entered in minutes between 1 to 100 minutes.

IEC/IEEE- bus command :DISPlay:PSAVer:HOLDoff <num_value>

SYSTEM DISPLAY-CONFIG DISPLAY DATAENTRY FIELD Untermenü:

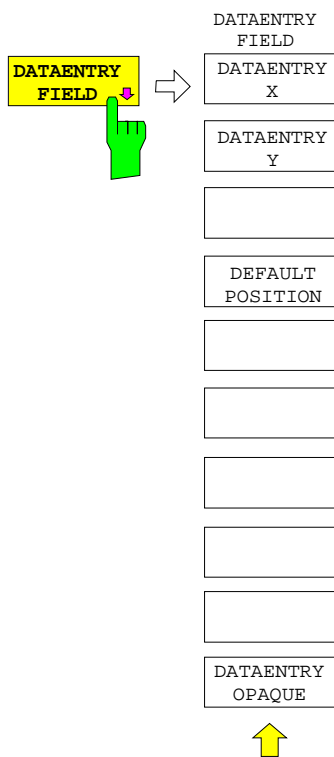

The *DATAENTRY FIELD* softkey displays a submenu used to specify the position and characteristics of the data entry field.

IEC/IEEE- bus command --

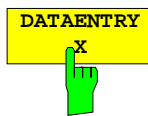

The *DATAENTRY X* softkey shifts the position of the data entry field horizontally.

IEC/IEEE- bus command --

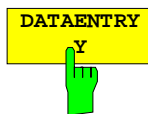

The *DATAENTRY Y* softkey shifts the position of the data entry field vertically.

IEC/IEEE- bus command --

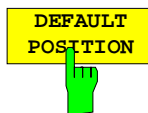

The *DEFAULT POSITION* softkey positions the data entry field automatically. In general, its position is the upper left edge of the grid on the active screen.

IEC/IEEE- bus command --



The *DATAENTRY OPAQUE* softkey sets the data entry windows to opaque. This means that entry windows are underlayed with the background color for tables and that diagrams and traces behind an entry window can no longer be seen.

IEC/IEEE- bus command --

Recording the Correction Data – CAL Key

The FSE maintains its high measurement accuracy thanks to its integrated system-error correction method. The CAL hard key provides a series of correction functions which allow not only the system error correction of the complete instrument, but also correction functions which are specifically applicable to the measurement requirements of relevant instrument sections.

The measurement settings of the FSE are saved and, after system error correction, completely restored. The correction data valid before system error correction are saved and, in case of a correction abort, restored.

A window shows the progress of the correction data recording. ABORT can be used to abort the procedure at any time.

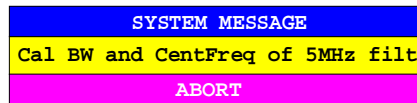

Note: The term "Calibration" formerly used for integrated system error correction was often taken to be the "true" calibration of the instrument performed during production and service. It is, therefore, no longer used although it appears in abbreviated form in the name of keys ("CAL...").

SYSTEM CAL menu:

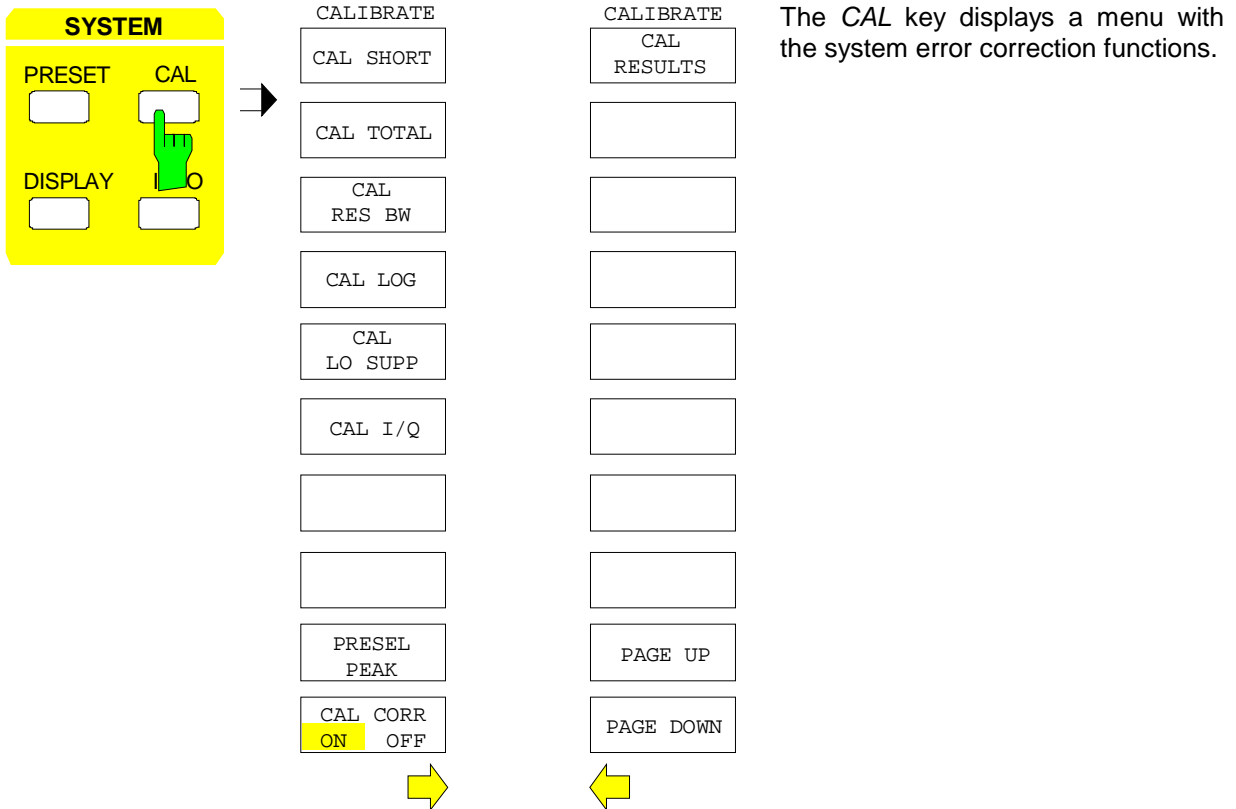

Correction Function Calls

SYSTEM CAL menu:



The *CAL SHORT* softkey starts a short calibration, in which the absolute gain of the analyzer as well as the gain errors of the selected bandwidth are corrected.

IEC/IEEE- bus command :CALibration:SHORT?

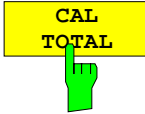

The *CAL TOTAL* softkey starts a complete correction of the analyzer including additional partial corrections shown in the menu.

UNCAL is displayed in the status line if the correction data recording has failed or if the correction values are deactivated (*CAL CORR* softkey= *OFF*).

IEC/IEEE- bus command :CALibration[:ALL]?



The *CAL RES BW* softkey starts the correction of the center frequency, the bandwidth and the gain of the resolution filter.

IEC/IEEE- bus command :CALibration:BANDwidth[:RESolution]?



The *CAL LOG* softkey starts the correction of the linearity of the logarithmic amplifier.

IEC/IEEE- bus command :CALibration:LDETEctor?



The *CAL LO SUPP* softkey starts the correction of the compensation of the first oscillator at low frequencies. After correction, the display of the internal oscillator at the frequency 0 Hz is very small.

It is recommended that the correction be performed whenever sensitive measurements are to be made at low frequencies.

The softkey is only available on model 30 of FSE.

IEC/IEEE- bus command ::CALibration:LOSuppression?

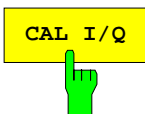

The *CAL I/Q* softkey starts the correction of the gain error of the I/Q demodulator.

The softkey is only available in conjunction with option FSE-B7.

IEC/IEEE- bus command :CALibration:IQ?

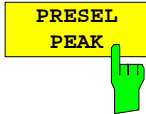

The *PRESEL PEAK* softkey optimizes the tuning of the preselector for input signals in the frequency range above 7 GHz.

This calibration should be used whenever signal levels in the frequency range above 7 GHz are to be measured and high accuracy is desired.

If a marker is not active when the *PRESEL PEAK* softkey is pressed, marker 1 is activated as the reference marker and placed on the signal maximum in the active trace. Otherwise the active marker is used.

The following window is displayed on the screen while the peaking function is running. The function can be aborted at any time using the *ABORT* line. In this case, the correction value determined at the factory is restored.

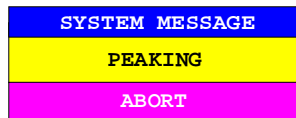

The input signal's signal-to-noise ratio must be at least 10dB in order that the peaking function runs properly. Otherwise, the preselector may be set incorrectly, which would cause level errors by subsequent measurements.

If the instrument setting (start/stop frequency, sweep time) is changed after *PRESEL PEAK* has been called, the correction value for the preselector determined by the function is no longer used. Instead, the correction value determined at the factory is restored.

The softkey is only available by those FSE models which have an input frequency range above 7 GHz.

IEC/IEEE- bus command :CALibration:PPEak?

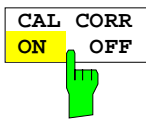

The *CAL CORR ON/OFF* softkey switches the correction data on/off.

ON The status message depends upon the results of the total correction

OFF The message *UNCAL* appears in the FSE status line.

IEC/IEEE- bus command :CALibration:STATE ON | OFF

Results of System Error Correction

SYSTEM CAL menu:



The *CAL RESULTS* softkey in the right-hand supplementary menu calls the *CALIBRATION RESULTS* table, which displays the correction data that has been recorded.

The *CALIBRATION RESULTS* table contains the following information:
page 1:

- date and time of the last recorded correction values
- overall results of the correction value recording
- list of the correction procedures according to function/module, including the correction values, the measured results and the individual results for each of the correction procedures

The results for the individual correction procedures are categorised and displayed as follows:

PASSED system error correction was completely successful
 CHECK deviations larger than expected, however, corrections could be performed
 FAILED deviations too large, no corrections were possible
 ABORTED correction aborted

| CALIBRATION RESULTS | | | | |
|--------------------------------------|--------------|---------|--------|--|
| CALIBRATION: PASSED | | | | |
| Last cal total: 05.Jun 1997 16:24:54 | | | | |
| Calibration of IF Filters PASSED | | | | |
| IF GAIN Adjust PASSED | | | | |
| Bandwidth: | | | | |
| Filter | Cal Val [Hz] | DAC Val | State | |
| 1kHz | 2.806e+01 | 1679 | PASSED | |
| 2kHz | 1.603e+01 | 2887 | PASSED | |
| 3kHz | -6.012e+00 | 3238 | PASSED | |
| 5kHz | -1.002e+01 | 3514 | PASSED | |
| 10kHz | 1.804e+02 | 3703 | PASSED | |
| 20kHz | 3.607e+02 | 3801 | PASSED | |
| 30kHz | 8.417e+02 | 3831 | PASSED | |
| 50kHz | 1.403e+03 | 3743 | PASSED | |
| 100kHz | 1.804e+03 | 3698 | PASSED | |
| 200kHz | 3.607e+03 | 3606 | PASSED | |
| 300kHz | 8.417e+03 | 3516 | PASSED | |
| 500kHz | 1.403e+04 | 3329 | PASSED | |
| 1MHz | 2.806e+04 | 2881 | PASSED | |

IEC/IEEE- bus command --

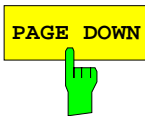

The *PAGE UP* and *PAGE DOWN* softkeys can be used to page through the table of correction results.

Instrument Status and Measurement Parameters – INFO Key

SYSTEM INFO menu:

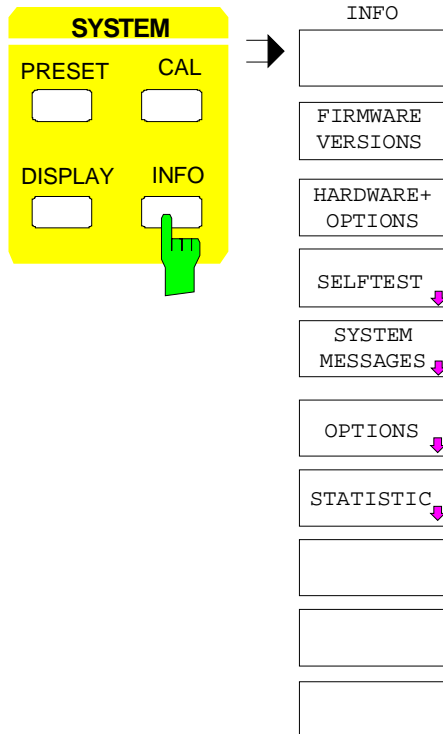

The *INFO* key is used to request general information concerning the instrument. These include:

- firmware version
- installed hardware and hardware options
- modification level of the individual modules
- self-test results with the option of calling self-test functions
- list of generated system messages
- installed firmware and hardware options.
- Statistical evaluations

Firmware Versions

SYSTEM INFO menu:



The *FIRMWARE VERSIONS* softkey opens two tables, which provide the following informations:

- Table *MODEL* displays the exact instrument model.

| MODEL |
|---------|
| FSEA 30 |

- In the *FIRMWARE VERSION* table, the version of each software component installed in the instrument is listed. The versions of programmable logic devices are also included if the firmware version of the device can be determined.

| FIRMWARE VERSION | |
|------------------|------------|
| BIOS | 1.2 |
| ANALYZER | 1.80 |
| SERIAL NUMBER | 101379/005 |

IEC/IEEE- bus command : *IDN?

Hardware Configuration and Options

SYSTEM INFO menu:

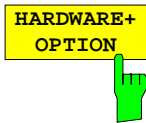

The *HARDWARE+OPTIONS* softkey opens two tables in which the modules (INSTALLED COMPONENTS) installed in the instrument are listed.

- Table *MODEL* lists the instrument name and model:

| MODEL |
|---------|
| FSEA 30 |

- Table *INSTALLED COMPONENTS* consists of four columns:

COMPONENT name of module

MODEL INDEX model number of the module

MODIF INDEX main modification index of the module

HW CODE secondary modification index of the module

These lists contain only the modules which are actually present in the instrument, i.e., the modules which were identified by the module recognition software.

| INSTALLED COMPONENTS | | | |
|----------------------|-------------|-------------|---------|
| COMPONENT | MODEL INDEX | MODIF INDEX | HW CODE |
| Main Processor | 4 | n/a | 0 |
| Graphic Board | 4 | n/a | 0 |
| I/O Board | 4 | n/a | 0 |
| FRAC SYN | 4 | 0 | 4 |
| RF Module | 4 | 0 | 4 |
| 2nd IF Converter | 3 | 2 | 2 |
| Detector | 4 | 0 | 2 |
| IF Filter | 3 | 2 | 3 |
| Digital IF | 2 | 0 | 2 |

IEC/IEEE- bus command *OPT?
:SYSTem:BINFo?

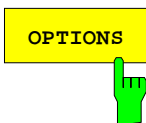

The *OPTIONS* softkey opens two tables listing the options installed.

| FIRMWARE OPTIONS | | |
|------------------|------|------------|
| DESIGNATION | TYPE | CODE |
| FFT | B5 | 1938496289 |

Note: New firmware options can be enabled in the *SETUP* menu.

| HARDWARE OPTIONS | |
|------------------------|------|
| DESIGNATION | CODE |
| Low Phase Noise & OCXO | B4 |
| Vector Signal Analysis | B7 |

IEC/IEEE- bus command *OPT?

Self Test

SYSTEM INFO-SELFTEST submenu:

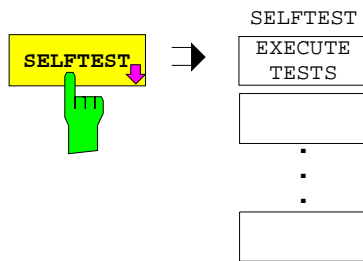

The *SELFTEST* softkey opens a submenu with which the self test can be started.

The instrument has extensive self test functions which comprehensively test instrument functionality. In case of a fault, the instrument can locate a defective module on its own. The self test sequence is described in more detail in the service manual instrument (supplied with the FSE).



The *EXECUTE TESTS* softkey starts the test of the complete instrument. During the self test a window is displayed:

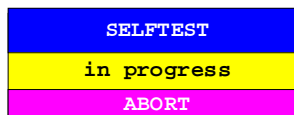

The functions are tested in the following order:

1. Modules main CPU, digital motherboard, graphics and the interfaces
2. Reference frequency conditioning, the synthesizer modules and all LO signals
3. All RF, IF and signal-weighting modules

If no failure occurs during the execution of the self test, the following message is displayed when the complete self test is finished:

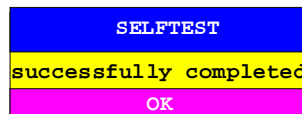

If a failure occurs during the execution of the self test, the self test is immediately aborted and a message indicating the defective module and the defective function is displayed:

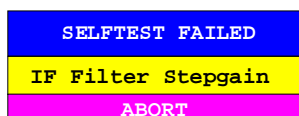

Further testing should be performed by an R&S service department.

IEC/IEEE- bus command : *TST?

System Messages

The *SYSTEM MESSAGES* softkey opens a submenu with a table in which the generated system messages are displayed. The most recent messages are at the top of the list.

The following information is presented:

- NO Device-specific three-digit error code (shown as XXX in the figure)
- MESSAGE Brief description of the reason for the message
- DATE/TIME Date and time of the message

Error messages that have occurred since the *SYSTEM MESSAGES* menu was last called are marked by an asterix "*".

SYSTEM INFO-SYSTEM MESSAGES submenu:

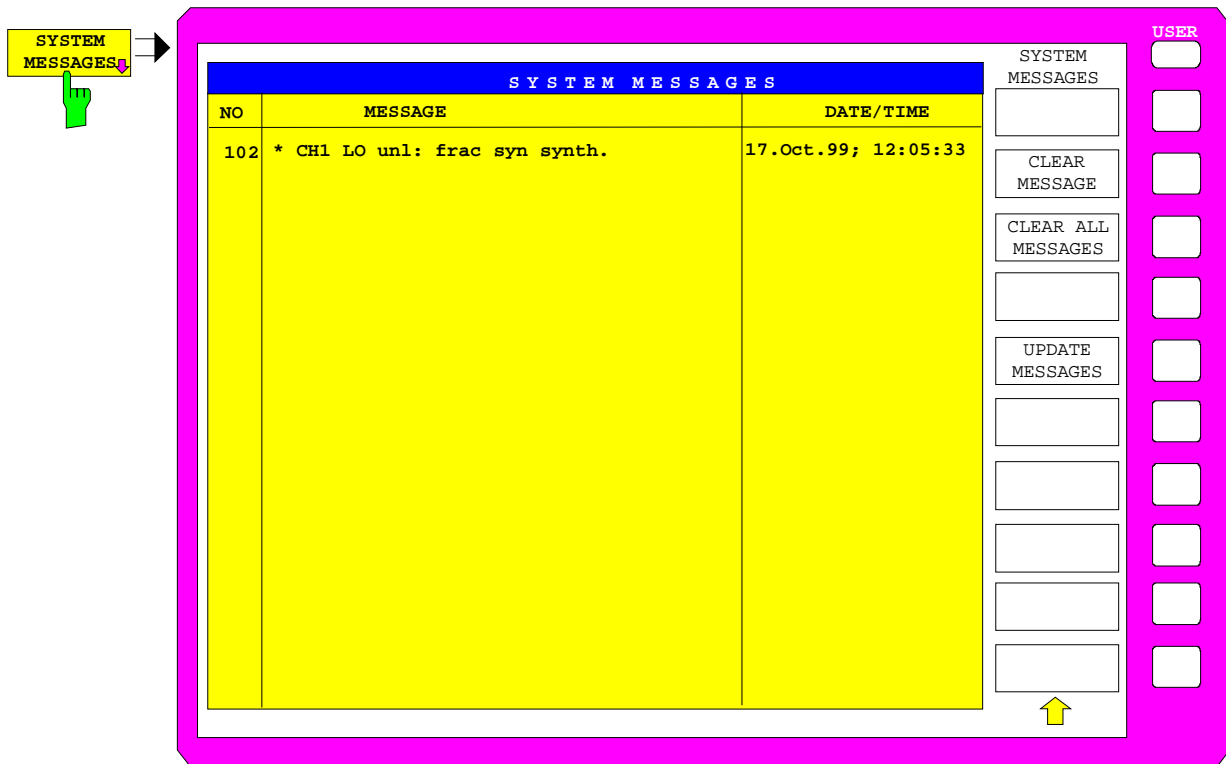

IEC/IEEE- bus command : `SYSTem:ERRor?`

CLEAR MESSAGE



The *CLEAR MESSAGE* softkey deletes the message just selected. All subsequent messages are shifted automatically one line upwards so that no empty lines exist. When the last message has been deleted, the selection bar also disappears.

IEC/IEEE- bus command : `SYSTem:ERRor?`

CLEAR ALL MESSAGES



The *CLEAR ALL MESSAGES* softkey deletes all messages.

IEC/IEEE- bus command --

UPDATE MESSAGES



The *UPDATE MESSAGES* softkey causes all newly arrived messages to be entered at the top of the table. At this time, all messages previously indicated as "new" are displayed as "old" messages

IEC/IEEE- bus command --

Statistics Function for Input Attenuator Switching

SYSTEM INFO menu:

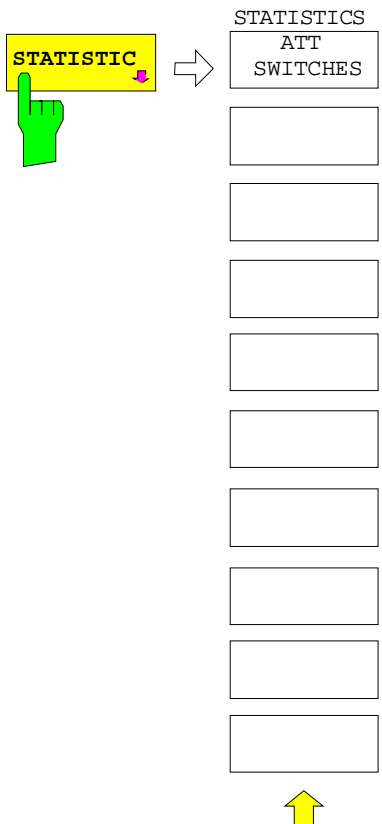

The *STATISTICS* softkey calls a submenu for indication of device statistics.

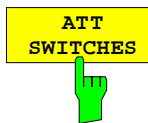

The *ATT SWITCHES* softkey displays various tables listing the mechanical switches and attenuators fitted in the instrument, plus the number of switching operations for the respective switch or attenuator.

| INPUT ATTENUATOR | |
|-------------------|------------|
| Date | 5 Aug 1999 |
| Calibration Input | 6 |
| 10 dB | 121 |
| 20 dB | 217 |
| 30 dB | 137 |

IEC/IEEE- bus command
 :DIAGnostic:INFO:CCOunt:ATTenuation <1|2|3>

Mode Selection – *MODE* Key

The FSE can be operated in one of several modes, each of which is different with respect to functionality and control. The differences in control, however, consist not only in the enabling/disabling of additional softkeys within existing softkey menus, but rather in the fact that existing menus are completely replaced by new menus and menu trees which are tailored to the functional requirements. In the simultaneous application of two measurement diagrams, two modes may also simultaneously enabled. Each mode can be assigned to a measurement window.

CONFIGURATION MODE menu

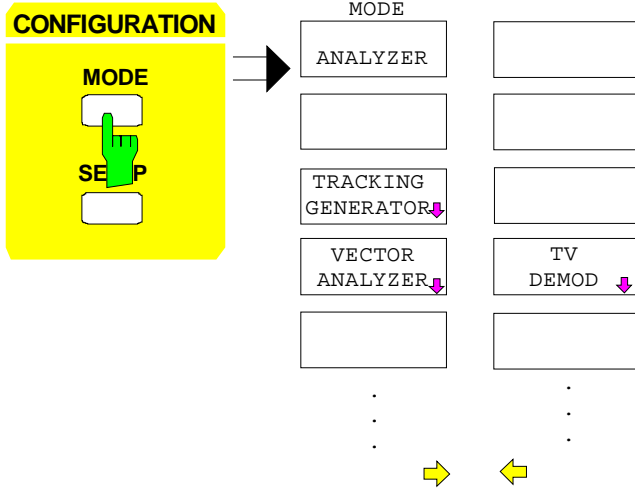

The *MODE* key opens the menu for selection of the mode.

Herein, the modes can be selected according to the available FSE options.

- Analyzer
- Tracking Generator
- Vector Signal Analysis and
- TV Demodulation



The *ANALYZER* softkey selects the *ANALYZER* mode.

This mode is the default setting of the FSE.

The functions provided correspond to those of a conventional spectrum analyzer. The analyzer measures the frequency spectrum of the test signal over the selected frequency range with the selected resolution and sweep time, or, for a fixed frequency, displays the waveform of the video signal.

IEC/IEEE-bus command :INSTRument[:SElect] SANalyzer



The *TRACKING GENERATOR* softkey selects the operating mode Scalar Network Analysis.

The softkey is only available if FSE is equipped with one of the following options: FSE-B8/B9/B10 and B11. For a detailed description of operation see Section 'Option Tracking Generator'.

IEC/IEEE-bus command :OUTPut[:STATe] ON | OFF

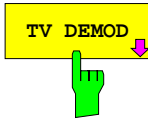

The *TV DEMOD* softkey selects the operating mode TV Demodulation. The softkey is only available if FSE is equipped with Option FSE-B3. For a detailed description of operation see manual of options.

IEC/IEEE-bus command `[:SENSE] :TV:STATE ON | OFF`

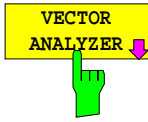

Softkey *VECTOR ANALYZER* selects the vector analysis mode.

The softkey is only available if FSE is equipped with Option FSE-B7.

In the vector analyzer mode the FSE is automatically set to a fixed frequency (center frequency) since vector analysis can only be carried out on one frequency.

The IF signal is digitized by the selected resolution bandwidth after filtering and mixed into the baseband by a digital mixer. Further processing is via digital signal processors which display the time characteristic of the amplitude or phase. As an option, the baseband can also be demodulated and the demodulated signal can be displayed. Principally any type of modulation (digital and analog) can be processed.

The functions of the analyzer mode are supplemented by the vector analysis functions which are described in detail in a separate manual to the option.

IEC/IEEE-bus command `:INSTrument[:SElect] DDEMod`

Preliminary Setup and Interface Configuration – *SETUP* Key

CONFIGURATION SETUP menu:

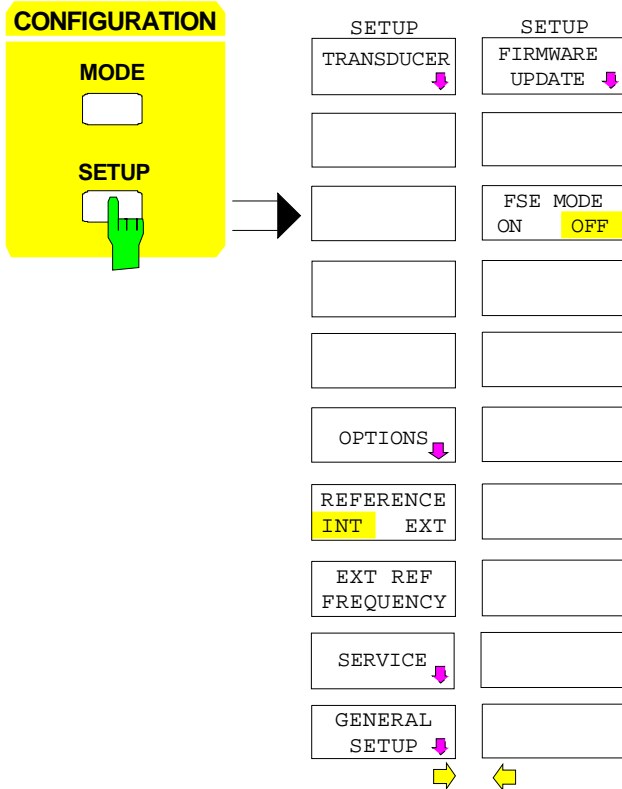

The *SETUP* key opens the menu for configuration of the FSE.

The *TRANSUDUCER* softkey opens a submenu for entering correction characteristics for the measurement transducer.

The *OPTIONS* softkey allows the enabling of firmware options (Application Firmware Modules).

The *REFERENCE INT/EXT* and *EXTERNAL REF FREQUENCY* softkeys determine the reference to be used.

The *SERVICE* softkey provides special setup functions which, although not necessary in normal use, are useful in instrument service.

The *GENERAL SETUP* softkey opens a submenu for all the general settings such as date and time as well as the configuration of the device interfaces.

The *FIRMWARE UPDATE* softkey opens a submenu for the installation of a firmware update.

Using Transducers

A transducer is often connected ahead of FSE both during the measurement of useful signals and EMI and converts the useful or interference variable such as field strength, current or RFI voltage into a voltage across 50 Ohm. Transducers with a frequency-independent transducer factor can be coded in 10-dB steps together with the unit at connector *PROBE CODE*. They are supplied at the same time by this connector. Transducers such as antennas, probes or current probes mostly have a frequency-dependent transducer factor which can be stored in FSE and automatically has the correct unit during level measurement.

If a transducer is switched on it is considered as part of the unit during the measurement, ie the measured values are displayed in the correct unit and magnitude. When working with two measurement windows, the transducer is always assigned to two windows.

FSE distinguishes between **transducer factor** and **transducer set**. A transducer factor takes the frequency response of a single transfer element, eg an antenna into consideration. A transducer set can summarize different transducer factors in several subranges (several transducer factors at the same time), eg an antenna, a cable and a diplexer.

A transducer factor consists of max. 50 reference values defined with frequency, transducer factor and the unit. For the measurement between frequency values linear or logarithmic interpolation of the transducer factor can be chosen.

Several factors can be compiled in a transducer set provided that all factors have the same unit or unit "dB". The frequency range covered by a set can be subdivided into max. 10 subranges (each with up to 4 transducer factors) which follow each other without a gap, ie the stop frequency of a subrange is the start frequency of the next subrange.

The transducer factors used in a subrange have to fully cover the subrange.

The definition of a transducer set is recommended if different transducers are used in the frequency range to be measured or if a cable attenuation or an amplifier has to be taken into consideration.

If a transducer set is defined during a frequency sweep, the latter can be stopped at the interface between two transducer ranges and the user is asked to exchange the transducer.

The following message informs the user that the limit has been reached:

TDS Range # reached, CONTINUE / BREAK

He can continue the sweep by confirming the message (*CONTINUE*) or he can switch off the transducer (*BREAK*).

With the automatic switchover of the transducer used, the frequency sweep is not interrupted.

Note: *Transducers cannot be used in vector analyzer mode.*

Activating Transducer Factors and Transducer Sets

The *TRANSDUCER* softkey opens a submenu in which already defined transducer factors or sets can be activated or deactivated, new transducer factors or sets can be generated or existing transducer factors or sets can be edited. Tables with the defined transducer factors and sets are displayed. The table (factor or set) in which a transducer is active is set.

By switching on the transducers all the level settings and outputs are automatically made in the unit of the transducer. A change of the unit in menu *LEVEL REF* is no longer possible as FSE together with the transducer used is regarded as a measuring instrument. Only if the transducer has the unit dB, can the original unit at FSE be maintained and changed.

Note: *If one of the units $\text{dB}\mu\text{V}$, $\text{dB}\mu\text{V}/\text{m}$, $\text{dB}\mu\text{A}$, or $\text{dB}\mu\text{A}/\text{m}$ is selected, the *LEVEL REF* key (see *UNIT*-submenu) can be used to switch to the corresponding units referred to the bandwidth, i.e. $\text{dB}\mu\text{V}/\text{MHz}$, $\text{dB}\mu\text{V}/\text{mMHz}$, $\text{dB}\mu\text{A}/\text{MHz}$, $\text{dB}\mu\text{A}/\text{mMH}$.*

If a transducer factor is active, TDF is displayed in the column of the enhancement labels and TDS if the transducer set is active.

After switching off all the transducers, FSE continues to use the unit which was selected before a transducer was switched on.

In the analyzer mode, an active transducer for a sweep is uniquely calculated for each point displayed after its setting and added to the result of the level measurement during the sweep. If the sweep range is changed, the correction values are recalculated. If several measured values are combined, only a single value is taken into consideration.

If an active transducer factor/set is not defined over the whole sweep or scan range during the measurement, the missing values are replaced by zero.

CONFIGURATION SETUP Menu

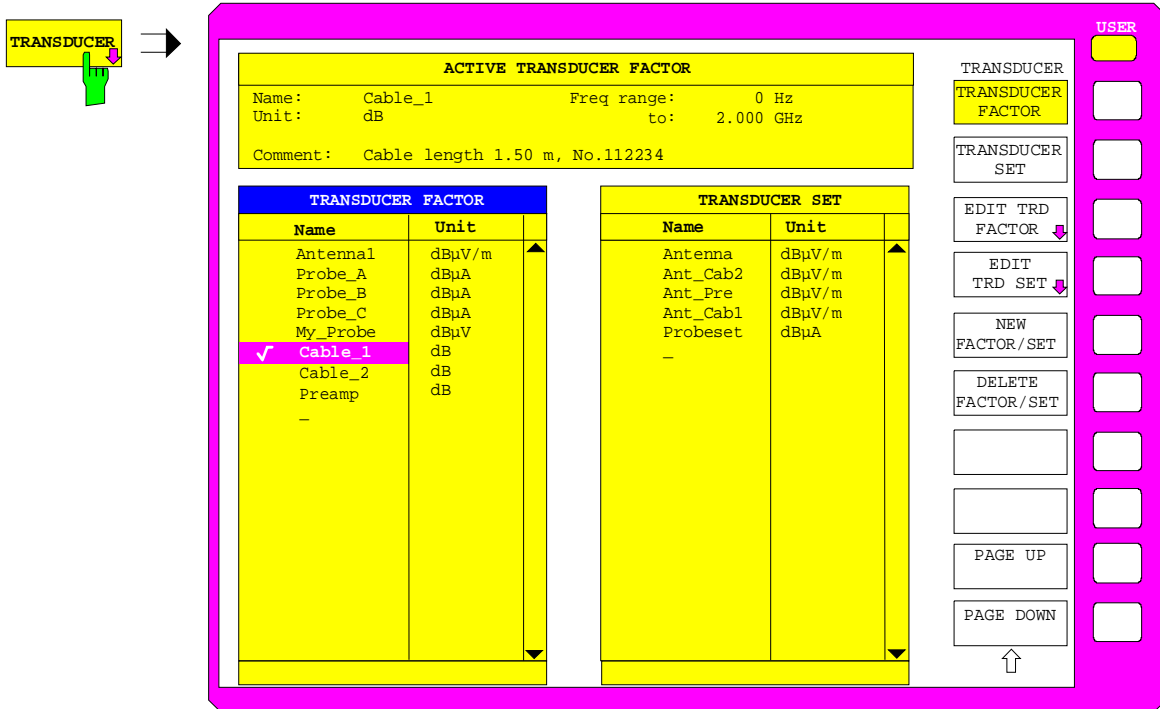

The upper table *ACTIVE TRANSDUCER FACTOR / SET* indicates the active transducer factor or the set with the associated name, frequency range and unit. If no factor or set is active, *none* is displayed in the table. Additional information can be entered in a comment line. If a transducer factor is active, the selected interpolation is displayed in addition, if a set is active, the break setting is displayed.

The left table *TRANSDUCER FACTOR* comprises all the defined factors with name and unit. If the number of defined transducer factors exceeds the number of possible lines in the table, the table will be scrolled.

The right table *TRANSDUCER SET* comprises all the defined transducer sets with the corresponding information.

Only one set or transducer can be activated. An already active transducer factor or set is switched off automatically if another one is switched on. An activated transducer factor or set is marked with a check sign.

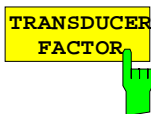

The *TRANSDUCER FACTOR* softkey sets the selection bar to the position of the active transducer factor.

If no transducer factor is switched on, the bar is positioned to the first line of the table.

IEC/IEEE bus commands

```
:[SENSE<1|2>:]CORRection:TRANsducer:SElect <name>
:[SENSE<1|2>:]CORRection:TRANsducer[:STATE] ON | OFF
```

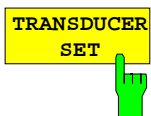

The *TRANSDUCER SET* softkey sets the selection bar to the position of the active transducer set.

If no transducer set is switched on, the bar is set to the first line of the table.

IEC/IEEE bus commands

```
:[SENSE<1|2>:]CORRection:TSET:SElect <name>
:[SENSE<1|2>:]CORRection:TSET[:STATE] ON|OFF
```



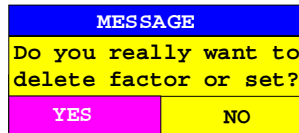

The *DELETE FACTOR/SET* softkey deletes the marked factor or set. To avoid deletion by mistake, deletion has to be confirmed.

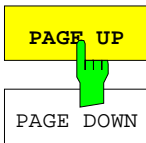

IEC/IEEE-bus command

```
: [SENSe<1 | 2>: ]CORRection:TRANsdruce:r:DELeTe
: [SENSe<1 | 2>: ]CORRection:TSET:DELeTe
```



The *PAGE UP* and *PAGE DOWN* softkeys are used to scroll in large tables which cannot fully be displayed on the screen.

New Entry and Editing of Transducer Factors

A transducer factor is characterized by

- reference values with frequency and transducer factor (*Values*)
- the unit of the transducer factor (*Unit*) and
- the name (*Name*) to distinguish between the different factors.

During the entry, FSE checks the transducer factor according to specific rules that have to be met to ensure trouble-free operation.

- The frequencies for the reference values always have to be entered in ascending order. Otherwise, the entry is not accepted and the following message is displayed:

Frequency Sequence!

- The entered frequencies do not necessarily have to be set at FSE, as only the values for the frequency display range are considered for a set sweep or scan. The minimum frequency for a reference value is 0 Hz, the maximum frequency 200 GHz.
- The minimum or maximum value for a transducer factor is -200 dB or 200 dB. The unit "dB" means that the transducer factor is always logarithmic and has nothing to do with the physical transducer factor, which, for example, establishes the relationship between field strength and voltage into 50 Ohm. If the minimum or maximum value is exceeded, FSE signals:

*Min Level -200 dB or
Max Level 200 dB.*

- Amplifiers have a negative transducer factor, attenuation values have to be entered as a positive transducer factor.

Note: *A unit activated by switching on the transducer has priority over a coded unit of the connected probe.*

With the exception of dB/MHz, the softkeys for the unit in the menu under key LEVEL REF are inoperative with the transducer switched on.*

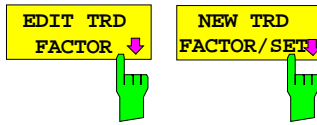

The *EDIT TRD FACTOR* and *NEW FACT/SET* softkeys both open the submenu for editing and entering new transducer factors. A precondition for the *NEW FACTOR/SET* softkey is that the selection bar is located in the table when the table *TRANSDUCER FACTOR* is called up.

| EDIT TRANSDUCER FACTOR | | | |
|---------------------------|----------|-----------|----------|
| Name: Antennal | | | |
| Unit: dBuV/m | | | |
| Interpolation: LIN | | | |
| Comment: Ant1 and cable 1 | | | |
| FREQUENCY | TDF/dB.. | FREQUENCY | TDF/dB.. |
| 20.0000 MHz | 25.5 | | |
| 25.0000 MHz | 23.8 | | |
| 30.0000 MHz | 20.5 | | |
| 40.0000 MHz | 19.8 | | |
| 50.0000 MHz | 20.0 | | |
| 60.0000 MHz | 19.5 | | |
| 70.0000 MHz | 19.1 | | |
| 80.0000 MHz | 18.2 | | |

The table with the data of the marked factor (the *EDIT TRD FACTOR* softkey) or an empty table is displayed in which the following entries are preset (the *NEW FACTOR/SET* softkey):

- Unit: dB
- Interpolation: LIN for linear frequency scaling
LOG for logarithmic frequency scaling

The characteristics of the factor can be entered in the header field of the table, the frequency and the transducer factor in the columns of the table.

- Name* Entry of the name
- Unit* Selection of unit
- Interpolation* Selection of interpolation
- Comment* Entry of a comment
- FREQUENCY* Entry of the frequency of the reference points
- TDF/dB* Entry of the transducer factor.

An overwritten transducer factor remains stored in the background as long as the edited factor is stored with the *SAVE TRD FACTOR* softkey or until the table is closed. A factor overwritten by mistake can be restored by leaving the entry.



The *TRD FACTOR NAME* softkey activates the entry of the transducer factor characteristics in the header field of the table.

Name - Entry of name

A maximum of 8 characters is permissible for the name. The characters have to comply with the convention of DOS file names. The unit automatically stores all transducer factors with the extension .TDS.

If an existing name is changed, the factor stored under the previous name is retained and will not be overwritten automatically with the new name. The previous factor can be deleted at a later time, using *DELETE FACTOR/SET*. Thus, factors can be copied.

IEC/IEEE-bus command : [SENSe<1 | 2>:]CORR:TRAN:SElect <name>

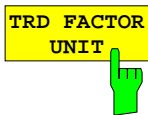

Unit - Selection of unit

The unit of the transducer factor is selected from a selection box activated by the *TRD FACTOR UNIT* softkey.

| FACTOR UNIT |
|-------------|
| dB |
| dBm |
| dBµV |
| dBµV/m |
| dBµA |
| dBµA/m |
| ✓ dBpW |
| dBpT |

The default setting is dB.

IEC/IEEE-bus command : [SENSe<1 | 2>:]CORR:TRAN:UNIT <string>

Interpolation - Selection of interpolation

Linear or logarithmic interpolation can be carried out between the frequency reference points of the table. Selection is via the ENTER key which is toggled between LIN and LOG (toggle function).

The following diagrams indicate the effect of the interpolation on the calculated characteristic:

IEC/IEEE-bus command : [SENSe<1 | 2>:]CORR:TRAN:SCAL LIN|LOG

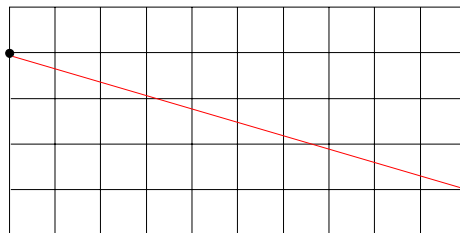

Fig. 4-1 Linear frequency axis and linear interpolation

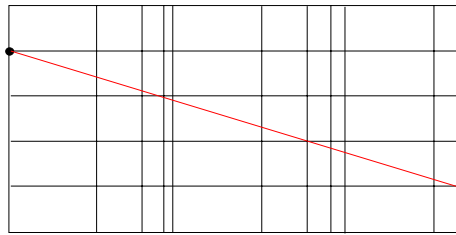

Fig. 4-2 Logarithmic frequency axis and logarithmic interpolation

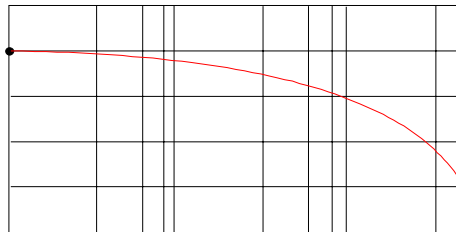

Fig. 4-3 Logarithmic frequency axis and linear interpolation

Comment - Entry of a comment

The comment can be freely selected. It can have a maximum number of 50 characters.

IEC/IEEE-bus command : [SENS<1 | 2>:]CORR:TRAN:COMM <string>

The *TRD FACTOR VALUES* softkey activates the entry for the reference values of the transducer factor.

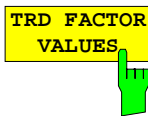

The selection bar marks the first reference value. The desired reference values have to be entered in ascending frequency sequence.

After entering the frequency the selection bar automatically jumps to the corresponding level value. After entering the first reference value the table can be edited. The two *INSERT LINE* and *DELETE LINE* softkeys are displayed. Individual values are changed at a later time by marking the field and by entering the new value.

IEC/IEEE-bus command : [SENS<1 | 2>:]CORR:TRAN:DATA
 <freq>, <level>

The *INSERT LINE* softkey inserts a free line above the marked reference value. When entering a new reference value into this line watch out for the ascending frequency sequence.

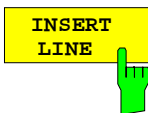

The *DELETE LINE* softkey deletes the marked reference value (the whole line). The following reference values move up.

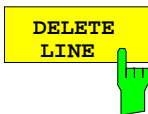

IEC/IEEE-bus command --

The *SAVE TRD FACTOR* softkey saves the changed table in a file on the internal hard disk.



If a transducer factor with the same name already exists, a corresponding query is performed beforehand.

If the factor to be newly saved is currently switched on, the new values will immediately be valid. If a transducer set is switched on comprising the factor, the values will only be used when the set is switched on next time.

IEC/IEEE-bus command - (executed automatically)

New Entry and Editing of Transducer Sets

A transducer set is characterized by:

- maximum 10 ranges (*Ranges*) in which different transducer factors can be active
- the combination of several transducer factors per range (*Factor*)
- a transducer-set name (*Name*)

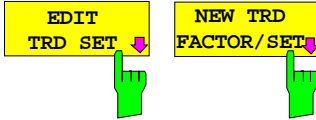

The *EDIT TRD SET* and *NEW FACTOR/SET* softkeys both open the submenu for editing and entering new transducer factors. A precondition for the *NEW FACTOR/SET* softkey is that the selection bar is located in the table *TRANSDUCER SET*.

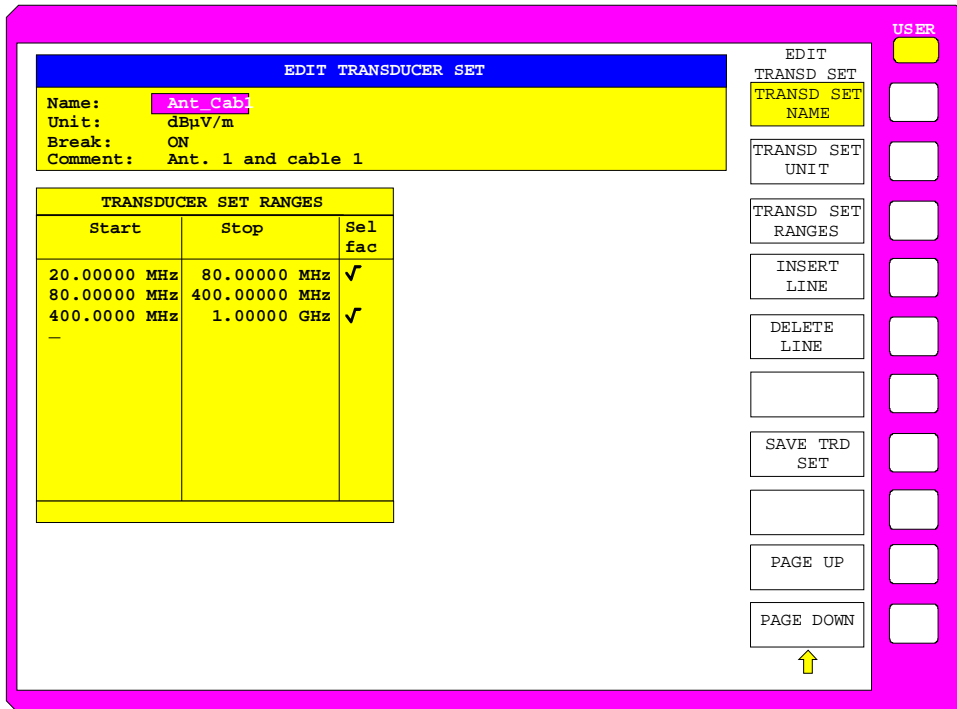

The table with the data of the marked set (the *EDIT TRD SET* softkey) or an empty table in which the following entries are preset (the *NEW FACTOR/SET* softkey) is displayed:

Unit: dB
 Break: NO

The characteristics of the set can be entered in the header field of the table, the subranges in the columns of the set.

- Name* Entry of the name
- Unit* Selection of unit
- Break* Activating the query when changing the subrange
- Comment* Entry of a comment
- Start* Entry of the start frequency of the subrange
- Stop* Entry of the stop frequency of the subrange
- Sel Fac* Selection of the transducer factors for the subrange

An overwritten transducer set remains stored in the background as long as the edited factor is stored with the *SAVE TRD SET* softkey or until the table is closed. A set overwritten by mistake can be restored by leaving the entry.

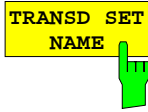

The *TRD SET NAME* softkey activates the entry of the transducer set characteristics in the header field of the table.

Name - Entry of name

A maximum of 8 characters is permissible for the name. The characters have to comply with the convention of DOS file names. The unit automatically stores all transducer sets with the extension .TDS.

If an existing name is changed, the set stored under the previous name is retained and will not be overwritten automatically with the new name. The previous set can be deleted at a later time using *DELETE FACTOR/SET*. Thus, sets can be copied.

IEC/IEEE-bus command : [SENSe<1 | 2>:]CORR:TSET:SELEct <name>

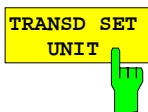

Unit - Selection of unit

The unit of the transducer set is selected from a selection box activated by the *TRANSD SET UNIT* softkey.

The unit should be selected prior to the entry as it determines the settable transducer factors. The preset unit for new sets is "dB". The unit can no longer be changed when editing a set as the set of selected transducer factors will otherwise become inconsistent.

| SET UNIT |
|----------|
| dB |
| dBm |
| dBµV |
| dBµV/m |
| dBµA |
| dBµA/m |
| ✓ dBpW |
| dBpT |

IEC/IEEE-bus command : [SENSe<1 | 2>:]CORR:TSET:UNIT <string>

Break - Activation of query when changing a subrange

The sweep can be stopped if the user changes the subrange and selects a new subrange of the transducer. A message informs the user that the limit has been attained. He can continue the sweep or switch off the transducer.

The interruption is activated by setting Break to ON. Selection is by the ENTER key which toggles between ON and OFF (toggle function).

IEC/IEEE-bus command : [SENSe<1 | 2>:]CORR:TSET:BREAk ON|OFF

Comment - Entry of a comment

The comment can be freely selected. It can have a maximum number of 50 characters.

IEC/IEEE-bus command : [SENSe<1 | 2>:]CORR:TSET:COMMEnt <string>



Softkey *TRANSD SET RANGES* activates the entry of subranges and the associated transducer factors. The selection bar marks the frequency values last active.

Start - Entry of start frequency of subrange
Stop - Entry of stop frequency of subrange

The individual subranges have to be linked without a gap. That is why the start frequency is already defined from the second subrange (= stop frequency of previous range).

After entering the first frequency value the table can be edited. The two *INSERT LINE* and *DELETE LINE* softkeys are displayed. Some values are changed at a later time by marking the field and by entering the new value. It should be noted that both the stop frequency of a particular subrange and the start frequency of the subsequent subrange are changed to the same extent.

IEC/IEEE-bus command
`: [SENSE<1|2>:]CORRection:TSET:RANGe<1..10>
 <freq>, <freq>, <name>..`

Sel fac- Selection of factors for the subrange

A check sign in column *Sel Fac* (select factor) indicates whether one or several transducer factors were selected for the subrange.

The permissible transducer factors for the marked subrange can be selected in a selection box. Only factors matching with the unit of the set and fully covering the selected subrange are permissible.

After each change of range limits, FSE thus checks the factor list and, if required, rebuilds it.

After reducing the start frequency or increasing the stop frequency of a range it may happen that the factors defined for this range no longer fully cover the range. These factors are deleted for this range when the transducer factor table is opened next time.

A maximum of 4 transducer factors can be switched on at the same time in each subrange. If none of them is switched on, 0 dB is assumed as a factor for the whole subrange.

| SELECT TRANSDUCER FACTOR | | |
|--|--------|---|
| Name | Unit | |
| <input checked="" type="checkbox"/> Antenna1 | dBµV/m | ▲ |
| Probe_A | dBµV/m | |
| Probe_B | dBµV/m | |
| Probe_C | dBµV/m | |
| My_Probe | dB | |
| <input checked="" type="checkbox"/> Cable_1 | dB | |
| Cable_2 | dB | |
| <input checked="" type="checkbox"/> Preamp | dB | |

IEC/IEEE-bus command --

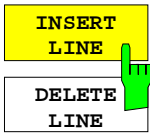

The *INSERT LINE* softkey inserts a free line above the marked subrange.
 The *DELETE LINE* softkey deletes the marked subrange (whole line). The following subranges move up.
 In both cases FSE checks that the ranges follow each other without a gap.
 IEC/IEEE-bus command --



The *SAVE TRD SET* softkey saves the changed table in a file on the internal hard disk. If a transducer name with the same name already exists, a corresponding query is performed beforehand:

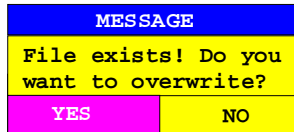

After pressing ENTER, the data set is overwritten on the hard disk. If the saved set is switched on, the new values will be used immediately.
 IEC/IEEE-bus command -- (executed automatically)

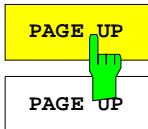

The *PAGE UP* and *PAGE DOWN* softkeys set the table to the next or previous page.
 The softkeys are locked during selection of factors in the right table.

Enabling Firmware Options

CONFIGURATION SETUP menu:

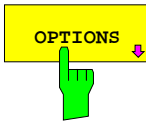

The *OPTIONS* softkey opens a submenu for entering keywords for new firmware options (Application Firmware Modules). Options which are already available are indicated in a table that is opened when the menu is called.

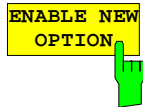

The *ENABLE OPTION* softkey activates the entry of a keyword for a firmware option.

One or several keywords may be specified in the entry field. When a valid keyword is entered, the message *OPTION KEY OK* appears in the info line and the option is written into the *FIRMWARE OPTIONS* table.

The *FIRMWARE OPTIONS* table can also be displayed using the *FIRMWARE OPTIONS* softkey in the *INFO* menu.

If a keyword is invalid the message *OPTION KEY INVALID* is displayed in the info line.

IEC/IEEE-bus command --

External Reference Oscillator

In general, the FSE can generate all internal oscillators from either the internal or an external reference oscillator. A 10 MHz crystal oscillator is used as the internal reference source. A reference oscillator output is also available at the rear panel via the EXT REF IN/OUT connector.

This output can be used, e.g., to synchronize other instruments to the FSE. This connector can also be used as an input connector for application of an external frequency standard. The FSE requires that the frequency of the external standard be entered so that the internal oscillators can be synchronized to it.

CONFIGURATION SETUP Menu:

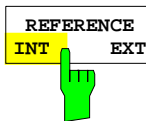

The *REFERENCE INT EXT* softkey toggles between the internal and external references.

IEC/IEEE-bus command : [SENSe<1|2>:]ROSC:SOURce INT | EXT



The *EXT REF FREQUENCY* softkey activates the entry of the frequency of the external source.

Range of input values is 1 MHz to 16 MHz in 1 MHz steps.

IEC/IEEE-bus command : [SENSe<1|2>:]ROSC:EXT:FREQ 13 MHz

Service Functions

The service menu offers a variety of additional functions which are used for maintenance and/or trouble shooting. The service functions are not necessary for normal measurements, however, incorrect use can impair the functionality and/or data integrity of the FSE. Therefore, many of the functions can only be used after entering a password.

CONFIGURATION SETUP menu:

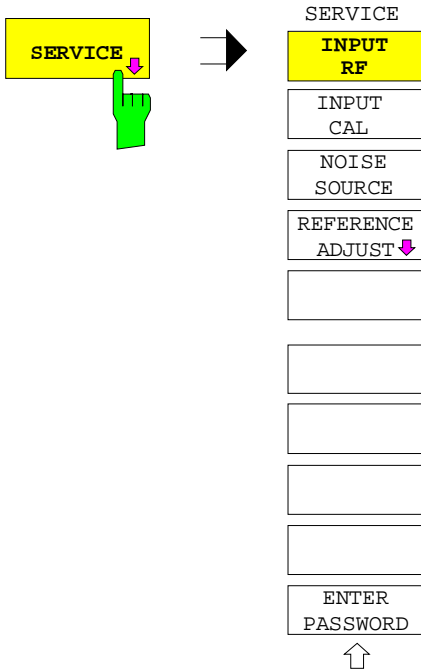

The *SERVICE* softkey calls the service submenu.

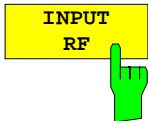

The *INPUT RF* and *INPUT CAL* softkeys are mutually exclusive selection switches. Only one switch can be activated at any one time. They switch the input to the FSE between the *INPUT RF* connector (default) and the internal calibration source (120 MHz, -40 dBm).

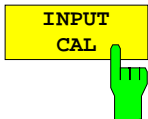

After *PRESET*, *RECALL* or FSE power on, the *INPUT RF* is always selected.

IEC/IEEE-bus command

```
:DIAGnostic:SERvice:INPut[:SElect] RF | CAL
```

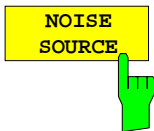

The *NOISE SOURCE* softkey switches the supply voltage for an external noise source on or off. The source is connected to the *NOISE SOURCE* connector on the instrument's rear panel.

The dc voltages on the connector are described in Chapter 8.

```
IEC/IEEE-bus command :DIAGnostic:SERvice:NSource ON | OFF
```

CONFIGURATION SETUP SERVICE menu:

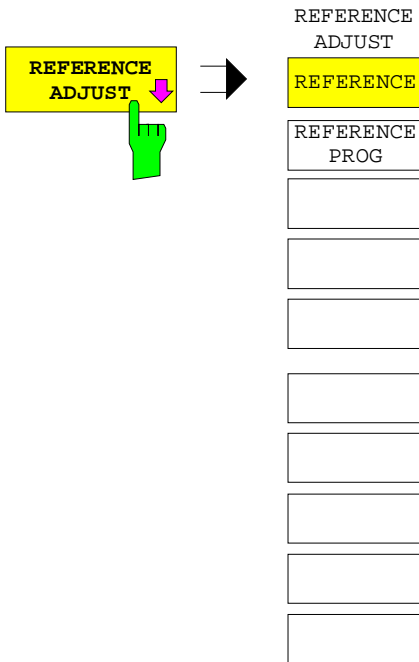

The *REFERENCE ADJUST* softkey opens a submenu used to adjust the frequency precision of the reference oscillator. The value should be modified only after the frequency precision was checked and found to be erroneous (setting range 0 to 4095).

For more information about how to perform the adjustment of the frequency precision refer to service manual instrument (delivered with the FSE).

The modified reference value is preserved when the menu is closed.

The current adjustment value can be permanently stored in an EEPROM in the instrument.

Caution: *As the specifications of the whole instrument depend directly on the setting of the reference oscillator (frequency precision), storing incorrect adjustment values should be avoided.*

Note: *If no adjustment value has been stored (REFERENCE PROG softkey) before the analyzer is switched off and on again, the factory-set value of the reference frequency or the value that has been programmed last will be used.*

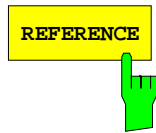

The *REFERENCE* softkey adjusts the frequency precision of the reference oscillator.

IEC/IEEE-bus command
`: [SENSe<1 | 2>:]ROSC: [INT:]TUNe <num_value>`

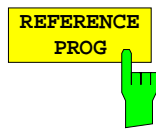

The *REFERENCE PROG* softkey stores the current adjustment value in an EEPROM in the instrument.

IEC/IEEE-bus command
`: [SENSe<1 | 2>:]ROSC: [INT:]TUNe: SAVE`



The *ENTER PASSWORD* softkey allows the entry of a password.

The FSE has a variety of service functions which, if incorrectly used, can impair the functionality of the instrument. These functions can only be accessed with a password (*ENTER PASSWORD*).

IEC/IEEE-bus command `:SYSTem:PASSword[:CENable] <string>`

Setting the Interface Configuration and Time - with Windows NT Controller

The *GENERAL SETUP* softkey opens a submenu in which the general instrument setup can be entered. The current settings are displayed as tables on the screen where they may be edited.

CONFIGURATION SETUP menu:

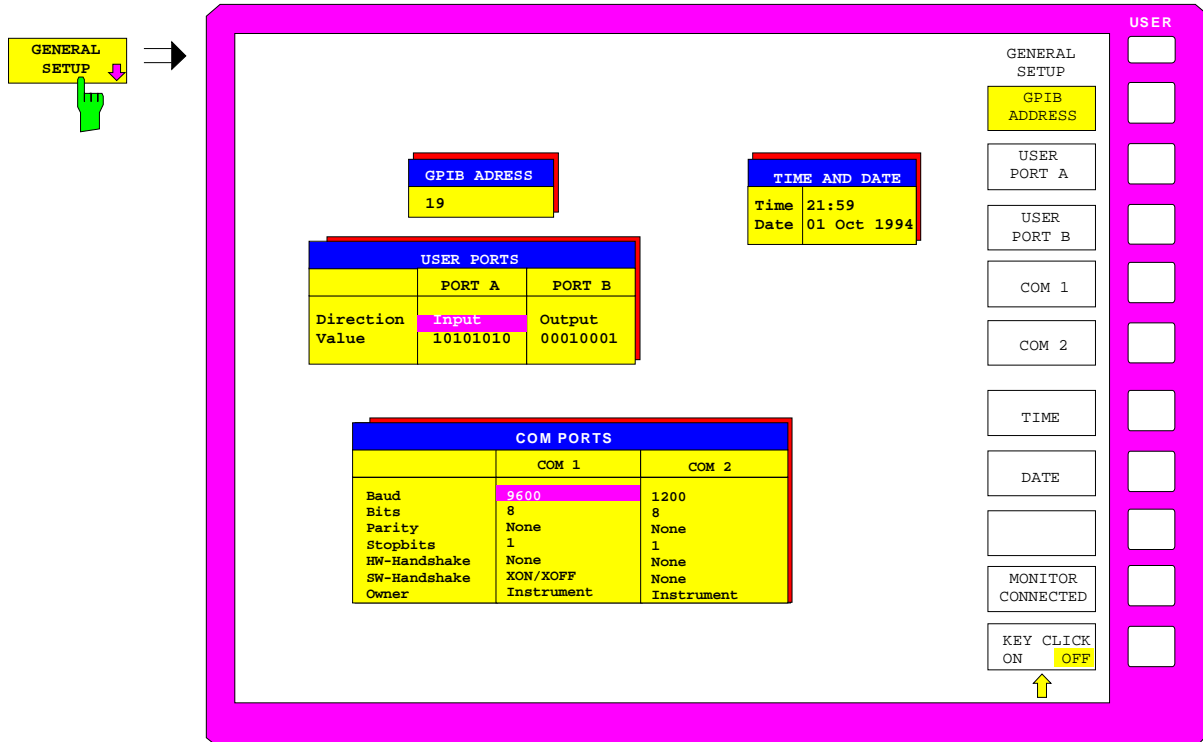

IEC/IEEE-Bus Address Selection - with Windows NT Controller

CONFIGURATION SETUP-GENERAL SETUP submenu:



The *GPIB ADDRESS* softkey activates the entry of the IEC/IEEE-bus address.

The range is 0 to 31. The default setting is 20.

IEC/IEEE-bus command
`:SYSTem:COMMunicate:GPIB[:SELF]:ADDRess 20`

User Port Configuration - with Windows NT Controller

The instrument provides two parallel interfaces, each of which is 8 bits wide. Over these ports, arbitrary bit patterns can be output or input. The interfaces are designated *USER PORT A* and *USER PORT B*.

CONFIGURATION SETUP-GENERAL SETUP submenu:

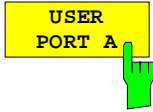

The *USER PORT A* and *USER PORT B* softkeys activate the columns PORT A and PORT B, respectively, in the USERPORTS table for entry of the parameters for both of the parallel interfaces in the instrument. Because the two interfaces are configured in the same manner, how to configure an interface is described in the following using *USER PORT A*.

The following parameters need to be configured in the table:

Direction Direction of data transmission
Value Indication/entry of current value

| USERPORTS | | |
|-----------|----------|--------|
| | PORT A | PORT B |
| Direction | INPUT | OUTPUT |
| Value | 10101010 | |

Direction – Direction of data transmission

The *DIRECTION* parameter determines in which direction the interface transmits data.

INPUT read operation
OUTPUT write operation



IEC/IEEE-bus command : INPut<1|2>:UPORt<1|2>:STATe ON|OFF
 :OUTPut<1|2>:UPORt<1|2>:STATe ON|OFF

Value – Indication/Entry of current value

The *VALUE* parameter shows the current value of the data at the port for data input as well as for data output. The displayed data is in binary format with the least significant bit (LSB) on the right.

If the port is configured as an *OUTPUT* then, the displayed value can be edited. Data entry must also be in binary format (i.e., only the digits 0 and 1 are accepted).

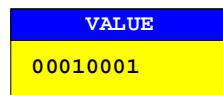

IEC/IEEE-bus command : INPut<1|2>:UPORt<1|2>[:VALue]?
 :OUTPut<1|2>:UPORt<1|2>[:VALue] <Binary>

Serial Interface Configuration - with Windows NT Controller

CONFIGURATION SETUP-GENERAL SETUP submenu:

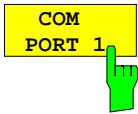

The *COM PORT 1* and *COM PORT 2* softkeys activate the columns COM1 and COM2, respectively, for entry of the serial interface parameters. Since the two interfaces are configured in the same manner, how to configure an interface is described in the following using *COM PORT 1*.

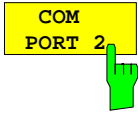

The following parameters must be in the table:

| | |
|---------------------|--|
| <i>Baud rate</i> | data transmission rate |
| <i>Bits</i> | number of data bits |
| <i>Parity</i> | bit parity check |
| <i>Stop bits</i> | number of stop bits |
| <i>HW-Handshake</i> | hardware handshake protocol |
| <i>SW-Handshake</i> | software handshake protocol |
| <i>Owner</i> | assignment of the serial port to the FSE or computer |

| COM PORTS | | |
|--------------|------------|------------|
| | COM 1 | COM 2 |
| Baud | 9600 | 1200 |
| Bits | 8 | 8 |
| Parity | None | None |
| Stopbits | 1 | 1 |
| HW-Handshake | None | None |
| SW-Handshake | XON/XOFF | None |
| Owner | Instrument | Instrument |

Note: A serial interface (COM1 or COM2) cannot be used for another purpose if a mouse is connected to it.

Baud – Data transmission rate

Allowed are the indicated values between 110 and 19200 baud. The default setting is 9600 baud.

| BAUD RATE |
|-----------|
| 19200 |
| ✓ 9600 |
| 4800 |
| 1200 |
| 600 |
| 300 |
| 110 |

IEC/IEEE-bus command

```
:SYSTem:COMMunicate:SERial<1|2>[:RECEive]:BAUD 9600
```

Bits – Number of data bits per word

For the text transmission without special characters, 7 bits are adequate. For binary data as well as text with special characters, 8 bits must be selected (default setting).

| BITS |
|------|
| ✓ 7 |
| 8 |

IEC/IEEE-bus command

```
:SYSTem:COMMunicate:SERial<1|2>[:RECEive]:BITS 7 | 8
```

Parity – Bit parity check*NONE* no parity check (default setting)*EVEN* even parity check*ODD* odd parity check

| PARITY | |
|--------|------|
| | NONE |
| ✓ | EVEN |
| | ODD |

IEC/IEEE-bus command

```
:SYSTem:COMM:SERial<1|2>[:RECeive]:PARity[:TYPE]
                                     EVEN| ODD| NONE
```

Stop bits – Number of stop bits

Available are 1 and 2. The default setting is 1 stop bit.

| STOPBITS | |
|----------|---|
| ✓ | 1 |
| | 2 |

IEC/IEEE-bus command

```
:SYSTem:COMMunicate:SERial<1|2>[:RECeive]:SBITs 1|2
```

HW-Handshake – Hardware handshake protocol

The integrity of data transmission can be improved through the use of a hardware handshake protocol which prevents uncontrolled transmission of data and the resulting possible loss of data bytes. With the hardware handshaking procedure, additional interface lines are used to transmit acknowledge signals with which the data transmission can be controlled and, if necessary, stopped until the receiver is ready to receive data again.

A prerequisite for handshaking is, however, that the interface lines (DTR and RTS) are provided between the sender and receiver. For a simple, 3-wire connection, this is not the case and a hardware handshake cannot be realized.

Default setting is *NONE*.

| HW-HANDSHAKE | |
|--------------|---------|
| | None |
| ✓ | DTR/RTS |

IEC/IEEE-bus command

```
:SYSTem:COMM:SERial<1|2>:CONTrol:DTR IBFull|OFF
:SYSTem:COMM:SERial<1|2>:CONTrol:RTS IBFull|OFF
```

SW-Handshake – Software handshake protocol

Besides the hardware handshake procedure using interface lines, it is also possible to achieve the same effect by using a software handshake protocol. In this case, control bytes are transmitted in addition to the normal data bytes. These control bytes can be used, as necessary, to stop data transmission until the receiver is ready to receive data again.

In contrast to hardware handshaking, software handshaking can be realized even for a simple, 3-wire connection.

Software handshaking, however, does have one limitation. Software handshaking cannot be used for the transmission of binary data since, the control characters XON and XOFF require bit combinations that are also used for binary data transmission.

Default setting is *NONE*.

| | |
|--------------|----------|
| SW-HANDSHAKE | |
| | None |
| ✓ | XON/XOFF |

IEC/IEEE-bus command

```
:SYSTem:COMM:SERial<1|2>[:RECEive]:PACE XON|NONE
```

Owner – Assignment of the interface

The serial interface can be assigned either to the instrument or the computer (operating system, OS).

- INSTRUMENT Assignment to the instrument means that outputs to the port by the OS are not possible as any output would be lost.
- OS Assignment to the operating system means that the instrument cannot use the port, i.e. it is not possible to remote control the instrument via this port.

| | |
|-------|------------|
| OWNER | |
| | INSTRUMENT |
| ✓ | OS |

IEC/IEEE-bus command --

Setting the Date and Time - with Windows NT Controller

CONFIGURATION SETUP-GENERAL SETUP submenu:

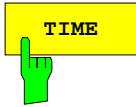

The *TIME* softkey activates the entry of time for the internal real time clock. In the corresponding dialog box, the time is partitioned into two input fields so that hours and minutes can be entered independently.

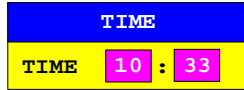

IEC/IEEE-bus command :SYSTem:TIME 0...23, 0...59, 0...59

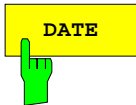

The *DATE* softkey activates the entry of the date of the internal real-time clock. In the corresponding dialog box, the date is partitioned into 3 input fields so that day, month and year can be input separately.

For the selection of the month, pressing a units key opens a list of abbreviations for the months.

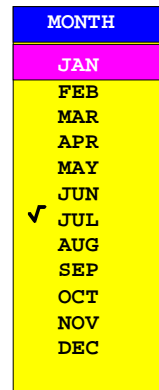
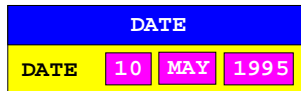

IEC/IEEE-bus command :SYSTem:DATE <num> , <num> , <num>

Connecting the External Monitor - with Windows NT Controller

Submenu CONFIGURATION SETUP-GENERAL SETUP:

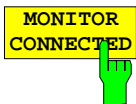

The *MONITOR CONNECTED* softkey informs the unit that an external monitor is available at PC MONITOR connector. The external monitor displays the Windows NT mask.

IEC/IEEE-bus command --

Switching the Beeper ON/OFF - with Windows NT Controller

CONFIGURATION SETUP-GENERAL SETUP submenu:

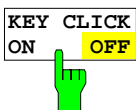

The *KEY CLICK ON/OFF* softkey switches the beeper on or off. The beeper acknowledges each key stroke with a beep.

IEC/IEEE-bus command --

Setting the Interface Configuration and Time - without Controller Option or with MS DOS Controller

The *GENERAL SETUP* soft key branches to a sub-menu in which the basic setup of general instrument parameters may be performed. In addition to the configuration of the digital interfaces (*IECBUS*, *COM*, *LPT* and *MOUSE*), the date and time, the selection of keyboard language as well as the configuration of the *USER PORTS* may be entered.

The current settings are displayed in tabular form on the display screen where they may then be edited.

Note: *Interface LPT cannot be configured. If the option FSE-B15, DOS controller function, is installed, LPT1 can be used for printing in both the measurement instrument mode and the computer mode. However, it can only be used for one mode at a time.*

CONFIGURATION SETUP menu:

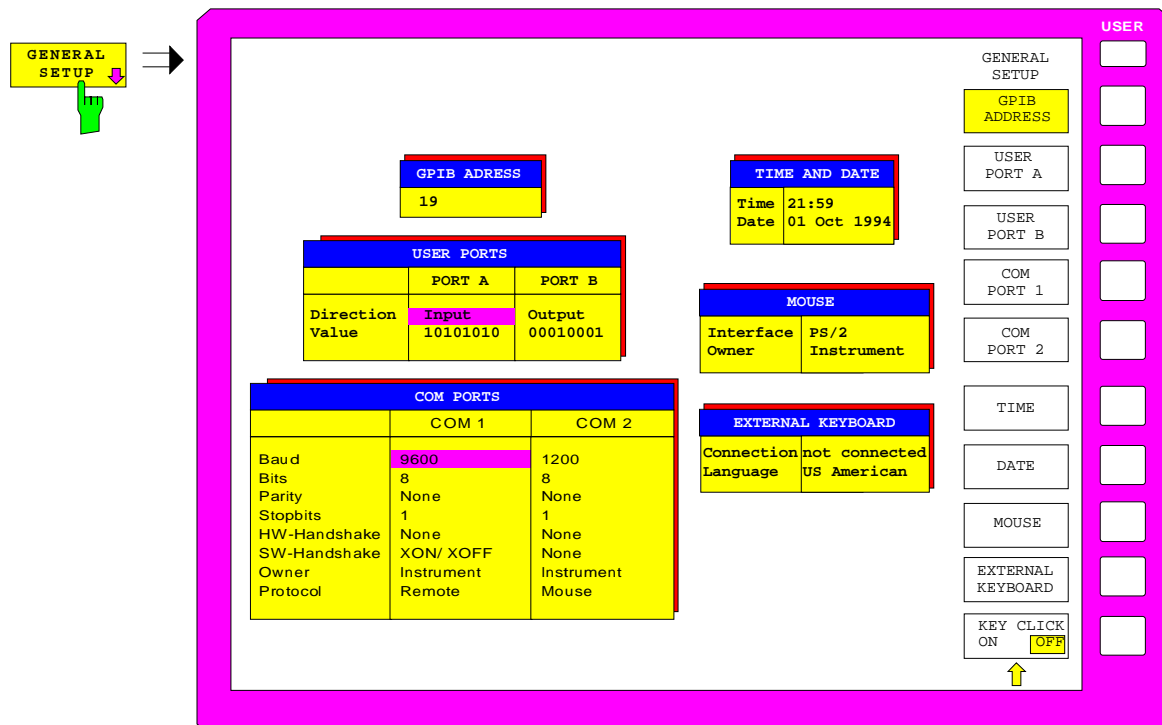

IEC Bus Address Selection

CONFIGURATION SETUP-GENERAL SETUP submenu:



The *GPIB ADDRESS* soft key activates the entry of the IEC Bus address. Permitted addresses are 0 through 30. The default setting is address 20.

Switching the Beeper ON/OFF

CONFIGURATION SETUP-GENERAL SETUP submenu:

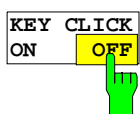

The *KEY CLICK ON/OFF* soft key switches the beeper on or off. The beeper acknowledges each key stroke with a beep.

User Port Configuration - without Controller Option or with MS DOS Controller

The instrument provides two parallel interfaces, each of which is 8 bits wide. Over these ports, arbitrary bit patterns can be output or input. The interfaces are designated *USER PORT A* and *USER PORT B*.

CONFIGURATION SETUP-GENERAL SETUP submenu:

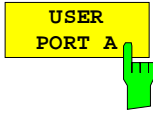

The *USER PORT A* and *USER PORT B* soft keys activate the columns PORT A and PORT B, respectively, in the USERPORTS table for entry of the parameters for both of the parallel interfaces in the instrument. Because the two interfaces are configured in the same manner, how to configure an interface is described in the following using *USER PORT A*.

The following parameters need to be configured in the table:

Direction Direction of data transmission
Value Indication/entry of current value

| USERPORTS | | |
|-----------|----------|--------|
| | PORT A | PORT B |
| Direction | INPUT | OUTPUT |
| Value | 10101010 | |

Direction – Direction of data transmission

The *DIRECTION* parameter determines in which direction the interface transmits data.

INPUT read operation
OUTPUT write operation

| DIRECTION |
|-----------|
| ✓ INPUT |
| OUTPUT |

Value – Indication/Entry of current value

The *VALUE* parameter shows the current value of the data at the port for data input as well as for data output. The displayed data is in binary format with the least significant bit (LSB) on the right.

If the port is configured as an *OUTPUT* then, the displayed value can be edited. Data entry must also be in binary format (i.e., only the digits 0 and 1 are accepted).

| VALUE |
|----------|
| 00010001 |

Serial Interface Configuration - without Controller Option or with MS DOS Controller

CONFIGURATION SETUP-GENERAL SETUP submenu:

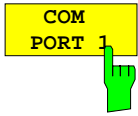

The *COM PORT 1* and *COM PORT 2* soft keys activate the columns COM1 and COM2, respectively, for entry of the serial interface parameters. Since the two interfaces are configured in the same manner, how to configure an interface is described in the following using *COM PORT 1*.

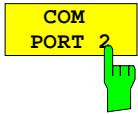

The following parameters need to be configured in the table:

| | |
|---------------------|--|
| <i>Baud rate</i> | data transmission rate |
| <i>Bits</i> | number of data bits |
| <i>Parity</i> | bit parity check |
| <i>Stop bits</i> | number of stop bits |
| <i>HW-Handshake</i> | hardware handshake protocol |
| <i>SW-Handshake</i> | software handshake protocol |
| <i>Owner</i> | assignment to the measuring instrument or computer |
| <i>Protocol</i> | transmission protocol |

| COM PORTS | | |
|--------------|------------|------------|
| | COM 1 | COM 2 |
| Baud | 9600 | 1200 |
| Bits | 8 | 8 |
| Parity | None | None |
| Stopbits | 1 | 1 |
| HW-Handshake | None | None |
| SW-Handshake | XON/XOFF | None |
| Owner | Instrument | Instrument |
| Protocol | Remote | Remote |

Note: A serial interface (COM1 or COM2) cannot be used for another purpose if a mouse is connected to it.

Baud – Data transmission rate

Allowed are the indicated values between 110 and 19200 baud. The default setting is 9600 baud.

| BAUD RATE |
|-----------|
| 19200 |
| ✓ 9600 |
| 4800 |
| 1200 |
| 600 |
| 300 |
| 150 |
| 110 |

Bits – Number of data bits per word

For the transmission of text without German umlauts (Ä, ä, Ü, ü, Ö, ö) and special characters, 7 bits are adequate. For binary data as well as text with special characters or umlauts, 8 bits must be selected (default setting).

| BITS |
|------|
| ✓ 7 |
| 8 |

Parity – Bit parity check

NONE no parity check (default setting)

EVEN even parity check

ODD odd parity check

| |
|--------|
| PARITY |
| NONE |
| ✓ EVEN |
| ODD |

Stop bits – Number of stop bits

Available are 1 and 2. The default setting is 1 stop bit.

| |
|----------|
| STOPBITS |
| ✓ 1 |
| 2 |

HW-Handshake – Hardware handshake protocol

The integrity of data transmission can be improved through the use of a hardware handshake protocol which effectively prevents uncontrolled transmission of data and the resulting possible loss of data bytes. In the hardware handshaking procedure, additional interface lines are used to transmit acknowledge signals with which the data transmission can be controlled and, if necessary, stopped until the receiver is ready to receive data again.

A prerequisite for handshaking is, however, that the interface lines (DTR and RTS) are provided between sender and receiver. For a simple, 3-wire connection, this is not the case and hardware handshake cannot be realized here.

Default setting is *NONE*.

| |
|--------------|
| HW-HANDSHAKE |
| None |
| ✓ DTR/RTS |

SW-Handshake – Software handshake protocol

Besides the hardware handshake procedure using interface lines, it is also possible to achieve the same effect by using a software handshake protocol. Here, control bytes are transmitted in addition to the normal data bytes. These control bytes can be used, as necessary, to stop data transmission until the receiver is ready to receive data again.

In contrast to hardware handshaking, software handshaking can be realized even for a simple, 3-wire connection.

One limitation is, however, present in software handshaking. Software handshaking cannot be used for the transmission of binary data since, the control characters XON and XOFF require bit combinations that are also used for binary data transmission.

Default setting is *NONE*.

| |
|--------------|
| SW-HANDSHAKE |
| None |
| ✓ XON/XOFF |

Owner – Assignment of the interface

When the option FSE-B15, DOS controller, is installed, the serial interface can be assigned alternatively to the instrument measurement section, the DOS section or to both sections of the FSE .

If the interface is assigned to only one section of the instrument, it is not available to the other section.

| | |
|--------------|---|
| INSTRUMENT | The interface is assigned to the instrument measurement section. Outputs to the interface from the computer are not possible and, so to say, land nowhere. |
| DOS | The interface is assigned to the computer section. It cannot be used by the instrument measurement section. This means that hardcopy or remote control of the instrument via the interface is not possible. An attempt to start a print job via the interface results in an error message. The <i>PROTOCOL</i> parameter has no meaning in this mode. |
| INTR AND DOS | The interface is allocated to both instrument sections. It may be used alternately by each section. This means that a hardcopy job from the measurement section and a data transfer from the computer are not possible at the same time. This would lead to a mixing of the data streams. The set interface parameters, with the exception of <i>PROTOCOL</i> , are valid for both instrument sections. The <i>PROTOCOL</i> parameter is only of interest for the measurement section. |

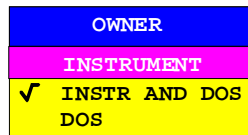

Note: *DOS programs cannot independently recognize changed interface parameter settings.*

Protocol – Transmission protocol

The parameter allows the selection of special transmission protocols for measurement functions. The interface can be configured for:

- remote control as single instrument
- printer output (hardcopy)

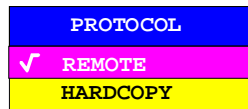

Setting Date and Time - without Controller Option or with MS DOS Controller

CONFIGURATION SETUP-GENERAL SETUP submenu:

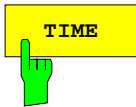

The *TIME* soft key activates the entry of time for the internal real time clock . In the corresponding dialog box, the time is partitioned into two input fields so that hours and minutes can be entered independently.

| TIME | | |
|------|----|------|
| TIME | 10 | : 33 |

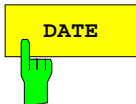

The *DATE* soft key activates the entry of the date of the internal real-time clock. In the corresponding dialog box, the date is partitioned into 3 input fields so that day, month and year can be input separately.

| DATE | | | |
|------|----|-----|------|
| DATE | 10 | MAY | 1995 |

For the selection of the month, pressing a units key opens a list of abbreviations wherein the desired month can be selected.

| MONTH | |
|-------|-----|
| | JAN |
| | FEB |
| | MAR |
| | APR |
| | MAY |
| | JUN |
| ✓ | JUL |
| | AUG |
| | SEP |
| | OCT |
| | NOV |
| | DEC |

Mouse Configuration - without Controller Option or with MS DOS Controller

How to connect a mouse is described in chapter 1, section "Connecting a Mouse", the operation of the instrument with a mouse is described in chapter 2, section "Mouse and External Keyboard Control".



Caution:

The keyboard may only be connected when the instrument is switched off (STANDBY). Otherwise, correct operation of the keyboard cannot be guaranteed.

CONFIGURATION SETUP-GENERAL SETUP submenu:

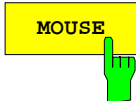

The *MOUSE* soft key activates the *MOUSE* table for configuration of the mouse.

The following parameters need to be configured in the table:

- Interface* Selection of interface
- Owner* Assignment of mouse

| MOUSE | |
|-----------|---------------|
| Interface | NOT CONNECTED |
| Owner | INSTRUMENT |

Interface – Selection of the interface

If one of the serial interfaces is selected (*COM PORT 1* or *COM PORT 2*), its interface parameters are automatically reconfigured so that mouse operation is possible.

- NOT CONNECTED No connection
- PS/2 MOUSE connector on the rear panel
- COM PORT 1 COM1 connector on the rear panel
- COM PORT 2 COM2 connector on the rear panel

| INTERFACE |
|-----------------|
| ✓ NOT CONNECTED |
| PS/2 |
| COM PORT 1 |
| COM PORT 2 |

Owner – Assignment of the mouse

If the processor option FSE-B15 is installed, the mouse can alternately be assigned to the instrument measurement section, the computer section or to both sections simultaneously.

If the mouse is assigned to one section it is not available to the other section.

- INSTRUMENT The mouse is assigned to the instrument measurement section.
- DOS The mouse is assigned to the computer section.
- INTR AND DOS The mouse is assigned to both sections.

| OWNER |
|-----------------|
| INSTRUMENT |
| ✓ INSTR AND DOS |
| DOS |

External Keyboard Configuration - without Controller Option or with MS DOS Controller

How to connect a keyboard is described in chapter 1, section "Connecting an External Keyboard", the operation of the instrument with an external keyboard is described in chapter 2, section "Mouse and External Keyboard Control".



Caution:

The keyboard may only be connected when the instrument is switched off (STANDBY). Otherwise, correct operation of the keyboard cannot be guaranteed.

CONFIGURATION SETUP-GENERAL SETUP submenu:

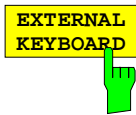

The *EXTERNAL KEYBOARD* soft key activates the *EXTERNAL KEYBOARD* table for configuration of the external keyboard.

Connection Activation of the keyboard connection

Language Language definition for measurement instrument operation

| EXTERNAL KEYBOARD | |
|-------------------|---------------|
| Connection | NOT CONNECTED |
| Language | US-AMERICAN |

Connection – Activating the connection

Activating the connection mainly determines whether or not the help line editor is available.

CONNECTED A keyboard is connected. When an alphanumeric entry window is opened, the help line editor is no longer displayed automatically because it is no longer needed for editing.

NOT CONNECTED The help line editor is opened automatically when alphanumeric parameters are edited.

| CONNECTION |
|-----------------|
| ✓ NOT CONNECTED |
| CONNECTED |

Language – Language definition for measurement instrument operation

Available are US-American, German and French.

| LANGUAGE |
|---------------|
| ✓ US-AMERICAN |
| GERMAN |
| FRENCH |

Note: The language definition of the keyboard in DOS mode is independent of this setting and is determined by the appropriate MS-DOS command.

Firmware Update

New firmware versions can be installed from the integral disk drive. The firmware update kit contains several disks. The installation program is called in the *SETUP* menu.

CONFIGURATION SETUP sidemenu:

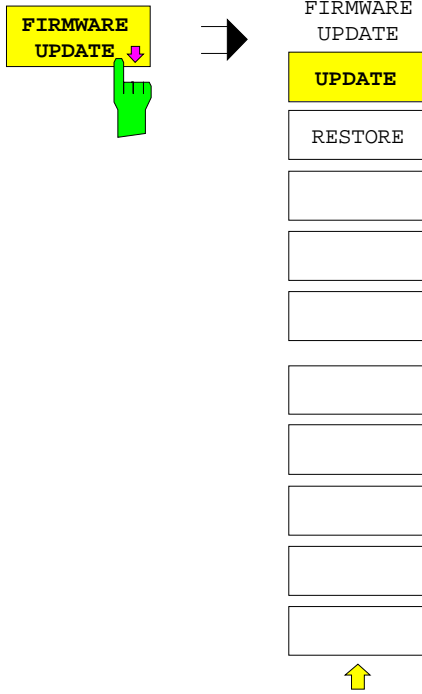

The *FIRMWARE UPDATE* softkey opens the submenu for the installation of a new firmware version.

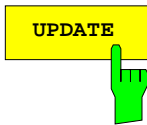

The *UPDATE* softkey starts the installation program and guides the user through the remaining steps of the update procedure.



The *RESTORE* softkey restores the previous firmware version

Status Display-Remote/Manual Control – *STATUS* Key Group

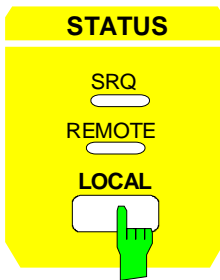

The *SRQ* LED, the *REMOTE* LED and the *LOCAL* key are contained in the *STATUS* key group.

- The *SRQ* LED indicates that a service request from the instrument has been asserted on the IEC Bus.
- The *REMOTE* LED indicates that the instrument is under remote control.
- The *LOCAL* key switches the instrument from remote to manual control, with the assumption that the remote controller has not previously set the LOCAL LOCKOUT function.

A change in the control mode comprises:

- **Enabling the Front Panel Keys**

Under remote control, the softkey menu is turned off and all keys, with the exception of *PRESET* and *LOCAL*, are disabled. Returning to manual mode enables all disabled keys. The main menu of the current mode is selected as the softkey menu..

- **Turning off the *REMOTE* LED**

- **Generating the message *OPERATION COMPLETE***

If the synchronization via **OPC*, **OPC?* or **WAI* is active when the *LOCAL* softkey is pressed, any measurement procedure that is running is aborted and synchronization is achieved by setting the corresponding bits in the registers of the status reporting system.

- **Setting Bit 6 (User Request) of the Event Status Register**

If the status reporting system is configured appropriately, setting this bit immediately elicits a service request (*SRQ*) which is used to inform the controller that the user wishes to return to front-panel control. This information can be used, e.g., to interrupt the control program so that the user can make the necessary manual corrections to instrument settings. This bit is set each time the *LOCAL* key is pressed.

- The *LOCAL* key aborts a running macro. The continuation of the macro is not possible.

IEC/IEEE-bus command `CALL IBLOC(analyzer%)`

Measurement Documentation – *HARDCOPY* Key Group

Note: The installation of additional printer drives is described in chapter 1, section "Installation and Configuration of Printers".

Printing Data – *START* Key - with Windows NT Controller

Note: Printing data for instruments with MS DOS controller or without controller is described page 4.52

The instrument uses the printer function of Windows NT to output hardcopies. Any printer supported by Windows NT can be used. In addition, the instrument permits data output in the usual data formats WMF, EWMF and BMP which enable hardcopies to be directly inserted into other documents. Network printers can be used if the instrument is connected to a network.

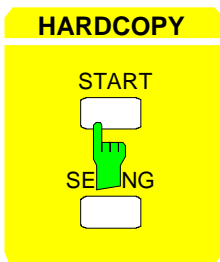

The *START* key initiates the printing of measurement/ instrument status data. The instrument can distinguish between two different printers, each of which may be individually configured, e.g., a laser printer and a ink jet printer. All documents are printed on the printer which is currently active.

IEC/IEEE-bus command :HCOPY[:IMMEDIATE<1 | 2>]

Pressing the *HARDCOPY START* key starts the print job. The settings under Windows NT and in the *HARDCOPY SETTINGS* menu determine the printer configuration. All of the display items to be printed out are written to the printer buffer of Windows NT. Since the printer runs in the background, the instrument may be operated immediately after pressing the *START* key.

When *COPY SCREEN* is selected in menu *HARDCOPY SETTINGS*, all the measurement diagrams with traces and status displays are printed as they appear on the screen. Softkeys, open tables and data entry fields are not printed out. Specific traces can be printed out with the *COPY TRACE* function. With *COPY TABLE*, tables can be printed out.

If *CLIPBOARD* is active in the *HARDCOPY DEVICE* submenu the clipboard can be used to directly transfer hardcopies to Windows applications. The copy is written in the clipboard by pressing *HARDCOPY START*. The user can then change to another Word document and insert the clipboard content into the document with EDIT - PASTE by using the key combination CTRL+V.

If the *PRINT TO FILE* option in the *HARDCOPY DEVICE* submenu is selected, the printout is directed to a file. When the *HARDCOPY START* is pressed, the file name to which the output data are to be written is requested.

If the *START* key is pressed while printing is in progress, a second output can be released which can also be joined to the printer queue. Any number of print jobs can be released consecutively.

Current print jobs can be aborted only by cancelling the entries in the Windows NT printer queue. After starting the print a printer symbol is displayed in the task bar near the time indication.



A double-click on this symbol opens a window containing the entries of the printer queue. The relevant print order can be cancelled by marking it with the mouse and pressing the DEL key.

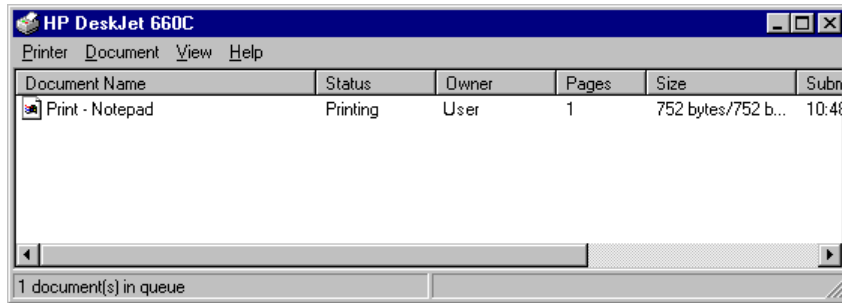

While a print job is in progress, problems may occur in the printer. If, while printing, the printer issues a PAPER OUT message, i.e., no more paper is available, the user will be prompted by the following message

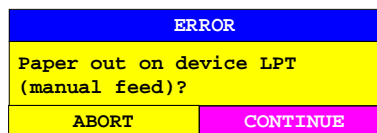

to load paper into the printer. The print job will then be either continued (CONTINUE) or aborted (ABORT).

Switchover between b/w and colored printouts is possible with the *COLOR ON/OFF* softkey provided that an appropriate printer is connected. The colors of the printout correspond exactly to those on the screen, i.e. a red trace will be output in red.

To change the colors of the objects on the printout, the screen colors have to be changed in *DISPLAY-CONFIG DISPLAY* menu. One exception is the color of the background and the color of the diagrams. The output background is always white irrespective of the screen color and the diagrams are always black.

If several traces are to be output one after the other on the same sheet different colors can be chosen for each trace with the *TRC COLOR AUTO INC* softkey (Trace Color Auto Increment).

On most b/w printers, a better printout of the color screen is obtained on hardcopies if the color information is converted into gray shades. For this, the color output in menu *HARDCOPY SETTINGS* is to be activated (COLOR ON).

Printing Data – *START* Key- with MS DOS Controller or without Controller

Note: Printing data for instruments with Windows NT controller is described page 4.50

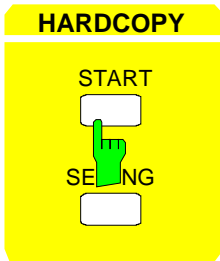

The *START* key initiates the printing of measurement/ instrument status data. The FSE can distinguish between two different output devices, each of which may be individually configured, e.g., a laser printer and a plotter. All documents are printed on the output device which is currently active.

Pressing the *HARDCOPY START* key initiates the print job. The printer parameters defined in the *HARDCOPY SETTINGS* menu are used for setting up the printer configuration. After pressing the *START* key, all of the display items to be printed are written to the printer buffer memory. Since the printer runs in the background, the instrument may be operated immediately after pressing the *START* key.

With *COPY SCREEN* selected in menu *HARDCOPY SETTINGS*, all the diagrams with traces and status displays are printed as they occur on the screen. Softkeys, open tables and data entry fields are not printed out. Function *COPY TRACE* allows to print out individual traces. With *COPY TABLE* tables can be printed out.

If the *FILE* option in the *HARDCOPY DEVICE* submenu of the *HARDCOPY SETTINGS* menu is selected then, upon pressing *HARDCOPY START*, the file name to which the output data are to be written is requested. For this an entry field is opened for entering the file name. If no external keyboard is connected, the help line editor is activated.

If the *START* key is pressed again while a print job is in progress, a new print job will be started directly after completion of the first one. It is not possible to process more than two hardcopies at the same time. With *START* pressed again, the following warning appears on the display screen:

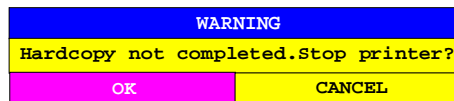

Pressing the *OK* key causes the active print jobs to be interrupted. Selecting *CANCEL* erases the warning and the print job continues.

While a print job is in progress, problems may occur in the output device. If, while printing, the output device issues a *PAPER OUT* message, i.e., no more paper is available, the user will be prompted by the following message

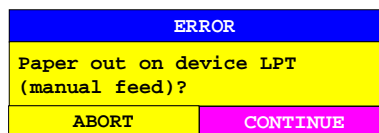

to load paper into the output device. The print job will then be either continued (*CONTINUE* selected) or aborted (*ABORT* selected).

Similar SYSTEM MESSAGES appear, e.g., if the IEC Bus address of the printer is incorrectly set , the printer does not respond, etc.

Switchover between b/w and coloured printouts is possible with softkey *COLOR ON/ OFF* provided that the printer connected is able to output such prints. The colours of the printout correspond exactly to those of the screen, ie a red trace will be output in red.

To change the colours of the objects on the printout, the screen colours have to be changed correspondingly in menu *DISPLAY*, submenu *CONFIG DISPLAY*. One exception is the colour of the background and the colour of the diagrams. The output background is always white irrespective of the screen colour and the diagrams are always black.

If several traces are to be output one after the other on the same sheet different colours can be chosen for each trace with the aid of softkey *TRC COLOR AUTO INC* (Trace Color Auto Increment).

Printing Configuration – *SETTINGS* Key

HARDCOPY SETTINGS menu:

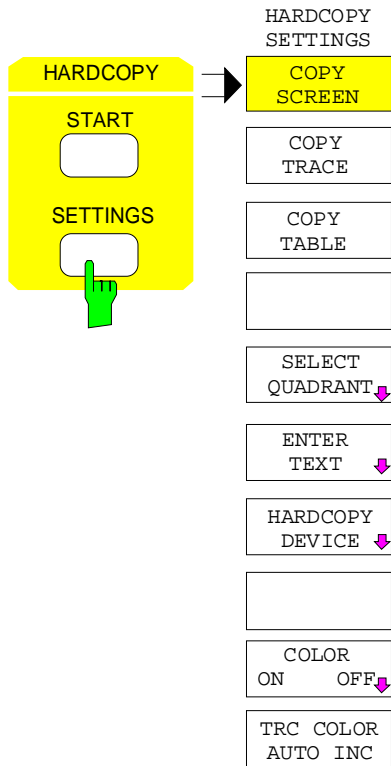

The *SETTINGS* key opens the menu to configure the printout.

The recommended procedure for configuring the printout is as follows:

- Configure the desired printer and select the interface over which the output is to take place by using Windows NT and the *HARDCOPY DEVICE* softkey.
- Select the display items to be printed with the *COPY SCREEN*, *COPY TRACE* softkeys.
- Select between coloured and b/w printouts with the *COLOR ON/ OFF* and *TRC COLOR AUTO INC* softkeys.
- Enter comment applicable to the diagram or add a title for the overall printout by using the *ENTER TEXT* softkey.
- Select the page format (*QUADRANT*, *FULL PAGE*) through use of the *SELECT QUADRANT* softkey.

The *COPY SCREEN*, *COPY TRACE* and *COPY TABLE* softkeys are selection switches, i.e., only one function can be enabled at any one time. The push buttons are used for selection only and do not initiate a print job. The actual printing is initiated by the *HARDCOPY START* key.

Selection of Displayed Elements and Colour Settings

HARDCOPY SETTINGS menu:

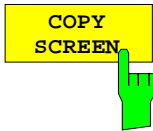

The *COPY SCREEN* softkey selects the output of test results.

All the diagrams, traces, markers, marker lists, display lines, limit lines etc. are printed out as long as they are displayed on the screen. Softkeys, tables and open data entry fields are not printed out. However, comments, title, date, and time entered are printed out at the bottom of the printout. The logo appears at the top left of the printout.

IEC/IEEE-bus command :HCOpy:ITEM:ALL

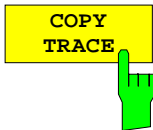

The *COPY TRACE* softkey selects the output of all traces displayed on the screen without any auxiliary information. Specifically, no markers or display lines are printed.

IEC/IEEE-bus command :HCOpy:ITEM:WINDow<1|2>:TRACe:STATe ON|OFF

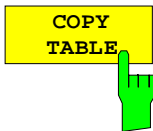

The *COPY TABLE* softkey selects the output of all tables visible displayed on the screen.

IEC/IEEE-bus command :HCOpy:ITEM:WINDow<1|2>:TABLe:STATe ON|OFF

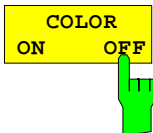

The *COLOR ON/OFF* softkey selects a coloured or b/w printout.

After having changed the printer driver or the hardcopy device (in submenu, *HARDCOPY SETTINGS*) the softkey is automatically switched to *ON*. One exception is printer driver HP PCL4 which only supports b/w printouts. In this case, the softkey cannot be operated.

IEC/IEEE-bus command :HCOpy:DEvIce:COLOr ON | OFF

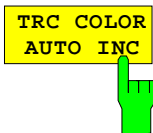

The *TRC COLOR AUTO INC* softkey automatically switches the colours of the traces on to the next printout. On the second printout, trace 1 has the colour of trace 2, trace 2 the colour of trace 3 etc. The fourth printout starts with the first colour. With the softkey switched off, the colours of the traces are reset to their original state.

When changing the printer driver or the hardcopy device (both in submenu *HARDCOPY SETTINGS*) as well as the selection b/w printout (softkey *COLOR ON/OFF* in position *OFF*), softkey *TRC COLOR AUTO INC* is switched off.

IEC/IEEE-bus command :HCOpy:ITEM:WINDow<1|2>:TRACe:CAINcrement ON | OFF

Selection of Hardcopy Format

HARDCOPY SETTINGS-SELECT QUADRANT submenu:

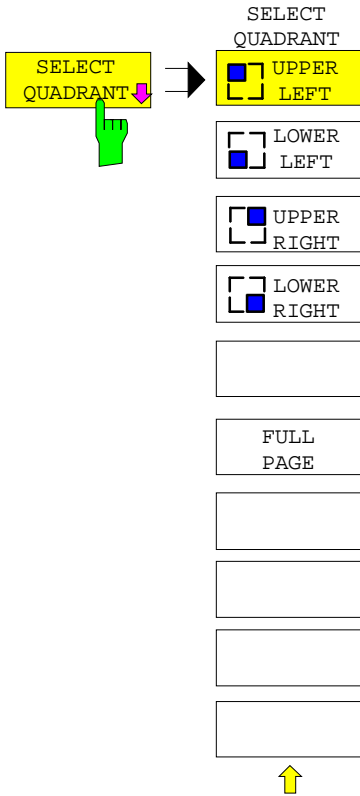

The *SELECT QUADRANT* softkey calls the the submenu for selection of *QUADRANT*the location of the display screen graphics on the printed page.

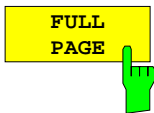

The *FULL PAGE* softkey switches quadrant printing off, i.e., printing now takes place at full size. The information as to which quadrant was last selected is also lost. *FULL PAGE* is the default setting.

IEC/IEEE-bus command :HCOPY:PAGE:DIMensions:FULL

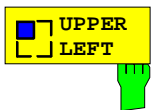

The *UPPER LEFT*, *LOWER LEFT* as well as *UPPER RIGHT*, *LOWER RIGHT* softkeys select the page quadrants where the printed data will be positioned. In this case, the actual size of the data printed on the page is reduced to 25% of normal size. This reduction is independent of how the graphics are distributed on the display screen. Thus, for two measurement windows (*SPLIT SCREEN*), both measurement diagrams shown on the display are placed in the chosen quadrant. Thus, up to a maximum of 8 measurement windows can be printed on one page. (4 print commands for a *SPLIT SCREEN* display, each to a different quadrant)

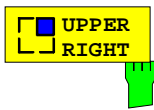
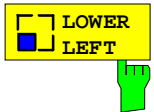

IEC/IEEE-bus command :HCOPY:PAGE:DIMensions:QUADrant 1|2|3|4

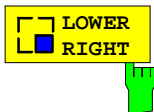

Entry of Comment Text

HARDCOPY SETTINGS-ENTER TEXT submenu:



The *ENTER TEXT* softkey calls the submenu for editing the commentary for the individual windows. The comment text appears in the print-out, but does not appear on the display screen.

If a comment is not to appear on the printout, it has to be deleted. By pressing *PRESET*, all comments will be deleted.

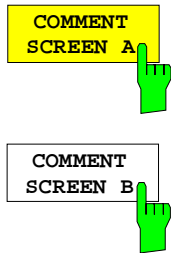

The *COMMENT SCREEN A* softkey opens an entry field in which a comment of at most two lines (60 characters per line) can be entered for screen A or screen B. If the user enters more than 60 characters, the overflow characters appear on the second line on the print-out. At any point, a manual line-feed can be forced by entering the @ character. The comment is printed below the corresponding screen.

IEC/IEEE-bus command
`:HCOPY:ITEM:WINDOW<1|2>:TEXT <string>`



The *TITLE* softkey activates a single line entry box for entering a title for the complete print-out with a maximum of 60 characters.

IEC/IEEE-bus command
`:HCOPY:ITEM:LABEL:TEXT <string>`

Selection and Configuration of the Printer - with Windows NT Controller

Note: Selection and configuration of the printer for instruments with MS DOS controller or without controller is described page 4.60

The instrument permits two different printers to be configured. One of the devices is defined as the active device and can be used for hardcopies.

The printers are mainly installed and configured under Windows NT and and the settings are valid for all Windows applications (see Chapter 1, section "Connecting an Printer"). The active device and the settings which concern only the output of hardcopies are selected in menu *HARDCOPY DEVICE*..

HARDCOPY SETTINGS submenu:

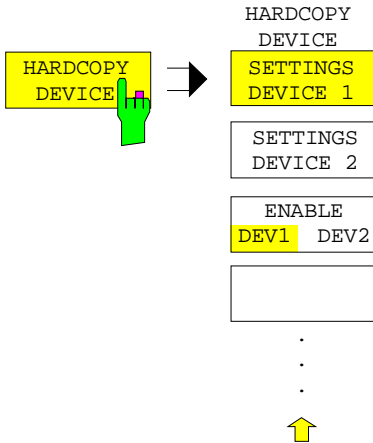

The *HARDCOPY DEVICE* softkey switches to the submenu which is used for the selection/configuration of the two printers.

When the sub-menu is called, the corresponding table is displayed. The *SETTINGS DEVICE 1* softkey is active and the selection bar is located at the *DEVICE1* line in the corresponding column of the table.

| HARDCOPY DEVICE SETTINGS | |
|--------------------------|------------------|
| Device1 | WINDOWS METAFILE |
| Print to File | YES |
| Orientation | --- |
| Device2 | CLIPBOARD |
| Print to File | --- |
| Orientation | --- |

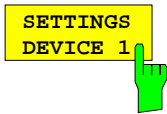

The *SETTINGS DEVICE 1* softkey permits the selection and configuration of the printer *DEVICE 1*. The *SETTINGS DEVICE 2* softkey is used to configure *DEVICE 2*.

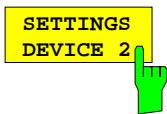

The actual selection of the active printer takes place with the *ENABLE DEV1 DEV2* softkey in the *HARDCOPY DEVICE* sub-menu.

Device

The selection of the printer/language for *DEVICE 1* and *DEVICE 2* is made in this line.

| HARDCOPY DEVICE SETTINGS | |
|--------------------------|------------------|
| Device1 | WINDOWS METAFILE |
| Print to File | YES |
| Orientation | --- |
| Device2 | CLIPBOARD |
| Print to File | --- |
| Orientation | --- |

| DEVICE |
|-------------------|
| ✓ CLIPBOARD |
| WINDOWS METAFILE |
| ENHANCED METAFILE |
| BITMAP FILE |
| HP DeskJet 660C |

Three file formats and the Windows NT clipboard are always available, even if a printer has not yet been installed under Windows NT. All installed printers are listed below in alphabetic order.

The printer installation is described in Chapter 1, Section "Installation and Configuration of Printers".

CLIPBOARD The hardcopies are copied to the Windows NT clipboard. This permits to obtain a printout of high quality which can be directly inserted into other Windows applications (menu EDIT | PASTE or key combination CTRL+V). The lines 'Print to File', 'Orientation' and 'GPIB Address' are deactivated.

WINDOWS METAFILE and ENHANCED METAFILE

WMF and EWMF are vector graphics formats which can be imported by most graphics and editing programs. EMF is recommended for recent Windows32 applications.

BITMAP FILE BMP is a bitmap format which can also be imported by most programs.

When WMF, EWMF and BMP are selected, the line "Print to File" is automatically set to ON and line "Orientation" deactivated.

IEC/IEEE-bus commands

```
:HCOpy:DEvIce:LANGUage WMF|EWMF |BMP |GDI
:HCOpy:DESTination<1|2>
  "MMEM" | "SYST:COMM:PRIN" | "SYST:COMM:CLIP"
:HCOpy:ITEM:FFEEd<1|2>:STATE ON | OFF
```

Print to File

With "Print to File" ON, the printout is directed to a file. In this case the user is prompted to enter a file name on starting the printout.

Note: This setting is coupled to the corresponding setting under Windows NT.

```
IEC/IEEE-bus commands :HCOpy:DESTination<1|2> "MMEM"
                      :MMEMory:NAME <file_name>
```

Orientation

In this line, the print format of the output page is set to either vertical (= PORTRAIT) or horizontal (= LANDSCAPE).

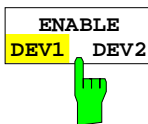

The *ENABLE DEV1 / DEV2* softkey determines the active printer. The default printer is DEVICE 1, i.e., all output takes place on DEVICE 1.

IEC/IEEE-bus command -- (The numeric suffix after HCOpy:IMMEDIATE denotes the first or second device.)

Selection and Configuration of the Printer - with MS DOS Controller or without Controller

Note: Selection and configuration of the printer for instruments with Windows NT controller is described page 4.58

HARDCOPY SETTINGS-HARDCOPY DEVICE submenu:

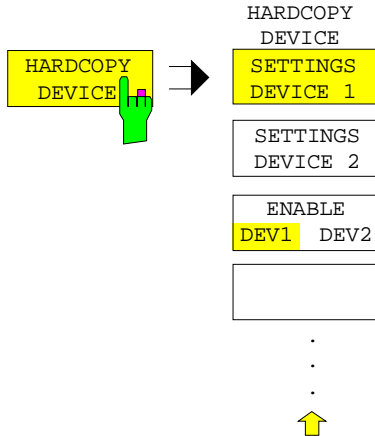

The *HARDCOPY DEVICE* softkey switches to the sub-menu which is used for the selection/configuration of the two output devices and for the connection of the devices to an output medium.

When the sub-menu is called, the corresponding table is simultaneously displayed. The *SETTINGS DEVICE 1* softkey is active and the selection bar is located at the *DEVICE/LANGUAGE* line in the corresponding column of the table.

The screenshot shows the 'HARDCOPY DEVICE' sub-menu. On the left is a table titled 'DEVICE SETTINGS'. On the right is a vertical column of softkeys. The 'SETTINGS DEVICE 1' softkey is highlighted in yellow. The 'ENABLE DEV1 DEV2' softkey is also highlighted in yellow. The 'USER' label is at the top right of the screen.

| DEVICE SETTINGS | | |
|-----------------|-------------------|-------------------|
| ITEM | SETTINGS DEVICE 1 | SETTINGS DEVICE 2 |
| Device/Language | HPGL | POSTSCR |
| Connection | GPIB1 | LPT |
| GPIB Address | 4 | --- |
| Orientation | PORTRAIT | LANDSCAPE |
| Device Reset | OFF | OFF |
| Formfeed | OFF | ON |
| Paperfeed | MANUAL | MANUAL |

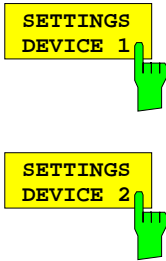

The FSE permits two different output devices to be configured. One of the devices is defined as the active device and can be used for hardcopies.

After calling the menu, the *SETTINGS DEVICE 1* softkey is active and permits the selection and configuration of the output device DEVICE 1. The selection bar is placed the corresponding column of the table. The *SETTINGS DEVICE 2* softkey is used to configure DEVICE 2.

The actual selection of the active output device takes place with the *ENABLE DEV1 DEV2* softkey in the *HARDCOPY DEVICE* sub-menu.

Device/Language

The selection of the output device/language for DEVICE 1 and DEVICE 2 is made in this line.

| DEVICE SETTINGS | | | | | | | | | | | | | | | | | | | | |
|-----------------|-------------------|--|---------------|--|----------|--|---------|--|----------|--|---------|--|---------|--|--------|--|----------|--|--------|--|
| ITEM | SETTINGS DEVICE 1 | SETTINGS DEVICE 2 | | | | | | | | | | | | | | | | | | |
| Device/Language | HPGL | <table border="1"> <thead> <tr> <th colspan="2">SELECT DEVICE</th> </tr> </thead> <tbody> <tr> <td>DESKJC3H</td> <td></td> </tr> <tr> <td>DESKJ_C</td> <td></td> </tr> <tr> <td>DESKJ_CH</td> <td></td> </tr> <tr> <td>DESKJ_H</td> <td></td> </tr> <tr> <td>EPSON24</td> <td></td> </tr> <tr> <td>HP7470</td> <td></td> </tr> <tr> <td>HP7470LS</td> <td></td> </tr> <tr> <td>✓ HPGL</td> <td></td> </tr> </tbody> </table> | SELECT DEVICE | | DESKJC3H | | DESKJ_C | | DESKJ_CH | | DESKJ_H | | EPSON24 | | HP7470 | | HP7470LS | | ✓ HPGL | |
| SELECT DEVICE | | | | | | | | | | | | | | | | | | | | |
| DESKJC3H | | | | | | | | | | | | | | | | | | | | |
| DESKJ_C | | | | | | | | | | | | | | | | | | | | |
| DESKJ_CH | | | | | | | | | | | | | | | | | | | | |
| DESKJ_H | | | | | | | | | | | | | | | | | | | | |
| EPSON24 | | | | | | | | | | | | | | | | | | | | |
| HP7470 | | | | | | | | | | | | | | | | | | | | |
| HP7470LS | | | | | | | | | | | | | | | | | | | | |
| ✓ HPGL | | | | | | | | | | | | | | | | | | | | |
| Connection | GPIB1 | | | | | | | | | | | | | | | | | | | |
| GPIB Address | 4 | | | | | | | | | | | | | | | | | | | |
| Orientation | PORTRAIT | | | | | | | | | | | | | | | | | | | |
| Device Reset | OFF | | | | | | | | | | | | | | | | | | | |
| Formfeed | OFF | | | | | | | | | | | | | | | | | | | |
| Paperfeed | MANUAL | | | | | | | | | | | | | | | | | | | |

Sequence, number and name of available devices depends on the driver files stored on the harddisk:

Data format for printout on a plotter

- HPGL standard HPGL format
- HPGL_LS output of the traces with variable Line_styles
- HP7470 plotter hp7470 (reduced HPGL format)
- HP7470LS special HP7470format allowing output of the traces with variable Line_styles

Data format for HP-deskjet series

- DESKJ black/white
- DESKJ_H black/white, high resolution
- DESKJC3: Color (3 color cartridges only) e. g. Deskjet 500)
- DESKJC3H: Color (3 color cartridges only), high resolution
- DESKJ_C: Color (3 color cartridges + black cartridge)
e. g. Deskjet 560)

- DESKJ_CH: Color (3 color cartridges + black cartridge) , high resolution

Data format for a 24-pin printer

- EPSON24 data format for Epson-compatible 24-needle printers, black/white, e. g. Epson LQ-series, R&S PDN
- EPSON24C data format for Epson-compatible 24-needle color printers, e. g. Epson Stylus Color, R&S PDN Color

Data formats for laser and ink-jet printers

- HPPCL4 black/white with 300DPI resolution
- HPPCL4HI black/white, high resolution
- HPPCL5 black/white with 300DPI resolution
- LASERJ data format for HP-laserjet starting with series III
- PCL4 black/white
- PCL4_H black/white, high resolution
- PCL4_C color (3 color cartridges + black cartridge)
- PCL4_CH color (3 color cartridges + black cartridge), high resolution
- PCL4_C3 color (3 color cartridges only)
- PCL4_C3H color (3 color cartridges only) , high resolution

Data format PostScript

- POSTSCR a printer language (PostScript)

Data formats for output files

- WMF WINDOWS Metafile format
- PCX pixel graphics (e. g. Paintbrush)

IEC/IEEE-bus command :HCOPY:DEVIce:LANGUage<1|2>
 HPGL | PCL4 | PCL5 | POSTscript |
 ESCP | WMF | PCX | HP7470 | EPSON24 |
 EPSON24C | PCL4_C | PCL4_C3 |
 LASERJ | DESKJ | DESKJ_C |
 DESKJ_C3 | HPGL_LS |
 HP7470LS | GDI | EWMF | BMP
 :HCOPY:DEVIce:RESolution<1|2> 150|300
 (only for PCL4 and HP deskjet formats)

Connection

The output channel to which the output device is connected is defined in this line.

| DEVICE SETTINGS | | |
|-----------------|-------------------|-------------------|
| ITEM | SETTINGS DEVICE 1 | SETTINGS DEVICE 2 |
| Device/Language | HPGL | POSTSCR |
| Connection | GPIB1 | LPT |
| GPIB Address | 4 | |
| Orientation | PORTRAIT | |
| Device Reset | OFF | |
| Formfeed | OFF | |
| Paperfeed | MANUAL | |

| CONNECTION | |
|---|--|
| COM1 | |
| COM2 | |
| LPT | |
| <input checked="" type="checkbox"/> GPIB1 | |
| FILE | |

By selection of the *FILE* channel, the printer output can be sent to a file. In this case, pressing *HARDCOPY START* results in a prompt for the entry of a file name.

If COM1 or COM2 is selected, recording must be set to *HARDCOPY (CONFIGURATION SETUP - GENERAL SETUP* submenu).

Output channels which, at first glance, do not appear to make sense, are also permitted because, in some cases, adapters are available which allow these devices to be connected to the interface. For example, adapters for RS232 ↔ IECBUS are available.

```
IEC/IEEE-bus command :HCOPY:DESTination<1|2>
                      'SYST:COMM:GPIB' | 'SYST:COMM:SER1' |
                      'SYST:COMM:SER2' | 'SYST:COMM:CENT' |
                      'MMEM'
```

```
Print to file:        :HCOPY:DESTination<1|2> "MMEM"
                      :MMEMory:NAME <file_name>
```

GPIB Address

The IEC Bus address of the output device is set in this line .

| DEVICE SETTINGS | | |
|----------------------------|-------------------|-------------------|
| ITEM | SETTINGS DEVICE 1 | SETTINGS DEVICE 2 |
| Device/Language Connection | HPGL GPIB1 | POSTSCR LPT |
| GPIB Address | 4 | |
| Orientation | PORTRAIT | |
| Device Reset | OFF | |
| Formfeed | OFF | |
| Paperfeed | MANUAL | MANUAL |

GPIB ADDRESS

4

Range: 0..30

The entry field in the GPIB line can only be opened when GPIB 1 was selected as an output channel in the connection line. Otherwise, this field is blank and can not be reached with the cursor keys.

```
IEC/IEEE-bus command :SYSTem:COMMunicate:GPIB:RDEvice<1|2>:ADDRESS 0...30
```

Orientation

In this line, the print format of the output page is set to either vertical (= *PORTRAIT*) or horizontal (= *LANDSCAPE*).

| DEVICE SETTINGS | | |
|----------------------------|-------------------|-------------------|
| ITEM | SETTINGS DEVICE 1 | SETTINGS DEVICE 2 |
| Device/Language Connection | HPGL GPIB1 | POSTSCR LPT |
| GPIB Address | 4 | --- |
| Orientation | PORTRAIT | LANDSCAPE |
| Device Reset | OFF | |
| Formfeed | OFF | |
| Paperfeed | MANUAL | |

ORIENTATION

✓ PORTRAIT

LANDSCAPE

```
IEC/IEEE-bus command :HCOPY:PAGE:ORientation<1|2> LANDscape | PORTrait
```

Device Reset

This line defines if the output device is to be reset (*DEVICE RESET ON*) before the actual print job is started or not (*DEVICE RESET OFF*). Resetting the output device causes, e.g., the loss of any settings which are made directly on the output device. For example, the definition of the drawing range for plotters or the print resolution for printers. The default setting at delivery is, therefore, *DEVICE RESET OFF*.

| DEVICE SETTINGS | | |
|---|--------------------|---|
| ITEM | SETTINGS DEVICE 1 | SETTINGS DEVICE 2 |
| Device/Language Connection GPIB Address | HPGL GPIB1 4 | POSTSCR LPT --- |
| Orientation | PORTRAIT | LANDSCAPE |
| Device Reset | OFF | DEVICE RESET |
| Formfeed | OFF | |
| Paperfeed | MANUAL | <input checked="" type="checkbox"/> OFF |
| | | ON |

IEC/IEEE-bus command :HCOPY:DEVIce:PRESet<1|2> ON | OFF

Formfeed

This line of the table determines whether a formfeed is made (*FORMFEED ON*) at the completion of the print job or not (*FORMFEED OFF*). The entry field in this line can only be selected when the output device permits a formfeed. Therefore, for plotters, it is set to OFF and cannot be changed.

| DEVICE SETTINGS | | |
|---|--------------------|---|
| ITEM | SETTINGS DEVICE 1 | SETTINGS DEVICE 2 |
| Device/Language Connection GPIB Address | HPGL GPIB1 4 | POSTSCR LPT --- |
| Orientation | PORTRAIT | LANDSCAPE |
| Device Reset | OFF | FORMFEED |
| Formfeed | OFF | |
| Paperfeed | MANUAL | <input checked="" type="checkbox"/> OFF |
| | | ON |

IEC/IEEE-bus command :HCOPY:ITEM:FFEEed<1|2>:STATE ON|OFF

Paperfeed

This line of the table determines which paper holder is to be used for the print job. The input field of this line can only be selected when the output device permits a selection between endless and single-sheet paper types. Therefore, for plotters it is set to OFF and cannot be changed.

| DEVICE SETTINGS | | |
|---|--------------------|--|
| ITEM | SETTINGS DEVICE 1 | SETTINGS DEVICE 2 |
| Device/Language Connection GPIB Address | HPGL GPIB1 4 | POSTSCR LPT --- |
| Orientation | PORTRAIT | LANDSCAPE |
| Device Reset | OFF | PAPERFEED |
| Formfeed | OFF | |
| Paperfeed | AUTO | <input checked="" type="checkbox"/> AUTO MANUAL |

MANUAL FEED implies selection of the single-sheet mode so that, after pressing *HARDCOPY START*, the print job is stopped after each page and the user is prompted by the message

| ERROR | |
|--|----------|
| Paper out on device LPT (manual feed)? | |
| ABORT | CONTINUE |

to load a new page in the output device. The print job is then either continued (CONTINUE selected) or stopped (ABORT selected).

IEC/IEEE-bus command :HCOPY:ITEM:PFEed<1|2>:STATE ON|OFF

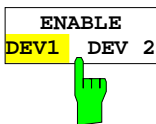

The *ENABLE DEV1 / DEV2* softkey determines the active output device. The default output device is DEVICE 1, i.e., all output takes place on DEVICE 1.

IEC/IEEE-bus command -- (the device is selected via the suffix <1|2> in HCOpy:IMMediate)

Saving and Recalling Data Sets – *MEMORY* Key Group

The keys in the *MEMORY* group call the following functions:

- Functions for managing storage media (*CONFIG*). This includes among others functions listing files, formatting storage media, copying, and deleting/rename files.
- Save/recall functions for saving (*SAVE*) settings such as instrument configurations (measurement/display settings, etc.) and saving measurement results from working memory to permanent storage media, or for recalling (*RECALL*) stored data.

The FSE can internally store complete instrument settings with instrument configurations and measurement data in the form of data-sets. The data are stored on the internal hard disk or, if required, on an external disk. The hard-disk drive and the floppy-disk drive are assigned logical names as usual in PC applications:

| | |
|------------|----|
| Disk drive | A: |
| hard disk | C: |

In addition to saving and recalling complete instrument settings, it is also possible to save/recall subsets of settings. Configuration data and measurement values are stored in separate files. These files have the same name as the data set but have a different extension. A data set therefore comprises several files which have the same name but different extensions (see Table 4-2).

When saving or recalling a data set, the subsets which are to be saved or recalled can be selected in the corresponding menus. This makes it easy to recall specific instrument settings.

When saving and recalling data via the *SAVE* and *RECALL* menus, data subsets are selected in a table in the sub-menu *SEL ITEMS TO SAVE/RECALL*. The relationship between the designations in the table and the contents of the data subsets is shown in Table 4-2

The saved data set files can be copied from one storage medium (e.g. drive C:) to another (e.g. drive A:) or to another directory using the functions found in the *MEMORY CONFIG* menu. However, do not change the file names and extensions when copying. Table 4-2 shows how extensions are assigned to data subsets..

Table 4-2 Assignment of extensions to data subsets

| | Extension | Contents | Designation in the table SEL ITEMS TO SAVE/RECALL |
|----------------------|--------------|--|---|
| Configuration data: | .SET | current settings of the measurement hardware and designation, if present | HARDWARE SETTINGS |
| | .LIN | data-point tables for the active limit lines | LINES |
| | .LIA | all defined limit lines | ALL LINES |
| | .CFG | current configuration of general instrument parameters | GENERAL SETUP |
| | .HCS | configuration for hardcopy output | HARDCOPY |
| | .TCI | tracking generator settings (only with option FSE-B8/9/10/11) | SOURCE CAL |
| | .TS1 .TS2 | settings for source calibration (only with option FSE-B8/9/10/11) | SOURCE CAL |
| | .TC1 .TC2 | correction data for source calibration (only with option FSE-B8/9/10/11) | SOURCE CAL |
| | .CL | used conversion loss (cvl) tables (only with option FSE-B21, External Mixer Output) | USED CVL TABLES |
| | .CLA | all conversion loss (cvl) tables (only with option FSE-B21, External Mixer Output) | ALL CVL TABLES |
| | .TS | activated transducer set | TRANSDUCER |
| | .TSA | all transducer sets | ALL TRANSDUCER |
| | .TF | transducer factor | TRANSDUCER |
| | .TFA | all transducer factors | ALL TRANSDUCER |
| | .COL | user-defined color settings | COLOR SETUP |
| Measurement results: | .TR1...4 | measurement data trace 1 to trace 4 | TRACE1...4 |

Configuration of Memory – CONFIG Key

MEMORY CONFIG menu:

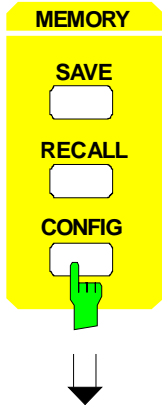

The CONFIG key opens a menu for managing storage media and files.

The *Drive Management* table displays the name and label of the storage medium as well as the free memory.

The *File Management* table displays the files in the current directory and indicates if any subdirectories are present.

If a directory name is selected, the FSE automatically changes to this directory. Selection of the entry '..' moves the FSE to the next highest directory level.

Note: It is not possible to change menus as long as a file operation is running.

The screenshot shows the FSE interface with a pink border. At the top, there is a yellow 'DRIVE MANAGEMENT' table with the following data:

| DRIVE: | HARDDISK C: | LABEL: | FREE MEM: 394:510.336 |
|--------|-------------|--------|-----------------------|
| | | | |

Below this is a blue 'FILE MANAGEMENT' table with the following data:

| FILE NAME | DATE | TIME | SIZE |
|--------------|-----------|----------|-------------|
| .. | | | |
| SETTING1.DRW | 10.MAY.93 | 10:25:18 | 68.175 kB |
| SETTING2.DRW | 15.MAY.93 | 13:08:27 | 73.283 kB |
| SETTING3.DRW | 17.MAY.93 | 08:15:21 | 174.315 kB |
| SETTING4.DRW | 28.MAY.93 | 17:05:42 | 1.236812 MB |

To the right of the tables is a vertical list of softkey options: MEMORY CONFIG, EDIT PATH, COPY, DELETE, RENAME, MAKE DIRECTORY, SORT MODE, PAGE UP, and PAGE DOWN. Further to the right are several empty rectangular boxes, with arrows indicating that the softkey options are mapped to these boxes. At the bottom right, there are four navigation arrows: up, right, left, and down.

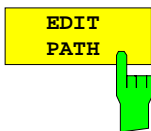

The *EDIT PATH* softkey activates the entry of the directory which will be used for subsequent file operations.

The new path is included in the *FILE MANAGEMENT* table.

IEC/IEEE-bus commands :MMEemory:MSIS 'C:\'
:MMEemory:CDIRectory 'C:\user\data'

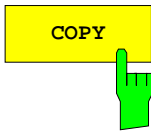

The *COPY* softkey activates the entry of the destination for the copy operation.

By prefixing a disk drive letter (e.g. C:), a file can also be copied to another storage medium. When the *ENTER* key is pressed, the selected files/directories are copied.

IEC/IEEE-bus command
 :MMEMoRY:COpy 'C:\user\data\setup.cfg', 'A:'

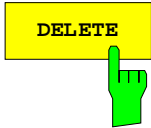

The *DELETE* softkey deletes the selected files. To prevent accidental deletion of data, confirmation by the user is requested.

IEC/IEEE-bus command :MMEMoRY:DELeTe 'TEST01.HCP'
 :MMEMoRY:RDIREctory 'C:\test'

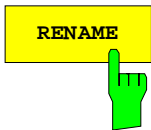

The *RENAME* softkey activates the entry of a new name for the selected file or directory.

IEC/IEEE-bus command
 :MMEMoRY:MOVe 'TEST.CFG', 'SETUP.CFG'



The *MAKE DIRECTORY* softkey creates directories/sub-directories. The use of sub-directories is recommended as a way of structuring the storage medium to make it easier to navigate.

When entering a subdirectory, entry of an absolute path name (e.g.; "\USER\MEAS") as well as the path relative to the current directory (e.g., "..\MEAS") is possible.

IEC/IEEE-bus command :MMEMoRY:MDIREctory 'C:\user\data'

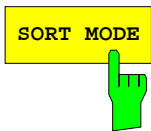

The *SORT MODE* softkey activates the selection of the sort criteria for the files listed in the *FILE MANAGEMENT* table.

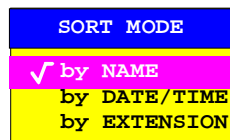

Directory names are at the top of the list after the entry for the next highest directory level ("..").

IEC/IEEE-bus command --

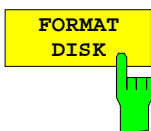

The *FORMAT DISK* softkey formats disks located in drive A:. To prevent accidental destruction of disks data, confirmation by the user is requested.

IEC/IEEE-bus command :MMEMoRY:INITialize <msus>

Saving Data Sets – SAVE Key

The *SAVE* key activates a menu which contains all functions necessary for saving instrument data.

- Entry of the name of the data set which should be saved. Confirmation of the entry initiates a save operation to store the data set.

Data set names may contain both alphabetical and numeric characters, in the simplest case only numbers. The simplest example for the input of a data set name is illustrated by the following key strokes:

<SAVE> <1> <units key>

- Entry of the directory in which the data set should be saved
- Input of data set description
- Selection of the data subsets to be saved (sub-menu SEL ITEMS TO SAVE)
- Indication of all available data sets
- Deletion of all available data sets

MEMORY SAVE menu



The *SAVE DATA SET* table shows the current settings regarding the data set:

| | |
|----------------|--|
| <i>Name</i> | Name of data set |
| <i>Path</i> | Directory in which the data set will be saved |
| <i>Items</i> | Indicates whether the default selection of data subsets (DEFAULT) or a user-defined selection (SELECTED) will be saved |
| <i>Comment</i> | Comments about the data set |

The *EDIT NAME* softkey for entering the name of the data set to be saved is activated automatically.

Selecting the Data Set for Saving

MEMORY SAVE menu:

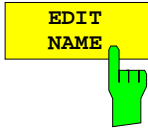

The *EDIT NAME* softkey activates the entry of the name of the data set to be saved.

Data entry is concluded by pressing one of the units keys which initiates a save operation to store the data set.

IEC/IEEE-bus command :MMEMory:STORe:STATe 1,'test'

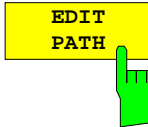

The *EDIT PATH* softkey activates the input of a directory name where the data sets are to be stored. Default path is c:\user\config.

IEC/IEEE-bus command --

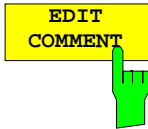

The *EDIT COMMENT* softkey activates the entry of comments for the current data set. A total of 60 characters are available for this purpose.

IEC/IEEE-bus command :MMEMory:COMMeNt <string>



The *DATA SET LIST* softkey opens the *DATA SET LIST/CONTENTS* table. The *DATA SET CLEAR* and *DATA SET CLEAR ALL* softkeys are also displayed.

The *DATA SET LIST* column lists all the data sets which are stored in the selected directory.

The *CONTENTS* and *COMMENT* lines in the *DATA SET CONTENTS* column indicate the saved data subsets and the comments for the currently selected data set.

IEC/IEEE-bus command --

Note: *The current instrument configuration can be easily stored under the name of an existing data set:*

- *Press a units key after selecting a data set*

The name and the selection of the data subsets for the currently selected data set will be placed in the SAVE DATA SET table. The DATA SET LIST table is closed and, instead, the entry field for the EDIT NAME function with the name of the selected data set is opened.

- *Press a units key.*

The current instrument configuration is saved as a data set under this name.

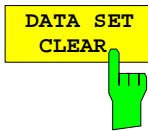

The *DATA SET CLEAR* softkey clears the marked data set.

IEC/IEEE-bus command :MMEMoRY:CLEAr:STATe 1, 'test'

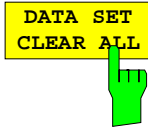

The *DATA SET CLEAR ALL* softkey deletes all data sets in the current directory.

To prevent all the data sets from being accidentally lost, confirmation from the user is required before actual clearing takes place.

IEC/IEEE-bus command :MMEMoRY:CLEAr:ALL

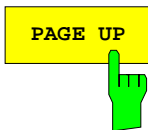

The *PAGE UP* or *PAGE DOWN* softkey sets the *DATA SET LIST* table to the next or previous page.

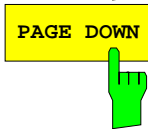

Selecting the Data subset for Storage

MEMORY SAVE-SELECT ITEMS TO SAVE sub-menu:

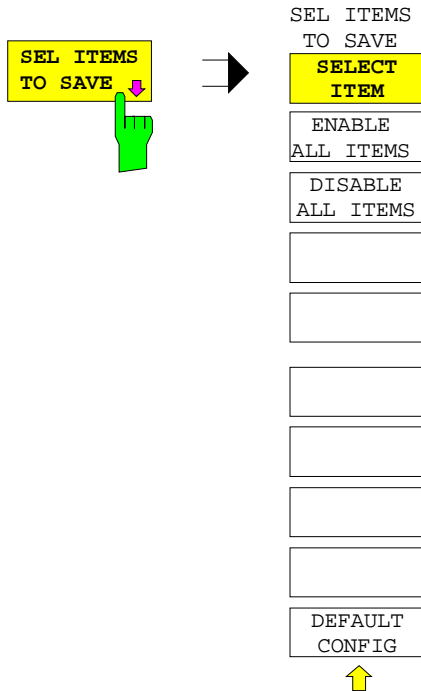

The *SEL ITEMS TO SAVE* softkey opens a sub-menu for selection of the data subsets.

The *ITEMS TO SAVE* table displays the selectable data subsets:

| ITEMS TO SAVE | |
|-----------------------|----------------------|
| GENERAL SETUP | ✓ COLOR SETUP |
| ✓ HW-SETTINGS | ✓ HARDCOPY |
| TRACE 1 | |
| TRACE 2 | MACROS |
| TRACE 3 | |
| TRACE 4 | |
| ✓ ACTIVE LINES | ACTIVE TRANSDUCER |
| ALL LINES | ALL TRANSDUCER |
| USED CVL TABLES | |
| ALL CVL TABLES | |

- General Setup* current configuration of general instrument parameters
- HW-Settings* current measurement hardware settings
- Trace1...4* measurement data trace 1 to trace 4
- Active Lines* active limit lines
- All Lines* all limit lines
- Used CVL Tables* activated conversion loss tables
- All CVL Tables* all conversion loss tables
- Color Setup* user-defined color settings
- Hardcopy Setup* configuration for hardcopy output
- Macros* macros
- Active Transducer* active transducer
- All Transducer* all transducer

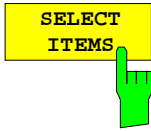

The *SELECT ITEMS* softkey moves the selection bar to the first line, left column of the table.

IEC/IEEE-bus commands

```
:MMEMory:SElect[:ITEM]:GSEtup ON|OFF
:MMEMory:SElect[:ITEM]:HWSettings ON|OFF
:MMEMory:SElect[:ITEM]:TRACe<1...4> ON|OFF
:MMEMory:SElect[:ITEM]:LINES[:ACTiVe] ON|OFF
:MMEMory:SElect[:ITEM]:LINES:ALL ON|OFF
:MMEMory:SElect[:ITEM]:CSEtup ON|OFF
:MMEMory:SElect[:ITEM]:HCOPY ON|OFF
:MMEMory:SElect[:ITEM]:CVL[:ACTiVe] ON | OFF
:MMEMory:SElect[:ITEM]:CVL:ALL ON | OFF
:MMEMory:SElect[:ITEM]:SCData ON | OFF
:MMEMory:SElect[:ITEM]:MACROs ON|OFF
:MMEMory:SElect[:ITEM]:TRANSDUCER ON|OFF
:MMEMory:SElect[:ITEM]:TRANSDUCER:ALL ON|OFF
```

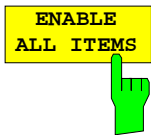

The *ENABLE ALL ITEMS* softkey marks all entries in the *ITEMS TO SAVE* table.

IEC/IEEE-bus command :MMEMory:SElect[:ITEM]:ALL



The *DISABLE ALL ITEMS* softkey unmarks all entries in the *ITEMS TO SAVE* table.

IEC/IEEE-bus command :MMEMory:SElect[:ITEM]:NONE

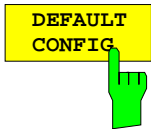

The *DEFAULT CONFIG* softkey establishes the default selection of the data subset to be saved and outputs *DEFAULT* in the *ITEMS* field of the *SAVE DATA SET* table.

IEC/IEEE-bus command :MMEMory:SElect[:ITEM]:DEFault

Recalling of Data Sets – *RECALL* Key

The *RECALL* key activates a menu which contains all functions necessary for recalling data sets.

- Entry of the name of the data set which should be recalled. Confirmation of the entry initiates a load operation to recall the data set.
- Entry of the directory in which the data set is stored
- Display of data set description
- Selection of a data set which will be automatically loaded upon power-up
- Indication of all available data sets
- Deletion of all available data sets
- Selection of the data subsets which should be loaded (configurations, measurement and calibration data, sub-menu *SEL ITEMS TO RECALL*)

Any settings not restored when data subsets are loaded will remain unchanged in the instrument. During recall operations, the FSE recognises which data subsets are present in the recalled data set and offers only the corresponding settings for selection in the *SELECT ITEM* sub-menu.

A new instrument data set can be easily constructed from several existing data sets: the desired data subsets are selected and recalled out of various data sets in several *RECALL* operations. When the desired configuration is completed, the new data set can be saved under a new name.

MEMORY RECALL menu:



The *RECALL DATA SET* table shows the current settings regarding the data set:

| | |
|----------------|---|
| <i>Name</i> | Name of data set |
| <i>Path</i> | Directory in which the data set is located |
| <i>Items</i> | Indicates whether the default selection of data subsets (DEFAULT) or a user-defined selection (SELECTED) will be loaded |
| <i>Comment</i> | Comments about the data set |

The *EDIT NAME* softkey for entering the name of the data set to be loaded is activated automatically.

Selecting the Data Set for Recalling

MEMORY RECALL menu:

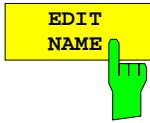

The *EDIT NAME* softkey activates the entry of a data set name. The data input is terminated by pressing one of the units keys which simultaneously initiates the data set recall operation.

IEC/IEEE-bus command :MMEMory:LOAD:STATe 1, 'A:test'

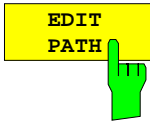

The *EDIT PATH* softkey activates the entry of a directory name in which the data set is located. Default path is c:\user\config.

IEC/IEEE-bus command --

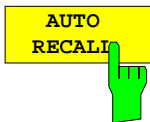

The *AUTO RECALL* softkey activates the selection of a data set which will be automatically recalled when the instrument is powered up. The *DATA SET LIST/CONTENT* table is opened to make the selection (analogous to *DATA SET LIST*).

IEC/IEEE-bus command :MMEMory:LOAD:AUTO 1, 'C:\user\data\auto'

| DATA SET LIST | AUTO RECALL SET CONTENT |
|---------------|--|
| DATASET1 | CONTENTS |
| DATASET2 | GENERAL SETUP <input checked="" type="checkbox"/> COLOR SETUP |
| DATASET3 | <input checked="" type="checkbox"/> HW-SETTINGS <input checked="" type="checkbox"/> HARDCOPY |
| | TRACE 1 |
| | TRACE 2 |
| | TRACE 3 |
| | TRACE 4 |
| | <input checked="" type="checkbox"/> LINES <input checked="" type="checkbox"/> TRANSDUCER |
| | CVL TABLES |
| | MACROS |
| | COMMENT |
| | GSM_MASK |

The *DATA SET LIST* column displays all the data sets in the selected directory.

The *CONTENTS* and *COMMENT* lines in the *AUTO RECALL CONTENTS* column indicate the saved data subsets and the comments for the currently selected data set.

In addition to the data sets saved by the user, the data set *FACTORY*, which contains the settings of the instrument before it was last switched off (Standby), is always included.

If a data set other than *FACTORY* is chosen the data subsets in the selected data set that are available are recalled when the FSE is powered up. The data subsets which are not in this data set are taken from the *FACTORY* data set.

Note: The selected data set is also loaded on *PRESET* if *AUTO RECALL* is active. The preset settings can then be configured as required.

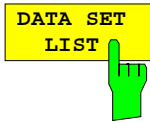

see Chapter "Saving Data Sets"

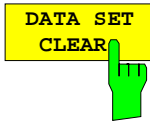

see Chapter "Saving Data Sets"

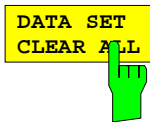

see Chapter "Saving Data Sets"

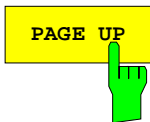

The *PAGE UP* or *PAGE DOWN* softkey sets the *DATA SET LIST* table to the next or previous page.

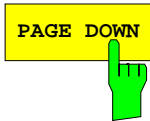

Building a Data Set

MEMORY RECALL-SELECT ITEMS TO RECALL sub-menu:

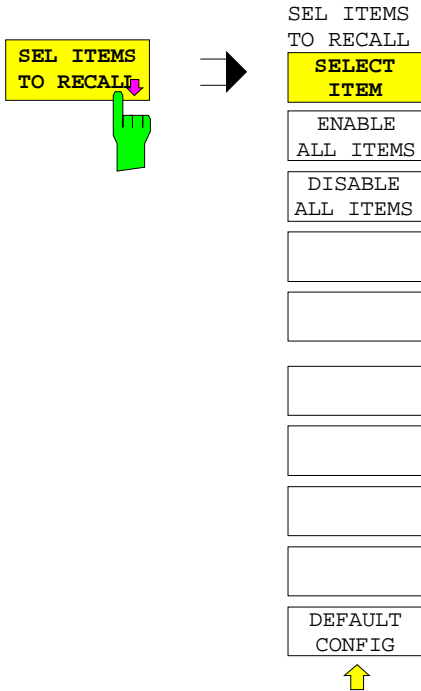

The *SEL ITEMS TO RECALL* softkey opens a sub-menu to select data subsets.

The *ITEMS TO RECALL* table displays the selectable data subsets:

| ITEMS TO RECALL | |
|-----------------|------------------|
| GENERAL SETUP | ✓ COLOR SETUP |
| ✓ HW-SETTINGS | ✓ HARDCOPY SETUP |
| TRACE 1 | MACROS |
| TRACE 2 | |
| TRACE 3 | |
| TRACE 4 | |
| ✓ LINES | ✓ TRANSDUCER |
| CVL TABLES | |

- General Setup* current configuration of general instrument parameters
- HW-Settings* current measurement hardware settings
- Trace 1...4* measurement data trace 1 to trace 4
- Lines* data point tables for the active limit lines
- CVL Tables* conversion loss tables
- Color Setup* user-defined color settings
- Hardcopy Setup* configuration for hardcopy output
- Macros* macros
- Transducer* transducer factor, transducer set

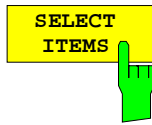

The *SELECT ITEMS* softkey activates the *ITEMS TO RECALL* table and sets the selection bar to the first line, left column of the table.

IEC/IEEE-bus command see "Selecting the Data subset for Storage"

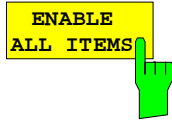

The *ENABLE ALL ITEMS* softkey marks all entries in the *ITEMS TO RECALL* table.

IEC/IEEE-bus command :MMEMory:SElect[:ITEM]:ALL

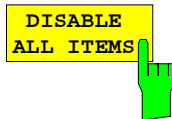

The *DISABLE ALL ITEMS* softkey unmarks all entries in the *ITEMS TO RECALL* table.

IEC/IEEE-bus command :MMEMory:SElect[:ITEM]:NONE

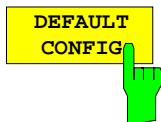

The *DEFAULT CONFIG* softkey establishes the default selection of the data subset to be recalled and outputs *DEFAULT* in the *ITEMS* field of the *RECALL DATA SET* table.

IEC/IEEE-bus command :MMEMory:SElect[:ITEM]:DEfault

Macros – USER Key

The FSE menus are so designed that the analyzer can be easily applied to most of the usual measurement tasks with a minimum number of key operations. However, the *USER* menu also permits a tailored adaptation of any necessary setup and measurement functions needed for special applications. Here, a sequence of key operations, which may occur repeatedly, can be listed in the *USER* menu as a key macro, then stored in memory and recalled as required by the application.

Fundamentals

Macros are defined as arbitrary key sequences which need to be defined only once and then can be recalled as often as desired. Through the use of macros, often-needed measurement functions or instrument setups, which may require a large number of key operations, can be easily performed. The writing of macros is possible only under manual control. Macro generation is not possible under remote control (e.g. via the IEC Bus interface) and when using a mouse.

A total of 7 different macros can be programmed and assigned to the individual softkeys of the *USER* menu. Each macro has a title (arbitrarily defined by the user) which is also used as a label for the corresponding softkey. To indicate that a macro has not yet been programmed, the softkey label appears in parenthesis (e.g. (MACRO 1)). After a key-sequence macro has been defined, the parenthesis are removed and the softkey is replaced by the title specified by the user.

A macro is executed by pressing the corresponding softkey.

During execution of macros, the key actions are repeated in exactly the **same sequence** as they were programmed. The sequential execution of a macro may be interrupted by using the PAUSE instruction. As soon as a macro is interrupted, adjustments on the Unit Under Test (UUT) may be made, etc. The interrupted macro is allowed to continue by pressing *CONTINUE* in the message window and is aborted by pressing ABORT.

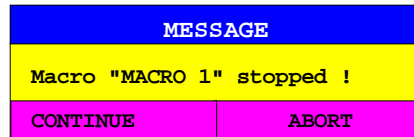

A running macro can be aborted by pressing the *LOCAL* key. At this time, the following message is displayed:

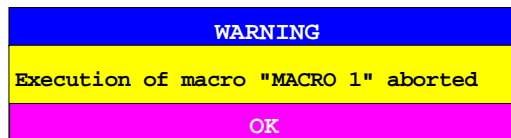

During the time a macro is executing, manual operations on the instrument are not possible, and the softkey panel is disabled. After interruption or conclusion of a macro, the applicable softkey panel is enabled (i.e., menu state at the conclusion of the macro).

Starting Macros

USER menu

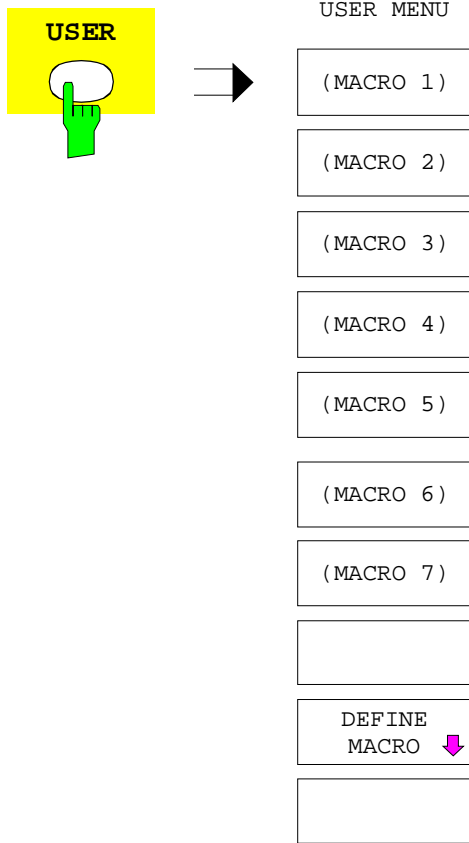

The USER key opens a menu for selection and starting of macros.

The macros can be defined in the *DEFINE MACRO* submenu.

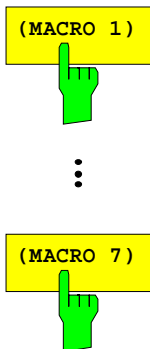

The *MACRO 1* to *7* softkeys start the execution of the macros.
IEC/IEEE-bus command --

Defining Macros

In the *DEFINE MACRO* menu, all necessary softkeys needed for macro management are available. Included are functions for starting and ending macro programming, editing of a macro title, etc.

USER DEFINE MACRO menu

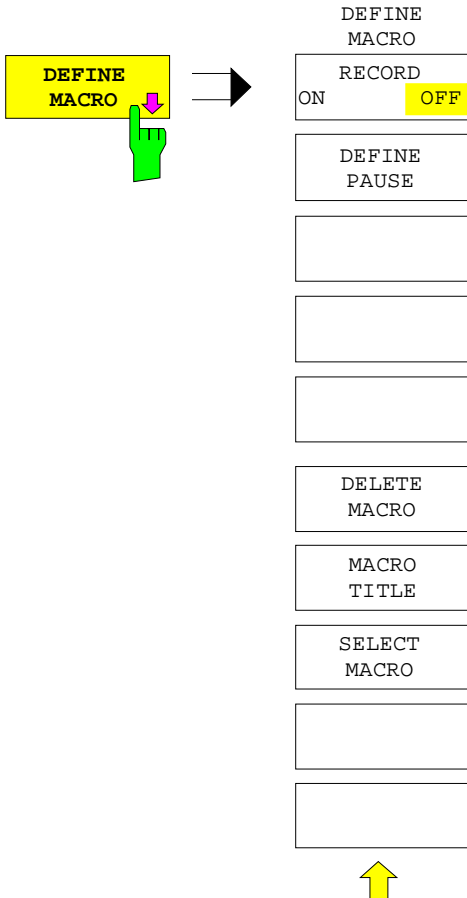

The *DEFINE MACRO* softkey calls the sub-menu to define the macros.

The *SELECT MACRO* softkey is active and opens the box to select the macro to be edited. In case no selection is made, *MACRO 1* is automatically selected.

IEC/IEEE-bus command --

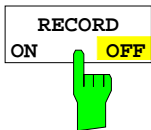

The *RECORD ON/OFF* starts or stops the recording of the macro.

ON All key actions are recorded until the softkey is changed to *OFF*. To indicate that macro record is enabled, the enhancement label **MAC** is displayed.

The number of actions which can be stored in a macro is limited. If the limit is exceeded, the error message "Macro too long. Recording aborted" is output and the recording operation is aborted, however, the actions already recorded do remain stored.

OFF The recording is stopped. The key actions are stored under the macro chosen by the *SELECT MACRO* softkey.

IEC/IEEE-bus command --

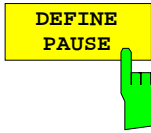

The *DEFINE PAUSE* softkey inserts a pause instruction into the macro sequence which is being recorded. A running macro will pause when it reaches this instruction, at which point settings on the unit under test could for example be made. *CONTINUE* in the message window is used to continue the macro execution.

IEC/IEEE-bus command --

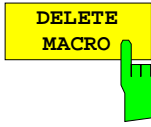

The *DELETE MACRO* softkey deletes the macro which was previously selected by the *SELECT MACRO* softkey. The softkey of the deleted title now carries its default label (*MACRO X*, X = macro number)

IEC/IEEE-bus command --

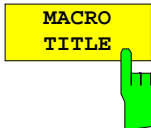

The *MACRO TITLE* softkey activates the entry of the title for the selected macro.

Because the macro title is used for labelling the corresponding softkey, a maximum of only 20 characters is allowed. All text after the 10th character is written to the second line. However, entering the character @ forces a new line at any point in the softkey title.

IEC/IEEE-bus command --

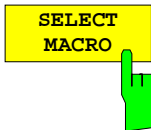

The *SELECT MACRO* softkey open the selection box with a list of all 7 macros. All softkey functions of this menu are related to this macro.

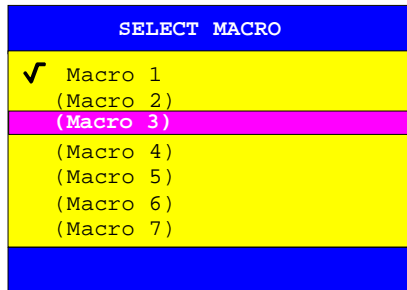

IEC/IEEE-bus command --

Analyzer Mode

Frequency and Span Selection – FREQUENCY Key Group

The *FREQUENCY* key group is used to specify the frequency axis of the active measurement window. The frequency axis can be defined either by the start and stop frequency or by the center frequency and span. For the case when two measurement windows (*SPLIT-SCREEN*) are displayed simultaneously, data entered are always related to the window selected in the *SYSTEM-DISPLAY* menu.

When one of the keys *CENTER*, *SPAN*, *START* or *STOP* is pressed, its value can be specified in an entry window. At the same time, a softkey menu appears, which allows selecting the optional parameters.

Start Frequency – START Key

FREQUENCY – *START* menu:

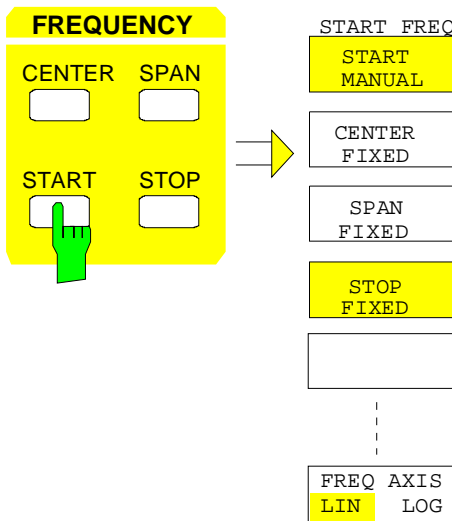

The *START* key opens a menu which displays the various options for setting the start frequency of the sweep. The *START MANUAL* softkey is automatically active and opens the entry window for manual input of the start frequency. At the same time, the coupling of the parameters is set to *STOP FIXED*

The *STOP FIXED*, *SPAN FIXED* and *CENTER FIXED* softkeys are mutually exclusive selection switches. Only one of these switches may be active at any one time. The frequency coupling selected by the softkeys defines which of the dependent parameters stop frequency, center frequency and span is to remain constant when a change in the start frequency is made.

The *FREQ AXIS LIN/LOG* softkey switches between linear and logarithmic scaling of the frequency axis.

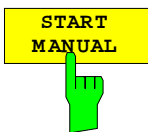

The *START MANUAL* softkey activates manual entry of the start frequency.

The allowed range of values for the start frequency is:

$$0 \text{ Hz} \leq f_{\text{start}} \leq f_{\text{max}} - \text{minspan}/2$$

f_{start} start frequency
 minspan smallest selectable span)
 f_{max} max. frequency

IEC/IEEE-bus command : [SENSE<1 | 2>:]FREQuency:STARt 20 MHz

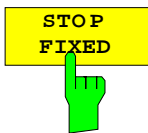

If the *STOP FIXED* key is active, the stop frequency remains constant when the start frequency is changed. The center frequency is adjusted to the new frequency range. *STOP FIXED* coupling is the default setting.

IEC/IEEE-bus command : [SENSE<1 | 2>:]FREQ:STARt:LINK STOP

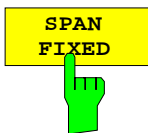

If the *SPAN FIXED* softkey is active, the span remains constant when the start frequency is changed. The stop frequency is adjusted to the new frequency range.

IEC/IEEE-bus command : [SENSE<1 | 2>:]FREQ:STARt:LINK SPAN

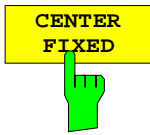

If the *CENTER FIXED* softkey is active, the center frequency remains constant when the start frequency is changed. The stop frequency is adjusted to the new frequency range.

IEC/IEEE-bus command : [SENSE<1|2>:]FREQ:START:LINK CENTER



The *FREQ AXIS LIN/LOG* softkey switches between linear and logarithmic scales on the frequency axis.

When the log scale is used, the following restrictions apply:

- For the start/stop frequency ratio the following holds:

$$\frac{\text{Stopfrequency}}{\text{Startfrequency}} \geq 1.4$$

At ratios below 1.4, a linear frequency scale is automatically selected.

- Up to five decades can be set.

$$\frac{\text{Stopfrequency}}{\text{Startfrequency}} \leq 10^5$$

When the start or stop frequency is changed, the stop or start frequency is adapted to the settable range, as required.

- A frequency offset is not allowed.
- The *CHANNEL POWER*, *C/N*, *C/N0*, *ADJACENT CHAN POWER* and *OCCUPIED PWR BANDW* measurements are disabled.

Note: *The function of a limit line is influenced by the FREQ AXIS LIN/LOG setting at the time of the definition. Limit lines are entered as tabulated values (level and frequency). Most regulations and standards prescribe the linking of values by straight lines both for the linear and logarithmic display. When the limit line is defined with the desired frequency scale selected, this is automatically taken into account (linear interpolation). To be able to use the correct limit values among the tabulated values after a scale switchover, the limit line is recalculated after the switchover.*

IEC/IEEE-bus command : [SENSE<1|2>:]SWEp:SPACing LIN | LOG

Stop Frequency – STOP Key

FREQUENCY – STOP menu:

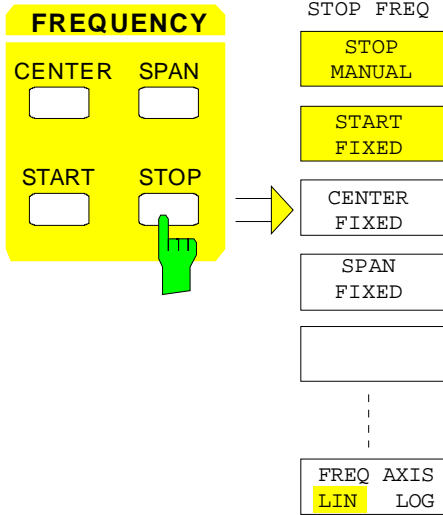

The *STOP* key opens a menu which displays the various options for setting the stop frequency of the sweep.

The *STOP MANUAL* softkey is automatically active and opens the entry window for manual input of the stop frequency. At the same time, parameter coupling is set to *START FIXED*.

The *START FIXED*, *CENTER FIXED* and *SPAN FIXED* softkeys are mutually exclusive selection switches. Only one switch can be active at any one time. The softkeys are used to select the frequency coupling. The frequency coupling defines which of the dependent parameters start frequency, center frequency or span is to remain constant when the stop frequency is changed.



The *STOP MANUAL* softkey activates the manual entry window for the stop frequency.

The allowed range of values for the stop frequency is:

$$\text{minspan} \leq f_{\text{stop}} \leq f_{\text{max}}$$

| | |
|-------------------|---------------------------------|
| f_{stop} | stop frequency |
| minspan | smallest selectable span (10Hz) |
| f_{max} | max. frequency |

IEC/IEEE-bus command : [SENSE<1|2>:]FREQuency:STOP 13 GHz

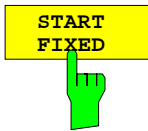

If the *START FIXED* softkey is active, the start frequency remains constant when the stop frequency is changed. The center frequency is adjusted to the new frequency range. The *START FIXED* coupling is the default setting.

IEC/IEEE-bus command : [SENSE<1|2>:]FREQ:STOP:LINK START



If the *CENTER FIXED* softkey is active, the center frequency remains constant when the stop frequency is changed. The start frequency is adjusted to the new frequency range.

IEC/IEEE-bus command : [SENSE<1|2>:]FREQ:STOP:LINK CENTER

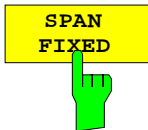

If the *SPAN FIXED* softkey is active, the span remains constant when the stop frequency is changed. The start frequency is adjusted to the new frequency range.

IEC/IEEE-bus command : [SENSE<1|2>:]FREQ:STOP:LINK SPAN



The *FREQ AXIS LIN/LOG* softkey switches between linear and logarithmic scales on the frequency axis (see *START* key).

IEC/IEEE-bus command : [SENSE<1|2>:]SWEep:SPACing LIN | LOG

Center Frequency – CENTER Key

FREQUENCY – CENTER menu:

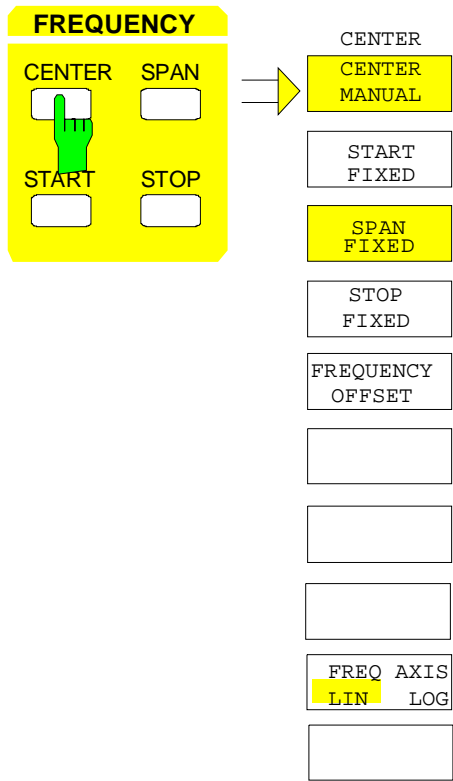

The *CENTER* softkey opens a menu which displays the various options for setting the center frequency of the sweep.

The *CENTER MANUAL* softkey is automatically active and opens the entry window for manual input of the center frequency. At the same time, the coupling of the parameters is set to *SPAN FIXED*.

The *START FIXED*, *STOP FIXED* and *SPAN FIXED* softkeys are mutually exclusive selection switches. Only one switch can be active at any one time. The softkeys are used to select the frequency coupling. The frequency coupling defines which of the dependent parameters start frequency, stop frequency or span remains constant when the center frequency is changed.



The *CENTER MANUAL* softkey opens the entry window for entering the center frequency.

The entry range for the center frequency is:

for the frequency domain (span > 0):

$$0 \text{ Hz} \leq f_{\text{center}} \leq f_{\text{max}} - \text{minspan}/2$$

and for the time domain (span = 0)

$$0 \text{ Hz} \leq f_{\text{center}} \leq f_{\text{max}}$$

- f_{center} center frequency
- minspan smallest selectable span (10Hz)
- f_{max} max. frequency

IEC/IEEE-bus command : [SENSE<1 | 2>:]FREQUENCY:CENTER 1.3 GHz

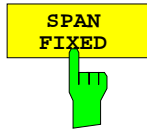

If the *SPAN FIXED* softkey is active, the span remains constant when the center frequency is changed. The start and stop frequency are adjusted to the new frequency range. *SPAN FIXED* coupling is the default setting.

IEC/IEEE-bus command : [SENSE<1|2>:]FREQ:CENTer:LINK SPAN

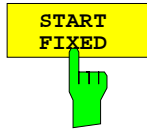

If the *START FIXED* softkey is active, the start frequency remains constant when the center frequency is changed. The span is adjusted to the new frequency range.

IEC/IEEE-bus command : [SENSE<1|2>:]FREQ:CENTer:LINK START

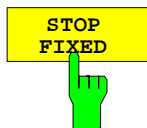

If the *STOP FIXED* softkey is active, the stop frequency remains constant when the center frequency is changed. The span is adjusted to the new frequency range.

IEC/IEEE-bus command : [SENSE<1|2>:]FREQ:CENTer:LINK STOP

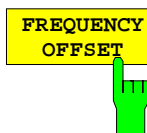

The *FREQUENCY OFFSET* softkey activates the entry of a straight frequency offset which is added to the frequency axis. The offset range is -100 GHz to 100 GHz. The default setting is 0 Hz.

IEC/IEEE-bus command : [SENSE<1|2>:]FREQ:OFFSet 10 GHz



The *FREQ AXIS LIN/LOG* softkey switches between linear and logarithmic scales on the frequency axis (see *START* key).

IEC/IEEE-bus command : [SENSE<1|2>:]SWEep:SPACing LIN | LOG

Center Frequency Step Size

The *STEP* key in the *DATA VARIATION* key group opens a menu for setting the step size of the center frequency. The step size can be coupled to the span (frequency domain) or the resolution bandwidth (time domain) or it can be manually set to a fixed value.

In order to change the step size, the entry window for the center frequency must already be active. After pressing the *STEP* key, the *CENTER STEP* menu appears. The softkeys are presented according to the selected domain (frequency or time).

Only one of the menu softkeys can be activated at any one time.

Control is returned to the *FREQUENCY CENTER* menu via the menu key .

DATA VARIATION - STEP menu for span ≠ 0 for span = 0

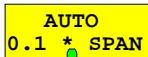
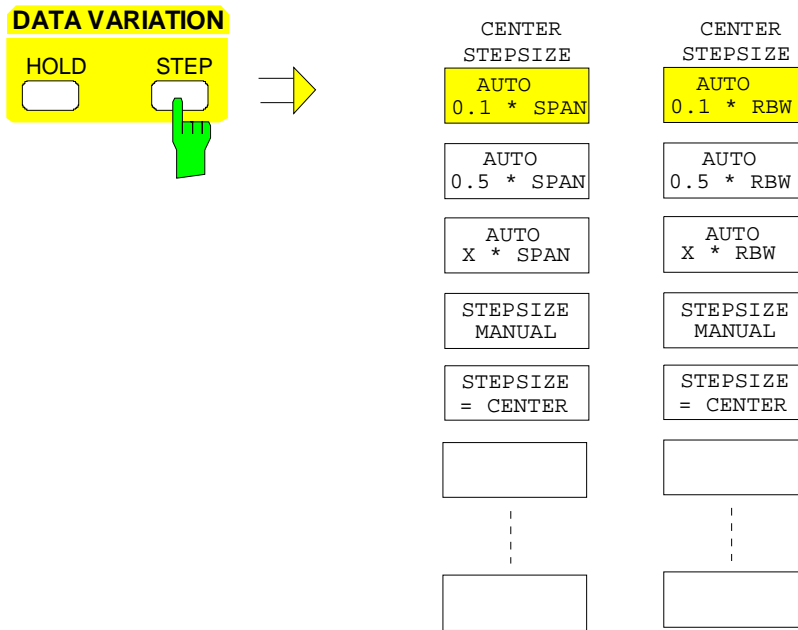

Frequency domain: The *AUTO 0.1 * SPAN* softkey sets the step size for center frequency entry to 10% of the span.

IEC/IEEE-bus command

```
:[SENSe<1 | 2>:]FREQuency:CENTer:STEP:LINK SPAN;  
:[SENSe<1 | 2>:]FREQuency:CENTer:STEP:LINK:FACTOR 10PCT
```

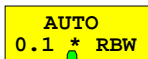

Time domain: The *AUTO 0.1 * RBW* softkey sets the step size of the center frequency entry to 10% of the resolution bandwidth

IEC/IEEE-bus command

```
:[SENSe<1 | 2>:]FREQuency:CENTer:STEP:LINK RBW;  
:[SENSe<1 | 2>:]FREQuency:CENTer:STEP:LINK:FACTOR 10PCT
```

*AUTO 0.1 * RBW* is the default setting.

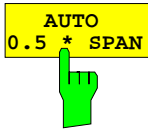

Frequency domain: The *AUTO 0.5 * SPAN* softkey sets the step size for center frequency entry to 50% of the span.

IEC/IEEE-bus command

```
:[SENSe<1|2>:]FREQuency:CENTer:STEP:LINK SPAN;  
:[SENSe<1|2>:]FREQuency:CENTer:STEP:LINK:FACTOR 50PCT
```

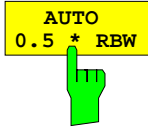

Time domain: The *AUTO 0.5 * RBW* softkey sets the step size of the center frequency entry to 50% of the resolution bandwidth

IEC/IEEE-bus command

```
:[SENSe<1|2>:]FREQuency:CENTer:STEP:LINK RBW;  
:[SENSe<1|2>:]FREQuency:CENTer:STEP:LINK:FACTOR 50PCT
```

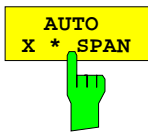

Frequency domain: The *AUTO X * SPAN* softkey activates the entry of the factor defining the center frequency step size as a % of span.

IEC/IEEE-bus command see *AUTO 0.5 * SPAN*

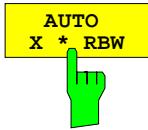

Time domain: The *AUTO X * RBW* softkey activates the entry of the factor defining the center frequency step size as a % of the resolution bandwidth.

IEC/IEEE-bus command see *AUTO 0.5 * RBW*

Values between 1 and 100% in steps of 1% are acceptable. The default setting is 10%.



The *STEPSIZE MANUAL* softkey activates the entry window for the input of a fixed step size.

IEC/IEEE-bus command

```
:[SENSe<1|2>:]FREQuency:CENTer:STEP 1.3 GHz
```

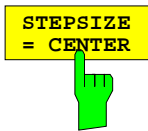

The *STEPSIZE = CENTER* softkey sets the step size coupling to *MANUAL* and the step size to the center frequency. This function is especially useful when measuring harmonics, because, when the center frequency is entered, each *STEP* key stroke selects the center frequency of the next harmonic.

IEC/IEEE-bus command --

Frequency Span – SPAN Key

FREQUENCY – SPAN menu:

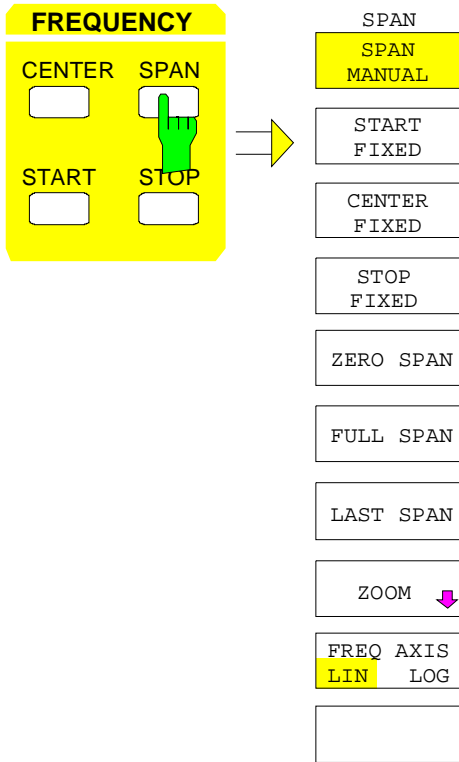

The *SPAN* key opens a menu for setting the sweep span.

The *SPAN MANUAL* softkey is automatically active and opens the entry window for manual input of the span. At the same time, the parameter coupling is set to *CENTER FIXED*.

The *START FIXED*, *CENTER FIXED* and *STOP FIXED* softkeys are mutually exclusive selection switches. Only one switch can be active at any one time. The frequency coupling is selected with these softkeys. The frequency coupling defines which of the dependent parameters start frequency, center frequency or stop frequency is to remain constant when the span is changed

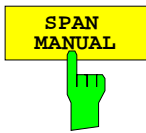

The *SPAN MANUAL* softkey activates the manual entry of the span.

The span entry range is for:
time domain (span = 0):

0 Hz

frequency domain (span > 0):

$$\text{minspan} \leq f_{\text{span}} \leq f_{\text{max}}$$

f_{span} frequency span
 minspan smallest selectable span (10Hz)
 f_{max} max. frequency

IEC/IEEE-bus command : [SENSe<1 | 2>:]FREQuency:SPAN 10MHZ

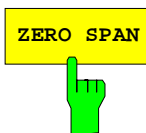

The *ZERO SPAN* softkey sets the span value to 0 Hz. The x axis becomes the time axis. The axis labelling corresponds to the sweep time (on the left, 0 ms, on the right, the current sweep time (SWT)).

IEC/IEEE-bus command : [SENSe<1 | 2>:]FREQuency:SPAN 0HZ

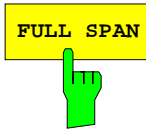

The *FULL SPAN* softkey sets the span value to the maximum span of the FSE.

IEC/IEEE-bus command : [SENSe<1|2>:]FREQuency:SPAN:FULL



The *LAST SPAN* softkey restores the previous setting if the span has been changed. This makes it possible to switch over between an overview measurement (*FULL SPAN*) and a detailed measurement (manually set center frequency and span).

The *FULL SPAN* softkey modifies the center frequency as well as the selected span. The *LAST SPAN* softkey cancels this change.

IEC/IEEE-bus command --

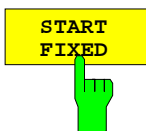

If the *START FIXED* softkey is activated, the start frequency remains constant when the span is changed. The center and stop frequency are adjusted to the new span.

IEC/IEEE-bus command : [SENSe<1|2>:]FREQ:SPAN:LINK START



If the *CENTER FIXED* softkey is activated, the center frequency remains constant when the span is changed. The center and stop frequency are adjusted to the new span. The *CENTER FIXED* coupling is the default setting.

IEC/IEEE-bus command : [SENSe<1|2>:]FREQ:SPAN:LINK CENTER



If the *STOP FIXED* softkey is activated, the stop frequency remains constant when the span is changed. The center and start frequency are adjusted to the new span.

IEC/IEEE-bus command : [SENSe<1|2>:]FREQ:SPAN:LINK STOP



The *FREQ AXIS LIN/LOG* softkey switches between linear and logarithmic scales on the frequency axis (see *START* key).

IEC/IEEE-bus command : [SENSe<1|2>:]SWEp:SPACing LIN | LOG

Display Zoom

FREQUENCY SPAN- ZOOM submenu:

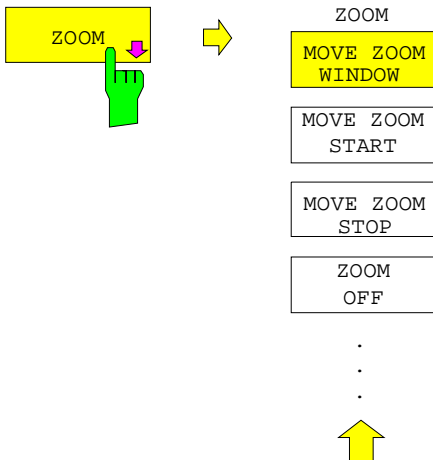

The **ZOOM** softkey activates the zoom mode and opens a sub-menu to define the zoom span.

Two frequency lines, which show and define the frequency range to be zoomed, appear in the active measurement window when the zoom mode is switched on. The default setting is a zoom span of 10% to the left and 10% to the right of the center frequency. The zoomed display is shown in the second measurement window.

The settings for the second measurement window are taken from the original window. The second measurement window thus becomes the active measurement window and its settings can now be changed.

If only one window is active when the zoom function is selected, **SPLIT SCREEN** mode is automatically switched on.

The zoom span can be edited by using the softkeys of the sub-menu to change the position of the frequency lines.

The softkey **ZOOM OFF** switches off the zoom.



The **MOVE ZOOM WINDOW** softkey shifts the whole zoom window. The window can be shifted until the upper frequency line reaches the stop frequency or the lower frequency line reaches the start frequency of the original window.

IEC/IEEE-bus commands

```
:DISPlay[:WINDow<1|2>]:TRACe<1..4>:X[:SCALe]:ZOOM ON
:DISPlay[:WINDow<1|2>]:TRACe<1..4>:X:ZOOM:CENTer 1GHz
```



The **MOVE ZOOM START** softkey shifts the lower frequency line. The start frequency of the zoomed display can then be modified. The frequency line can be shifted to the start frequency of the original window or to the upper frequency line (= zero span).

IEC/IEEE-bus commands

```
:DISPlay[:WINDow<1|2>]:TRACe<1..4>:X[:SCALe]:ZOOM ON
:DISPlay[:WINDow<1|2>]:TRACe<1..4>:X:ZOOM:START 100MHz
```



The **MOVE ZOOM STOP** softkey shifts the upper frequency line. Thus, the stop frequency of the zoomed display can be modified. The frequency line can be shifted to the stop frequency of the original window or to the lower frequency line (= zero span).

IEC/IEEE-bus commands

```
:DISPlay[:WINDow<1|2>]:TRACe<1..4>:X[:SCALe]:ZOOM ON
:DISPlay[:WINDow<1|2>]:TRACe<1..4>:X:ZOOM:STOP 200MHz
```

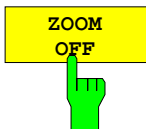

The **ZOOM OFF** softkey switches the zoom function off and then returns control to the main menu.

The frequency lines indicating the zoom range are deleted, **SPLIT SCREEN** mode remains active, the settings of both measurement windows are retained and the coupling of the two measurement windows is cancelled.

IEC/IEEE-bus command

```
:DISPlay[:WINDow<1|2>]:TRACe<1..4>:X[:SCALe]:ZOOM OFF
```

Level Display and RF Input Configuration – LEVEL Key Group

The *REF* and *RANGE* keys are used to set the reference level (= maximum RF input level, = overload limit), the maximum level (= upper grid level) , and the display range of the active window. The *INPUT* key sets the characteristics of the RF input (input impedance and input attenuation).

Reference Level – REF key

In addition to the reference level (maximum RF input level), the FSE provides a function to define a maximum level (uppermost grid line on the display):

For a spectrum analyzer, the upper boundary of the measurement diagram (maximum level) is also the limit of its dynamic range (reference level). This means, that a signal which goes beyond the upper grid line also overdrives the analyzer.

For compensation of frequency or antenna characteristics, transducer factors can be applied to increase the signal level. In this case, the calculated values can be above the reference level without actually being physically applied to the instrument. In order to display these signals on the grid, an upper grid level which is different from the reference level of the analyzer can be entered.

LEVEL REF menu:

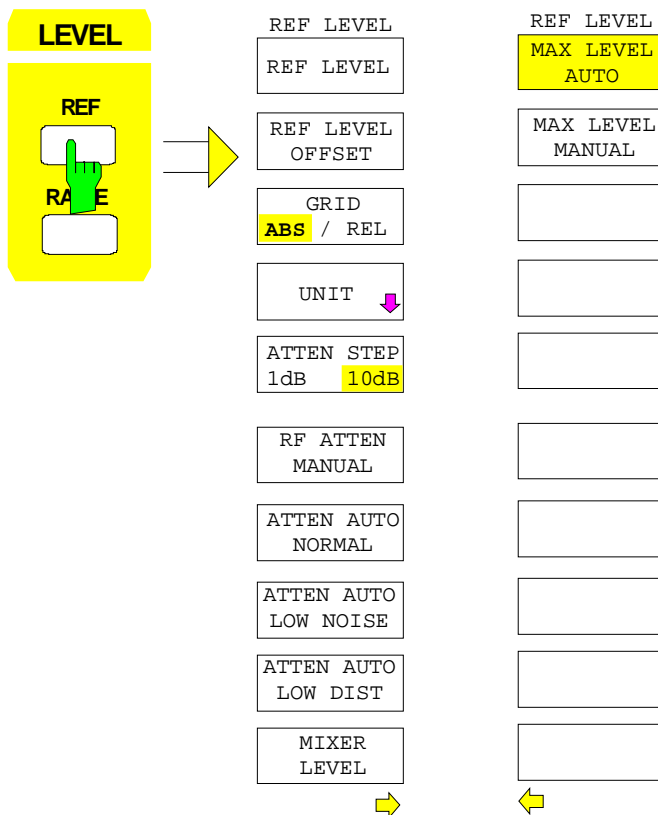

The *REF* key opens a menu to set the reference level and the input attenuation for the active measurement window .

The *REF LEVEL* softkey is automatically active with the menu called up and opens the entry window for manual input of the reference level.

At the same time various settings concerning the level and the attenuation display can be made.

The functions for setting the attenuation are identical to those under the *INPUT* key and are described in Section "Configuration of the RF Input - INPUT Key". Softkey *ATTEN STEP 1dB/10dB* is only available when the FSE is equipped with option FSE-B13, 1dB attenuator (see 'Option 1 dB Attenuator - FSE-B13' at the end of this Section.)



The *REF LEVEL* softkey activates the entry of the reference level. The unit of the entry will be the currently active unit (dBm, dB μ V, etc.).

If the *MAX LEVEL MANUAL* softkey is active, a change of the reference level causes an equal amount of change in maximum level. Thus, the separation between the overload limit of the analyzer to the upper grid edge remains the same. Thus, with only one entry, it is possible to make a change to the display and simultaneously to perform an adjustment to the amplifier.

IEC/IEEE-bus command

```
:DISPlay[:WINDow<1|2>]:TRACe<1..4>:Y:RLEVEL -60DBM
```



The *REF LEVEL OFFSET* softkey activates the entry of a straight level offset (± 200 dB in 0,1 dB steps). The offset is added to the measured level irrespective of the selected unit. The scaling of the y axis is changed accordingly. The input can be used to take into account an external attenuation.

The setting range is ± 200 dB in 0,1-dB steps.

IEC/IEEE-bus command

```
:DISPlay[:WINDow<1|2>]:TRACe<1..4>:Y:RLEVEL:OFFSet -1dB
```

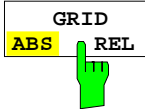

The *GRID ABS/REL* softkey toggles between absolute and relative scaling of the level axis. *GRID ABS* is the default setting.

For absolute scaling the labeling of the level lines is referenced to the absolute value of the reference level.

For relative scaling, the upper line of the grid is always at 0 dB and the scale units are in dB. In contrast, the reference level is always displayed in the set units (dBm, dB μ V,...).

The softkey is not displayed for setting *LIN / %* (linear scaling, labelling in %) in the *LEVEL-RANGE* menu since the % unit itself implies a relative scale.

IEC/IEEE-bus command

```
:DISPlay[:WINDow<1|2>]:TRACe<1..4>:Y:MODE ABS | REL
```

The *MAX LEVEL MANUAL* and *MAX LEVEL AUTO* softkeys are mutually exclusive selection switches. Only one switch can be active at one time. The softkeys are used to select whether reference level and maximum level are identical or not:



When *MAX LEVEL AUTO* softkey is active, the reference level and maximum level are identical.

In this case, the reference level is displayed above the upper left corner of the grid in the corresponding function field.

MAX LEVEL AUTO is the default setting.

If the *MAX LEVEL MANUAL* softkey was active prior to pressing the *MAX LEVEL AUTO* softkey, the upper boundary of the grid is set to the reference level.

IEC/IEEE-bus command

```
:DISPlay[:WINDow<1|2>]:TRACe<1..4>:Y:RVALue:AUTO ON
```

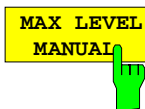

The *MAX LEVEL MANUAL* softkey activates the entry of the maximum level. The range of input values is ± 200 dBm with 0.1 dB resolution.

If the *MAX LEVEL MANUAL* softkey is activated, the maximum level is displayed in addition to the reference level to the right above the grid.

IEC/IEEE-bus commands

```
:DISPlay[:WINDow<1|2>]:TRACe<1..4>:Y:RVALue:AUTO OFF
```

```
:DISPlay[:WINDow<1|2>]:TRACe<1..4>:Y:RVALue -20DBM
```

Display Units

Generally, a spectrum analyzer measures the signal voltage at the RF input. The level display is calibrated in terms of terms values of an unmodulated sine wave. In the initial state, the level is displayed at a power of 1 milliwatt (= dBm). As the input impedance is known to be 50Ω or 75Ω, conversion to other units is possible. The units dBm, dBμV, dBμA, dBpW, V, A and W are directly convertible and can be selected in the *REF UNIT* menu.

Units dB./MHz have a special status. They are applicable for broadband pulse signals. The measured pulse voltage or the pulse current is referred to 1 MHz bandwidth. This conversion is not useful for narrowband or sinewave signals.

If the antenna coded connector on the front panel is used, the coded unit there determines the possible display units. Connecting to the coded connector deactivates the settings of the *UNIT* menu.

By certain codings it is nevertheless possible to select a conversion of the unit in the menu. The dependencies between the unit of the antenna coded connector or the unit of the transducer and the unit which is to be selected for the display are given in the softkey description.

The default coding defined by the connector can be switched off using the *PROBE CODE ON/OFF* softkey. In this case, the unit can be set with the corresponding unit softkeys (dBm, dBμV, ...) even if a coded connector is plugged in. The coded entries in the connector are then ignored.

Note: The units dBμV/m and dBμA/m can only be set via the unit of a transducer or via the unit of the coded connector.

LEVEL REF UNIT submenu:

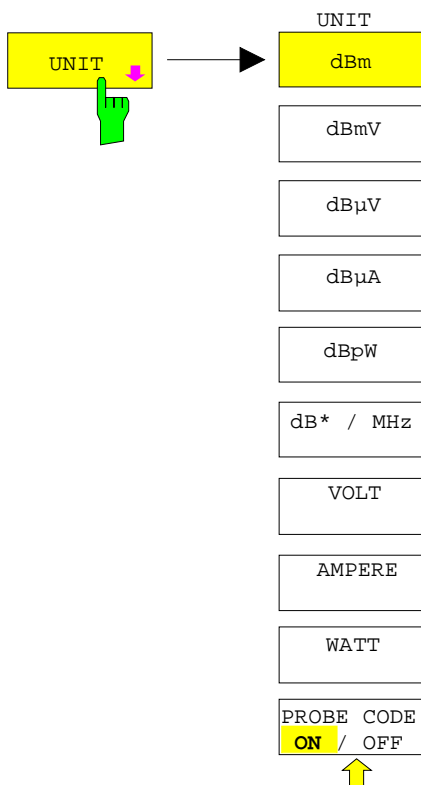

The *UNIT* softkey opens a sub-menu in which the desired units for the level axis can be selected and the coding of the antenna coded connector can be switched on and off.

The selected units are valid for both displays when two measurement windows are displayed.

The unit softkeys are mutually exclusive selection switches. Only one of these switches may be active at any one time.

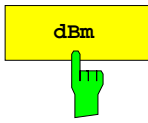

The *dBm*, *dBμV*, *dBmV*, *dBμA*, *dBpW* softkeys set the display units to the corresponding logarithmic units. The *dBm* unit is the default unit in analyzer mode.

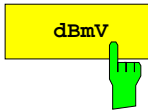

The units *dBm*, *dBμV*, *dBmV*, *dBμA* cannot be selected when the coded antenna connector or the used transducer defines a unit.

Only for coding dB, the conversion to the desired units is permitted.

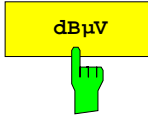

IEC/IEEE-bus command
`:CALCulate<1|2>:UNIT:POWER DBM |DBMV |DBUV |DBUA |DBPW`

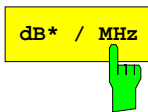
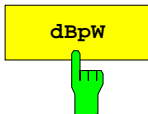
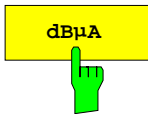

The *dB*/MHz* softkey activates/disactivates the display of results in units relative to the bandwidth. Those units can be derived from the logarithmic units *dBμV*, *dBμV/m*, *dBμA* and *dBμA/m*.

This leads to the following relative units:

- dBmV* ⇒ *dBmV/MHz*
- dBμV* ⇒ *dBμV/MHz*
- dBμV/m* ⇒ *dBμV/mMHz*
- dBμA* ⇒ *dBμA/MHz*
- dBμA/m* ⇒ *dBμA/mMHz*

Switching over is possible also if a coded antenna connector or a transducer fixes the unit to be used.

Conversion to 1 MHz is via the pulse bandwidth of the selected resolution bandwidth B_{imp} according to the following equation (example for *dBμV*) :

$$P / (dB\mu V / MHz) = 20 \cdot \log \frac{B_{imp} / MHz}{1MHz} + P / (dB\mu V),$$

where P = display level

The *dBμV/MHz* unit can be combined with the following coded connector or transducer units

dB (the unit *dBμV/MHz* remains)

$\mu V/m$ (yields the display unit *dBμV/mMHz*)

analogous for *dBμA/MHz*:

dB and μA (the unit *dBμA/MHz* remains)

Other combinations are not allowed.

IEC/IEEE-bus command
`:CALCulate<1|2>:UNIT:POWER DBUV_MHZ |DBUA_MHZ |DBMV_MHZ`

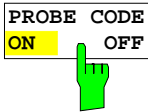
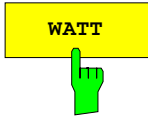
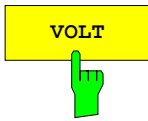

The *VOLT*, *AMPERE*, *WATT* softkeys set the display units to the corresponding linear units.

The units *VOLT*, *AMPERE*, *WATT* cannot be selected when the coded antenna connector or the transducer table defines one of the following as units:

$\mu\text{V/m}$
 μA

For coding dB, the conversion to the desired units is permitted.

The *PROBE CODE ON/OFF* softkey enables or disables the units defined by the coded connector.

IEC/IEEE-bus command :UNIT<1 | 2>:PROBe ON | OFF

Level Range – RANGE Key

LEVEL RANGE menu:

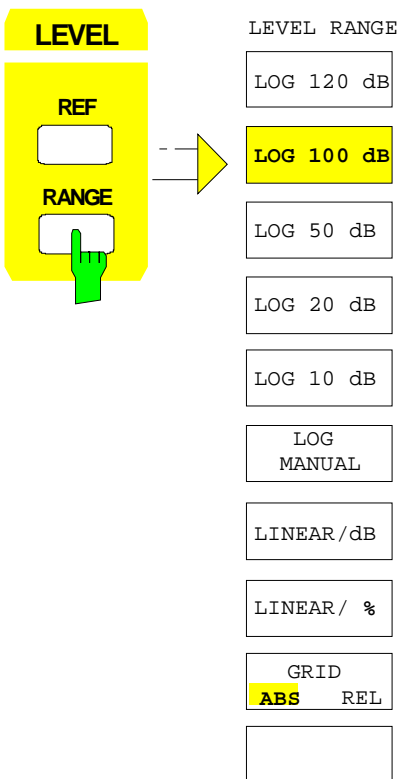

The *RANGE* key calls a menu in which the range, linear or logarithmic the display scale, absolute or relative and the level units for the active window can be selected.

The display range of the analyzer can be set in 10 dB steps from 10 to 200 dB. The default setting is 100 dB.

The most often used settings (120 dB, 100 dB, 50 dB, 20 dB and 10 dB) are each directly selectable by a softkey. All other ranges are chosen with the *LOG MANUAL* softkey.

After pressing the *RANGE* key, the *LOG MANUAL* entry window is enabled if the display range is not set to *LIN*.



The *LOG MANUAL* softkey activates the entry of the level display range. Display ranges from 10 to 200 dB are allowed in 10-dB steps. Values which are not permissible are rounded to the next valid number.

IEC/IEEE-bus commands

```
:DISPlay[:WINDow<1|2>]:TRACe<1..4>:Y:SPACing LOG
:DISPlay[:WINDow<1|2>]:TRACe<1..4>:Y 110DB
```

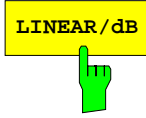

The *LINEAR/dB* softkey switches the display range of the analyzer to linear scaling. The horizontal lines are labelled according to the selection *GRID ABS/REL* in dB* or *.

IEC/IEEE-bus command

```
:DISPlay[:WINDow<1|2>]:TRACe<1..4>:Y:SPACing LINear
```

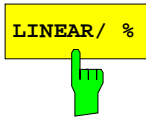

The *LINEAR/%* softkey switches the display range of the analyzer to linear scaling. The horizontal lines are labelled in %. The grid is divided into decades.

IEC/IEEE-bus command

```
:DISPlay[:WINDow<1|2>]:TRACe<1..4>:Y:SPACing PERCent
```

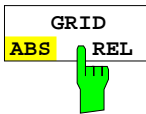

The *GRID ABS/REL* softkey switches between absolute and relative scaling of the level axis. *GRID ABS* is the default setting.

ABS The labelling of the level lines is referenced to the absolute value of the reference level.

REL The upper line of the grid is always at 0 dB and the scale units are in dB. In contrast, the reference level is always displayed in the set units (dBm, dBμV,...).

The softkey is not displayed for setting *LIN / %* (linear scaling, labelling in %) since the % unit itself implies a relative scale.

IEC/IEEE-bus command

```
:DISPlay[:WINDow<1|2>]:TRACe<1..4>:Y:MODE ABS | REL
```

RF Input Configuration – INPUT Key

In addition to manual entry of the input attenuation, the FSE provides an option which allows the RF attenuation, dependent on the selected reference level, to be automatically set. Thus, it is guaranteed that an optimum combination of RF attenuation and IF amplification is always used. For the automatic selection process, three modes are provided. The *AUTO LOW NOISE* mode selects the amplification/attenuation combination so that the display of noise on the FSE is at a minimum. The signal/noise ratio is maximised. The *AUTO LOW DISTORTION* mode is tuned for minimisation of the internally generated interference products. This causes, however, a lower signal/noise ratio. The *ATTEN AUTO NORMAL* mode is a compromise between low noise and low distortion.

When the FSE is equipped with option FSE-B13, 1 dB Attenuator, the attenuator can be set with a step size of 1 dB up to an upper limit frequency of 7 GHz.

When the instrument is equipped with option FSE-B21, External Mixer Output, the FSEM and FSEK can be operated with external mixer.

INPUT menu:

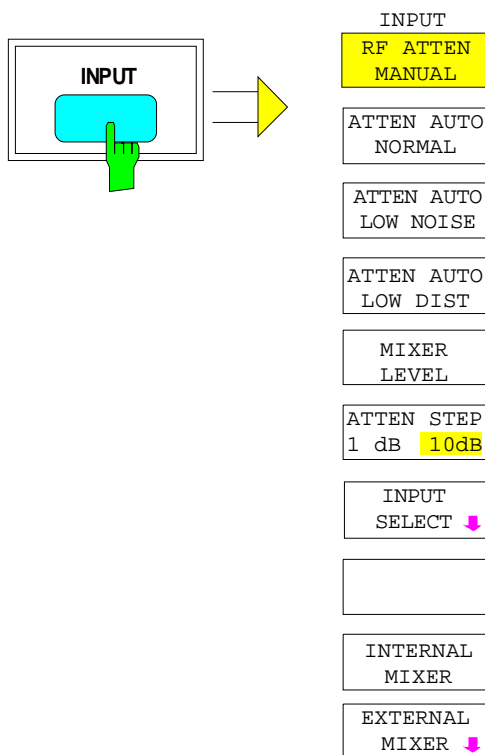

The *INPUT* key opens the menu for configuring the RF input. It contains the input attenuator and mixer level for matching the RF input to the input signal.

The *RF ATTEN MANUAL*, *ATTEN AUTO NORMAL*, *ATTEN AUTO LOW NOISE* and *ATTEN AUTO LOW DIST* softkeys are mutually exclusive selection switches. only one can be active at any one time.

Softkey *ATTEN STEP 1dB/10dB* is only available when the FSE is equipped with option FSE-B13, 1dB attenuator (see 'Option 1 dB Attenuator - FSE-B13' at the end of this Section.)

Softkeys *INTERNAL MIXER* and *EXTERNAL MIXER* are only available when the FSE is equipped with option FSE-B21, External Mixer Input (see manual of option).

The *INPUT SELECT* softkey calls a submenu for selection of the input impedance.

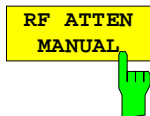

The *RF ATTEN MANUAL* softkey activates the entry of an attenuation factor independent of the reference level.

The attenuation can be modified in 10 dB steps between 0 and 70 dB.

Other inputs will be rounded to the next higher integer value.

If the defined reference level cannot be set for the given RF attenuation, the reference level will be adjusted accordingly and the warning "Limit reached" will be output.

IEC/IEEE-bus command :INPut<1|2>:ATTenuation 40DB



The *ATTEN AUTO NORMAL* softkey sets the RF attenuation automatically as a function of the selected reference level.

IEC/IEEE-bus commands

```
:INPut<1 | 2>:ATTenuation:AUTO:MODE NORMal
:INPut<1 | 2>:ATTenuation:AUTO ON
```



The *ATTEN AUTO LOW NOISE* softkey sets the RF attenuation always 10dB lower than in the *RF ATTEN AUTO* mode. Therefore, for 10 dB RF attenuation, the maximum reference level is -10 dBm. For reference levels which are lower, at least 10 dB is always set (see above).

Setting Low Noise means that the indicated inherent noise level is low. This setting is recommended if signals with a low level have to be measured as the highest S/N ratio is then obtained.

IEC/IEEE-bus commands

```
:INPut<1 | 2>:ATTenuation:AUTO:MODE LNOise
:INPut<1 | 2>:ATTenuation:AUTO ON
```



The *ATTEN AUTO LOW DIST* softkey sets the RF attenuation 10 dB higher than in *RF ATT AUTO* mode. This means that for 10 dB RF attenuation, the maximum reference level is -30 dBm (-40 dBm at the mixer).

This setting is recommended whenever a small signal is to be measured in the presence of larger signals. Here, the intermodulation-free range of the FSE is large and the internal distortion products are minimised.

IEC/IEEE-bus commands

```
:INPut<1 | 2>:ATTenuation:AUTO:MODE LDISTortion
:INPut<1 | 2>:ATTenuation:AUTO ON
```



The *MIXER LEVEL* softkey activates the entry of the maximum mixer level attainable for a given reference level. At the same time it enables softkeys *ATTEN AUTO LOW NOISE* and *ATTEN AUTO LOW DIST*.

Range of input values is -10 to -100 dBm

IEC/IEEE-bus command :INPut<1 | 2>:MIXer -30DBM

INPUT INPUT SELECT submenu:

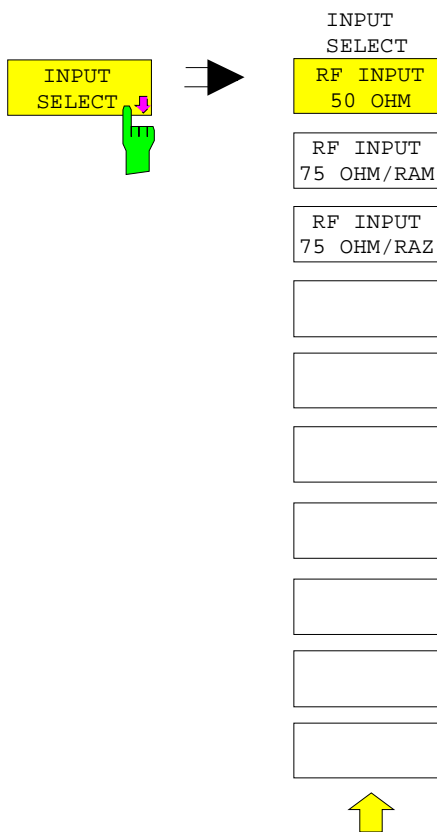

The *INPUT SELECT* softkey calls a submenu for selection of the input impedance of the RF input.

The basic setting is 50 Ohm. By connecting an impedance converter RAM or RAZ ahead, the 50-Ohm input can be transformed to 75 Ohm. FSE automatically takes the corresponding correction values for the level display into account.

The softkeys used to select the input impedance are selection switches. Only one of them can be active at any one time

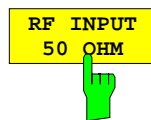

The *RF INPUT 50 OHM* softkey sets the input impedance to 50 Ohm (= default setting). All level indications are referenced to 50 Ohm.

IEC/IEEE-bus command :INPut<1|2>:IMPedance 50

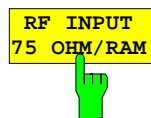

The *RF INPUT 75 OHM/RAM* softkey sets the input impedance of the FSE to 75 Ohm including the matching element RAM. All level indications are referenced to 75 Ohm.

IEC/IEEE-bus command :INPut<1|2>:IMPedance:CORR RAM

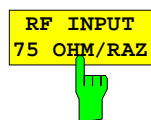

The *RF INPUT 75 OHM/RAZ* softkey sets the input impedance of the FSE to 75 Ohm including the matching element RAZ. All level indications are referenced to 75 Ohm.

IEC/IEEE-bus command :INPut<1|2>:IMPedance:CORR RAZ

Option 1 dB Attenuator - FSE-B13

The option 1 dB Attenuator FSE-B13 is used to set the attenuator with a step size of 1 dB up to an upper limit frequency of 7 GHz.

The attenuator with 1 dB stepping is connected in series after the main attenuator.

Instruments with an Upper Limit Frequency of up to 7 GHz

The optional attenuator is in the signal path for all settable frequencies in instruments with a maximum upper limit frequency of 7 GHz. When it is activated, it is used without any restriction for setting the input attenuation or the reference level.



Instruments with an Upper Limit Frequency of more than 7 GHz

In instruments with an upper limit frequency of more than 7 GHz a diplexer is placed before the optional attenuator for separating the frequency ranges $\leq 7\text{GHz}$ and $> 7\text{GHz}$. The optional attenuator is in the signal path only for frequencies $\leq 7\text{GHz}$.

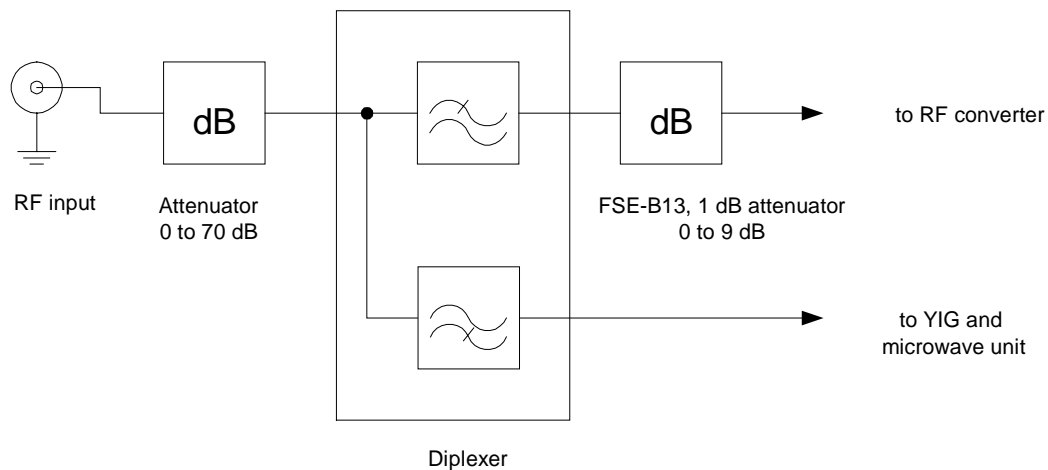

On changing the frequency range for the stop frequency, the attenuator can be set as follows:

Instrument setting: ATTENUATOR AUTO

- After switching from $F_{\text{stop}} \leq 7$ GHz to $F_{\text{stop}} > 7$ GHz the reference level is re-calculated provided the attenuation previously set contained 1 dB steps. A warning is not displayed.
- After switching from $F_{\text{stop}} > 7$ GHz to $F_{\text{stop}} \leq 7$ GHz the reference level is re-calculated. A warning is not displayed.

Instrument setting: ATTENUATOR MANUAL

- After switching from $F_{\text{stop}} \leq 7$ GHz to $F_{\text{stop}} > 7$ GHz, the attenuation is rounded off to a value divisible by 10 provided the attenuation previously set contained 1 dB steps. A warning is displayed:

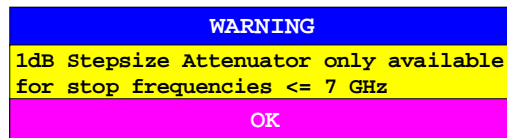

- After switching from $F_{\text{stop}} > 7$ GHz to $F_{\text{stop}} \leq 7$ GHz the current value of the input attenuation is maintained.

The 1 dB attenuator is inactive as default. In this case the attenuation can be set only in 10 dB steps, ie the attenuation of the optional attenuator is fixed at 0 dB.

The optional attenuator is activated either in the INPUT menu or in the REF LEVEL menu (the two settings are equivalent):



The *ATTEN STEP* 1dB/10dB softkey switches between the 10 dB step and 1 dB step settings.

After activating the optional attenuator with the *ATTEN STEP 10dB/1dB* softkey, setting in 1 dB steps is possible, the total attenuation is divided into

- a 10 dB contribution from the main attenuator and
- a residual contribution of 0 to 9 dB from the optional attenuator.

The attenuation setting range in the instrument remains to be 0 to 70 dB, it is **not** extended by the optional attenuator.

After a reset the attenuator step size is automatically set to 10 dB.

IEC/IEEE-bus command :INPut<1|2>:ATTenuation:STEPsize 1|10

Marker Functions – *MARKER* Key Group

The markers are used for marking points on measurement curves (traces), reading out measurement values and for quickly selecting a screen mode. Preselected measurement routines can be called by pressing a key in the marker menu. The FSE has four markers and four delta markers per measurement window. The currently activated marker can be shifted with the cursor keys, the roll-key or the softkeys. The softkeys are defined according to the type of display representation selected (frequency or time domain).

The marker which can be moved by the user is defined as the **active marker**.

Examples of marker displays:

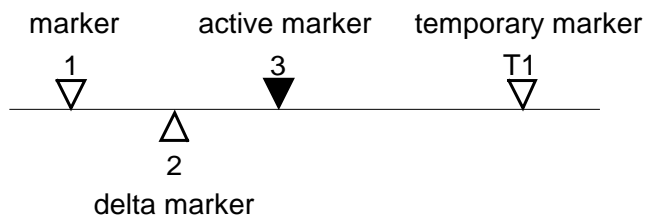

Temporary markers are used in addition to the markers and delta markers to evaluate the measurement results. They disappear when the associated function is deactivated.

The measurement values of the active marker (also called **marker values**) are displayed in the marker field. In the **marker info list**, the measurement values from all enabled markers are sorted in ascending order. The marker info list can be switched off with the *MARKER INFO* softkey so that only the values for the active marker are shown.

The summary markers have a special function. They read out the rms or average value of the current trace or the trace averaged over several sweeps in the marker info list. These markers are not displayed.

Main Markers– *NORMAL* Key

The *NORMAL* key calls a menu which contains all the standard marker functions. The current state of the markers is indicated by a colored illumination of the softkeys. If no marker is enabled prior to pressing the *NORMAL* key, *MARKER 1* will be enabled as the reference marker and a peak search on the trace is carried out (assumption: at least one trace is active). Otherwise, the peak search is omitted and the entry window for the reference marker is activated.

The marker field in the upper right corner of the display screen shows the marker values, in this case, the frequency, the level and the currently selected trace.

```
MARKER 1 [T1]
-27.5 dBm
123.4567 MHz
```

MARKER NORMAL menu:

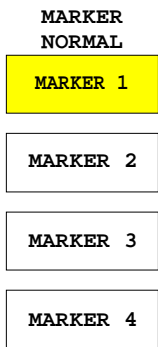
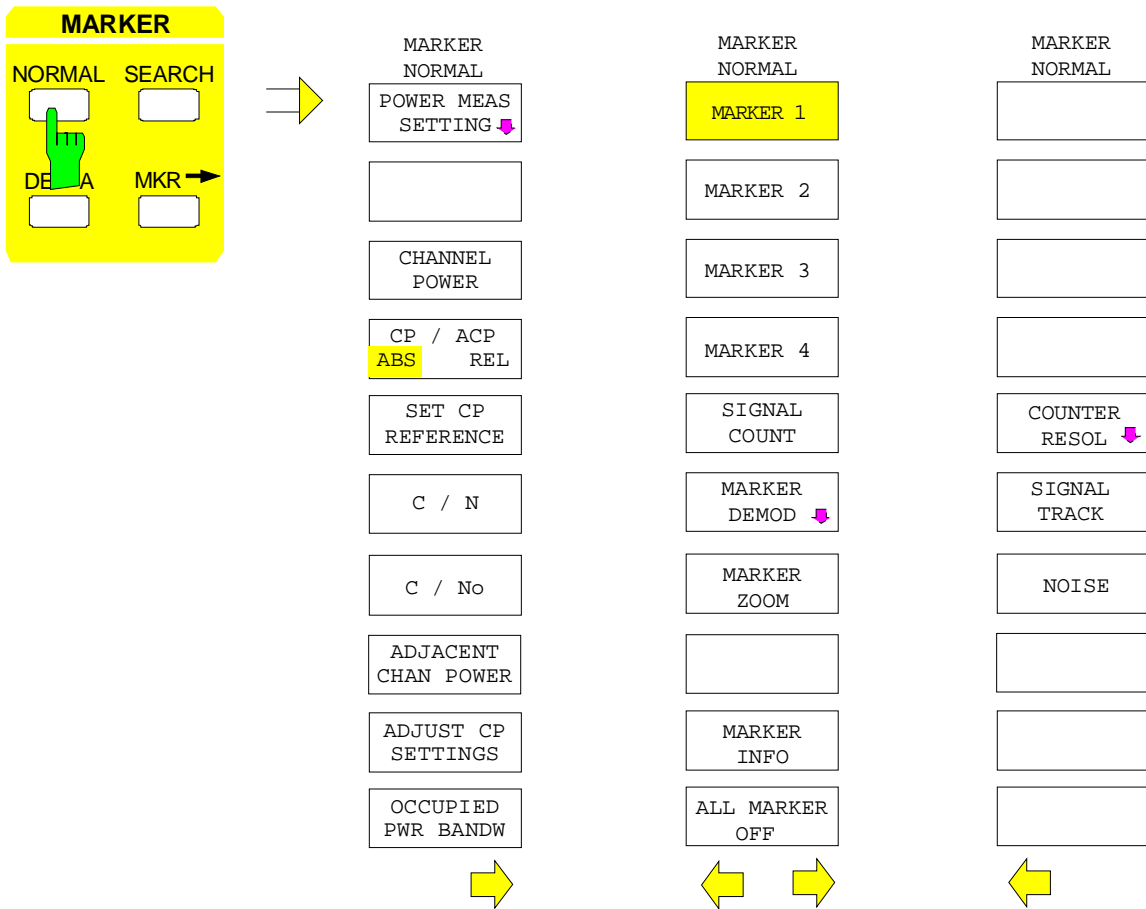

The *MARKER 1* to *MARKER 4* softkeys switch the corresponding marker on/off or activate it as the reference marker. If the marker is activated as a reference marker, an entry field for manually setting the position of the reference marker is opened simultaneously. If the marker is disabled, the softkey is not illuminated. Enabled markers and the reference marker are indicated by illuminating the corresponding softkeys in different colors. (In the instrument default state, the active reference marker is displayed in red and enabled markers are displayed in green.)

Operating example:

MARKER 1 is shown as the reference marker by the colored background illumination. *MARKER 2* through *MARKER 4* are turned off.

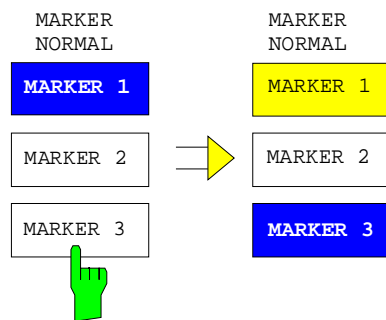

Pressing the *MARKER 3* softkey switches *MARKER 3* on and it becomes the reference maker. The previous reference marker remains enabled and the softkey remains illuminated. However, the entry mode for this marker is not now active. Instead, the entry window for *MARKER 3* is opened and the position of *MARKER 3* can be shifted.

| |
|--------------|
| MARKER 3 |
| 123.4567 MHz |
| |

The information in the marker field also changes to describe the new reference marker.

| |
|----------------|
| MARKER 3 [T1] |
| -27.5 dBm |
| 23.4567891 MHz |

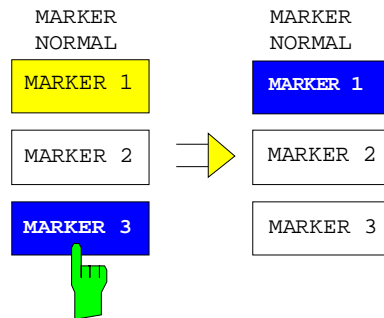

Pressing the current reference marker (*MARKER 3*) softkey again switches *MARKER 3* off. If at least one marker is enabled, the marker with the smallest number will be selected as the new reference marker (in the example, *MARKER 1*). Switching off the last active marker also deletes any delta markers.

IEC/IEEE-bus commands

```
:CALCulate<1|2>:MARKer<1..4>[:STATE] ON | OFF;
:CALCulate<1|2>:MARKer<1..4>:X 10.7MHz;
:CALCulate<1|2>:MARKer<1..4>:Y?
```

When several traces are displayed, the marker is set to the maximum value (peak) of the active trace with the lowest number (1 to 4). If a marker is already positioned there, it will be set to the frequency of the next highest level (next peak).

When the split screen mode is active, the marker will be placed in the active window (for *SCREEN A*: trace 1 or 3, for *SCREEN B*: trace 2 or 4). Since markers are attached to a trace, the marker can only be enabled when at least one trace is displayed in the corresponding window.

If a trace is turned off, the markers and marker functions attached to the trace are also switched off. If the trace is switched on again (*VIEW, CLR/WRITE;..*), these markers, along with any coupled functions will be restored to their original positions. A prerequisite for the restoration of the marker positions is that individual markers have not been used on another trace or that the sweep data (start/stop frequency for span > 0 or sweep time for span = 0) have not been changed.

If a marker (or, delta marker) necessary for a marker function is not available, it will be automatically checked whether or not the enabling of the corresponding marker is possible (see above). If this is not the case, a warning is issued.

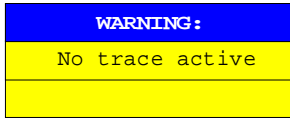

The activation of the desired marker function is then not possible.

On the other hand, if the marker can be enabled, a peak search is automatically performed. Thereafter, the desired marker function can be executed.

MARKER NORMAL menu:



The *ALL MARKER OFF* softkey switches off all markers (reference and delta markers). Similarly, it switches off all functions and displays correlated with the markers/delta markers (signal count, signal track, marker zoom, N dB down, shape factor, marker list and marker info).

IEC/IEEE-bus command :CALCulate<1|2>:MARKer<1..4>:AOFF

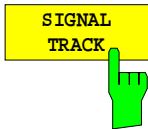

After each sweep, the *SIGNAL TRACK* softkey starts a search for the maximum signal level on the screen (*PEAK SEARCH*) and then sets the center frequency to the frequency of this signal (*MARKER ->CENTER*).

If a threshold line is enabled, only signals above the threshold level are considered. If no signal is over the threshold, the center frequency remains constant until a signal is available which is over the threshold.

If no marker is switched to the active trace, the next unused marker is automatically activated and positioned by the peak search routine.

In order to reduce the search range, it is possible to apply the *SEARCH LIMIT ON/OFF* function (see section: "Search Functions"). If the center frequency is changed, the position of the frequency line relative to the center frequency remains the same, ie its absolute position is correspondingly changed.

The softkey is only available in the frequency domain (spectrum) display mode (span > 0.)

IEC/IEEE-bus commands

```
:CALCulate<1|2>:MARKer<1..4>:COUNT ON |OFF;
:CALCulate<1|2>:MARKer<1..4>:COUNT:FREQuency?
```

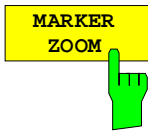

The *MARKER ZOOM* softkey expands the area around the active marker. With the zoom function, more details of the spectrum can be seen. The desired display range can be defined in an entry window.

The sweep is stopped at the reference marker. The frequency of the signal is counted and the measured frequency becomes the new center frequency. The zoomed display is set and the new settings are used by the FSE for further measurements.

As long as the switchover to the new frequency display range has not yet taken place, pressing the softkey will abort the procedure.

If no marker is activated when the softkey is pressed, then *MARKER 1* is automatically activated and set to the highest peak in the measurement window.

If an instrument setting is changed after selection of *MARKER ZOOM*, the function is aborted.

The *MARKER ZOOM* softkey is only available for frequency domain measurements (span > 0).

IEC/IEEE-bus command

```
:CALCulate<1|2>:MARKer<1..4>:FUNCTION:ZOOM 1KHZ
```



The *MARKER INFO* softkey opens the display of several markers within the grid. In the upper right corner of the grid, a maximum of 4 markers/delta markers with the marker symbols Δ/∇ , marker number (1 to 4), position and measurement value are listed. For the output of the marker position, the number or displayed characters will be limited as required.

If the number of lines available is not enough for all the enabled markers and delta markers, first the markers and then the delta markers are entered into the info list

In the *SPLIT SCREEN* display, the info list is partitioned into 2 partial lists and assigned to the corresponding measurement window (*SCREEN A* and *SCREEN B*). The info list for *SCREEN A* contains the markers which are assigned to trace 1 or trace 3. The info list for *SCREEN B* contains the markers which are assigned to trace 2 and trace 4.

For the two measurement windows, it is not possible to turn the *MARKER INFO* function selectively on/off .

IEC/IEEE-bus command :DISPlay:WINDow<1|2>:MINfo ON | OFF

LF Demodulation

The FSE provides demodulators for AM and FM signals. With these demodulators, a displayed signal can be identified acoustically with of the internal loudspeaker or with external headphones. The frequency at which demodulation is activated is coupled to the markers. The sweep stops at the frequency determined by the set marker for the selected time and the RF signal is demodulated.

During time domain measurements (span = 0) the demodulation is switched on continuously.

MARKER NORMAL-MARKER DEMOD submenu:

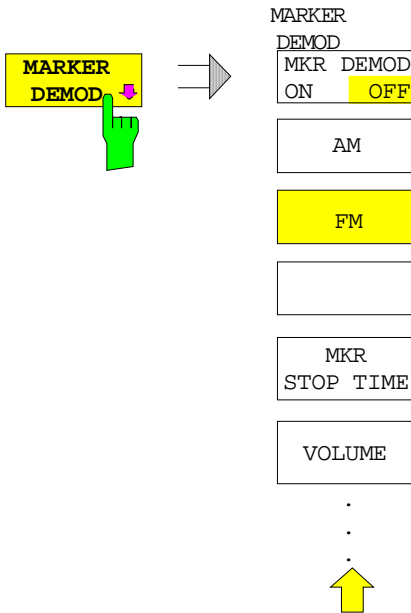

The *MARKER DEMOD* softkey calls a sub-menu in which the type of demodulation desired, the duration of the demodulation and the loudness may be selected

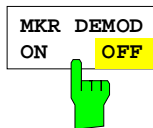

The *MKR DEMOD ON/OFF* softkey switches the demodulation on/off. When the demodulation is on, the sweep is stopped at all marker frequencies, assuming the signal is over the threshold, and the signal is demodulated until the entered sweep stop time elapses. A total of four stopping points (four markers) can be programmed.

If no marker is set when the demodulation is switched on, the FSE switches the first marker on (*MARKER 1*) and positions it on the trace peak.

IEC-Bus-Befehl

```
:CALCulate<1|2>:MARKer<1..4>:FUNCTION:DEM ON|OFF
```



The *MKR STOP TIME* softkey activates the entry window for setting the stop time.

The FSE stops the sweep at the marker or the marker for the duration of the defined stop time and then switches the demodulation on (see also *MKR DEMOD ON/OFF*).

IEC-Bus-Befehl

```
:CALCulate<1|2>:MARKer<1..4>:FUNCTION:DEM:HOLDoff 3s
```

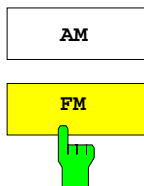

The *AM* and *FM* are selection switches of which only one can be activated at any one time. They are used to set the desired demodulation type, FM or AM. The default setting is AM.

IEC-Bus-Befehl

```
:CALCulate<1|2>:MARKer<1..4>:FUNCTION:DEM:SElect AM|FM
```



The *VOLUME* softkey opens the entry window for setting the loudness. The volume can be set between 0 and 100%.

IEC-Bus-Befehl :SYSTEM:SPEaker<1|2>:VOLume 0.5

Frequency Measurement

To accurately determine the frequency of a signal, the FSE is equipped with an internal frequency counter. The frequency counter measures the frequency of the RF signal at the intermediate frequency. Using the value found at the intermediate frequency, the FSE calculates the frequency of the RF signal by applying the known frequency conversion relationships.

The frequency measurement error depends only upon the accuracy of the frequency standard used (external or internal reference). Although the FSE always performs the frequency sweep in sync - no matter what frequency range is set - the frequency counter gives a more exact frequency measurement than a measurement performed with a marker. This is explained by the following:

- The marker only gives the position of a pixel on the trace and the frequency of the signal is deduced from this. The trace, however, contains only a limited number of pixels, so each pixel may represent a number of measurement values that depends on the selected span. This reduces the frequency resolution.
- The resolution with which the frequency can be measured is proportional to the measurement time. For measurement time reasons, the bandwidth is normally held as wide as possible and the sweep time is set as short as possible. This results in a loss of frequency resolution.

For the measurement with the frequency counter, the sweep is stopped at the reference marker, the frequency is measured to the desired resolution and then the sweep is allowed to continue (see also Chapter 2, "Measurement Examples").

MARKER NORMAL menu:

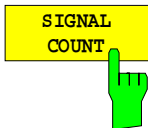

The *SIGNAL COUNT* softkey switches the frequency counter on/off.

The frequency is counted at the position of the reference marker. The sweep stops at the reference marker until the frequency counter outputs a result. The time required for a frequency measurement depends on the selected frequency resolution. The resolution is set in the *COUNTER RESOL* sub-menu.

If no marker is enabled when the *SIGNAL COUNT* softkey is pressed, *MARKER 1* is switched on and set to the trace peak.

The *SIGNAL COUNT* function is also indicated by [T x CNT] in the marker field on the display screen.

Switching the *SIGNAL COUNT* function off is accomplished by pressing the softkey once again.

Note: For digital resolution filters (RBW < 1kHz or softkey RBW 1kHz set to DIG), a analog prefilter of 2 kHz is active.

IEC/IEEE-bus command

```
:CALCulate<1|2>:MARKer<1..4>:COUNT ON | OFF;
:CALCulate<1|2>:MARKer<1..4>:COUNT:FREQUENCY?
```

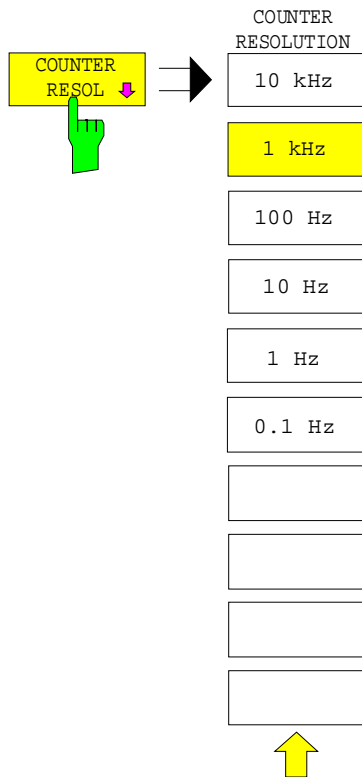

The *COUNTER RESOL* softkey in the right side menu opens a sub-menu in which the resolution of the frequency counter can be defined.

The value can be selected between 0.1 Hz and 10 kHz.

The time which the frequency counter requires for a measurement is proportional to the selected resolution. For example, a 1 Hz resolution will require approximately one second measurement time. In order to prevent slowing the sweep time unnecessarily, it is recommended that the frequency resolution be set as low as possible.

IEC/IEEE-bus command

```
:CALCulate<1|2>:MARKer<1..4>:COUNT:RES 1KHZ
```

Noise Power Density Measurement

MARKER NORMAL menu (right side menu):

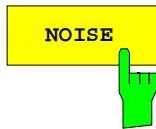

The *NOISE* softkey switches noise measurement on/off.

During a noise measurement, the noise power density is measured at the position of the reference marker. The noise power density is displayed in the marker field dependent upon the vertical units in dBx/Hz (for logarithmic scale) or in V/Hz, A/Hz or W/Hz for linear scales. The correction factors for the selected bandwidth and the conversion of the IF logarithmic converter are automatically taken into consideration.

For trace setting AUTO SELECT, the sample detector is automatically switched on and off with the noise marker to provide for display of the rms value of the noise power. For single sweep, a new sweep has to be started after the marker has been switched on in order to ensure that the trace is recorded with the correct detector.

For all other detector settings, the user is prompted to select the sample detector for optimum results as soon as the noise marker is switched on. In this case the sample detector has to be switched on manually.

In order to produce a smoother noise display, neighboring points (symmetrical to measurement frequency) on the trace are averaged.

In the time domain display, an average of the measurement values takes place in time (after each sweep).

IEC/IEEE-bus command

```
:CALCulate<1|2>:MARKer<1..4>:FUNCTION:NOISe ON | OFF;  
:CALCulate<1|2>:MARKer<1..4>:FUNCTION:NOISe:RESult?
```

Channel Power Measurements

A modulated carrier is almost always used (exception e.g.,: SSB-AM) for high-frequency transmission of information. Due to the information modulated onto the carrier, the latter covers a spectrum which is defined by the modulation, the data transmission rate and the signal filtering. Within a transmission band, each carrier is assigned a channel taking into account these parameters. In order to ensure error-free transmission, each transmitter must keep within its specified parameters. These include among others:

- the output power,
- the occupied bandwidth, i.e., the bandwidth within which a defined percentage of the power must be contained and
- the power received by adjacent channels.

Using the power measurement function, the FSE is capable of measuring all the specified parameters with high precision and at high speed.

The power measurements settings are performed in the left-hand side-menu *MARKER NORMAL*.

MARKER NORMAL menu:

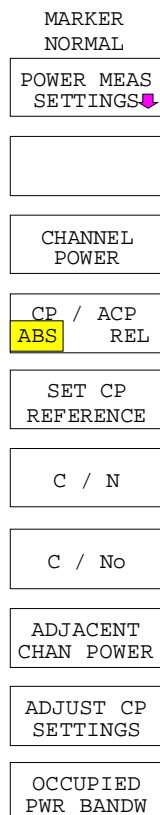

The following measurements can be made:

- channel power (*CHANNEL POWER*)
- signal / noise power (*C/N*)
- signal / noise power density (*C/No*)
- adjacent channel power (*ADJACENT CHAN POWER*)
- occupied bandwidth (*OCCUPIED PWR BANDWIDTH*)

The channel power and the adjacent channel power can be measured either relative (*CP/ACP REL*) to the power in the utilised channel or in absolute terms (*CP/ACP ABS*).

Channel configuration is via sub menu *POWER MEAS SETTINGS*.

The above mentioned power measurements can be performed alternately.

Channel Configuration

For all power measurements, a specified channel configuration is assumed which is, e.g. oriented on a specific radio communications system.

The channel configuration is defined by the nominal channel frequency (= center frequency of the FSE), the channel bandwidth (*CHANNEL BANDWIDTH*) and the channel spacing (*CHANNEL SPACING*).

The channel is indicated on the display screen by vertical lines located at a half-channel bandwidth to the left and to the right of the channel frequency. For the adjacent channel power measurement, the adjacent channels are also indicated by vertical lines. The lines of the utilised channel are labelled with CO for easier recognition.

Depending on the radio communication service, the power of the 1st alternate channel and/or 2nd alternate channel can be measured in addition (softkey *SET NO.OF ADJ CHAN'S*).

With the *ACP STANDARD* softkey, the channel configuration can be set automatically according to the regulations of different digital mobile-radio standards. For some standards, the channel power has to be evaluated by means of a root-cosine filter corresponding to the transmit filter. This filter is switched on automatically if the corresponding standards are selected but can be switched off manually (softkey *CH FILTER ON/OFF*).

MARKER NORMAL - POWER MEAS SETTINGS submenu:

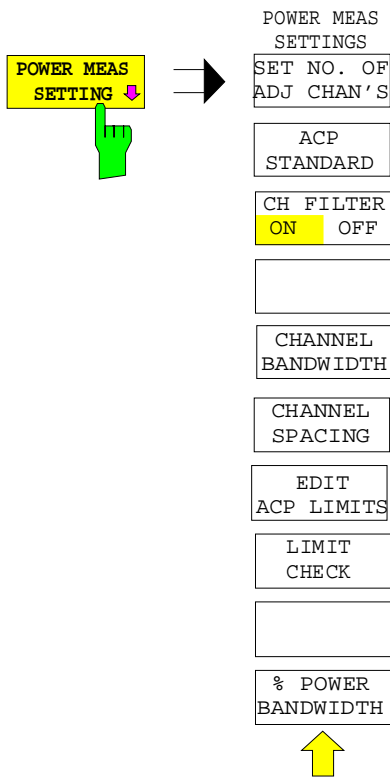

The *POWER MEAS SETTINGS* softkey calls the sub-menu for the definition of the channel configuration.

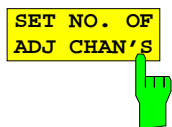

The *SET NO. OF ADJ CHAN'S* softkey activates the input of number $\pm n$ adjacent channels to be considered for adjacent channel power measurement

The individual powers are indicated separately. Example $n=3$:

```

CH0 Pwr  -20.00 dBm
ACP UP   -45.23 dBm
ACP LOW  -52.11 dBm
ALT1 UP  -60.04 dBm
ALT1 LOW -61.00 dBm
ALT2 UP  -63.34 dBm
ALT2 LOW -64.00 dBm
    
```

1, 2 or 3 adjacent channels are possible. ALT1 and ALT2 (Alternate Channel Power) indicate the channel power at $\pm 2 \times$ channel spacing and $\pm 3 \times$ channel spacing from the center of the channel.

IEC/IEEE-bus command : [SENSe<1|2>:]Power:ACHannel:ACPairs 2

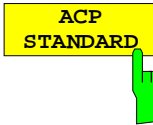

The *ACP STANDARD* softkey activates the selection of a digital mobile-radio standard. The parameters for the adjacent channel power measurement are set according to the regulations of the selected standard.

| ACP STANDARD |
|-------------------|
| NONE |
| NADC |
| TETRA |
| PDC |
| PHS |
| CDPD |
| CDMA800 FWD |
| CDMA800 REV |
| CDMA1900 FWD |
| CDMA1900 REV |
| W-CDMA FWD |
| W-CDMA REV |
| W-CDMA 3GPP FWD |
| W-CDMA 3GPP REV |
| CDMA2000 MC |
| CDMA2000 DS |
| CDMA ONE 800 FWD |
| CDMA ONE 800 REV |
| CDMA ONE 1900 FWD |
| CDMA ONE 1900 REV |

The following standards can be selected:

NADC (IS-54 B)
 TETRA
 PDC (RCR STD-27)
 PHS (RCR STD-28)
 CDPD
 CDMA800FWD
 CDMA800REV
 CDMA1900REV
 CDMA1900FWD
 W-CDMA FWD
 W-CDMA REV
 W-CDMA 3GPP FWD
 W-CDMA 3GPP REV
 CDMA2000 Multi Carrier
 CDMA2000 Direct Sequence
 CDMA ONE 800 FWD
 CDMA ONE 800 REV
 CDMA ONE 1900 REV
 CDMA ONE 1900 FWD

If the full dynamic range of the analyzer is to be utilized for the W-CDMA measurement (for a power measurement in this standard), the RF attenuation has to be set to 0 dB.

However this is not done automatically to avoid damaging the analyzer input. Instead, a window displaying the following note is shown if one of the W-CDMA standards is selected: 'Attention: For higher dynamic range use *RF ATTEN MANUAL=0dB*.'

The following parameters change according to the standard selected:

- channel spacing
- channel bandwidth
- modulation filter
- resolution bandwidth
- video bandwidth
- detector

Trace Maths and Trace Averaging are switched off.

The reference level is not changed when a standard is selected. It has to be set for an optimum dynamic range so that the signal maximum is in the vicinity of the reference level.

The basic setting *ACP STANDARD NONE*.

IEC/IEEE-bus command

```
:CALCulate<1|2>:MARKer<1...4>:FUNction:POWer:PRESet
  NONE |NADC |TETRA |PDC |PHS |CDPD |F8CDma |R8CDma|
  F19Cdma |R19Cdma |FWCDma | RWCDma |FW3Gppcdma |
  RW3Gppcdma |M2CDma |D2CDma |FO8Cdma |RO8Cdma |
  FO19cdma |RO19cdma
```

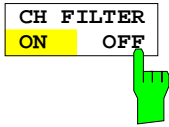

The *CH FILTER ON/OFF* softkey switches a modulation filter for the channel power and adjacent channel power measurement on or off.

When selecting the digital mobile-radio standards NADC, TETRA and W-CDMA 3 GPP (FWD and REV) using the *ACP STANDARD* softkey, the softkey is automatically set to ON. When the other standards are selected, weighting is not selectable and the softkey is not available.

CH FILTER ON The channel bandwidth is defined by the filter weighting alone. Therefore, the *CHANNEL BANDWIDTH* softkey cannot be operated.

The activated modulation filter influences the channel and adjacent channel power measurement.

Within the definition range of the filter, the individual pixels are weighted with the calculated filter attenuation as a function of the spacing to the channel center. The weighted display points are then added to the total channel power.

CH FILTER OFF No modulation filter is switched on.

IEC/IEEE-bus command

```
:CALCulate<1|2>:MARKer<1..4>:FUNCTION:POWER:CFIL ON|OFF
```

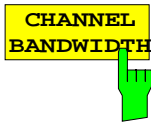

The *CHANNEL BANDWIDTH* softkey opens an entry window for setting the channel bandwidth for the transmission channel and the corresponding adjacent channels.

For all channels, the default setting is 14 kHz.

| ACP CHANNEL BW | |
|----------------|-----------|
| CHAN | BANDWIDTH |
| CH | 14 kHz |
| ADJ | 14 kHz |
| ALT1 | 14 kHz |
| ALT2 | 14 kHz |

Note: *If the bandwidth of one channel is changed, the new value is also assigned to all subsequent channels in the table. The bandwidths for the individual channels can be set independently, however, by overwriting the table from the top to the bottom.*

IEC/IEEE-bus commands

```
: [SENSE<1|2>:]POWER:ACHannel:BWIDth[:CHANnel] 24KHZ
```

```
: [SENSE<1|2>:]POWER:ACHannel:BWIDth:ACHannel 24KHZ
```

```
: [SENSE<1|2>:]POWER:ACHannel:BWIDth:ALternate<1|2> 24KHZ
```

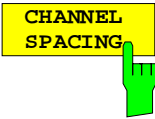

The *CHANNEL SPACING* softkey opens a table for defining the channel spacing. The channel spacing is the spacing of the center frequency of a given channel relative to the center of the transmission channel.

The default setting for channel spacing is 20 kHz.

| CHANNEL SPACING | |
|-----------------|---------|
| CHAN | SPACING |
| ADJ | 20 kHz |
| ALT1 | 40 kHz |
| ALT2 | 60 kHz |

Note: Channel spacings can be selected separately for each channel. If a spacing value is changed in the table, the following values are changed automatically.

IEC/IEEE-bus commands

```
:[SENSe<1|2>:]POWer:ACHannel:SPACing[:UPPer] 24KHZ
:[SENSe<1|2>:]POWer:ACHannel:SPACing:ACHannel 24KHZ
:[SENSe<1|2>:]POWer:ACHannel:SPACing:ALT<1|2> 24KHZ
```

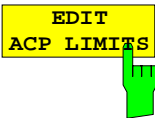

The *EDIT ACP LIMITS* opens a table for defining the limits for ACP-measurement.

| ACP LIMITS | | | |
|------------|-------|---------------------|---------------------|
| CHAN | CHECK | LOWER CHANNEL LIMIT | UPPER CHANNEL LIMIT |
| ADJ | ✓ | -50 dB | -50 dB |
| ALT1 | ✓ | -60 dB | -60 dB |
| ALT2 | | | |

The limit values are defined either in units of dB (for *CP/ACP REL*) or in dBm (for *CP/ACP ABS*).

Note: Measured values that exceed one of the limits are marked with an preceding asterisk.

IEC/IEEE-bus commands

```
:CALCulate<1|2>:LIMit<1..8>:ACP:ACHannel 30DB, 30DB
:CALCulate<1|2>:LIMit<1..8>:ACP:ACHannel:STATE ON|OFF
:CALCulate<1|2>:LIMit<1..8>:ACP:ALT<1|2> 30DB, 30DB
:CALCulate<1|2>:LIMit<1..8>:ACP:ALT<1|2>:STATE ON|OFF
```

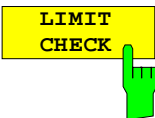

The *LIMIT CHECK* softkey switches on or off the limit check of the ACP measurement.

IEC/IEEE-bus commands

```
:CALCulate<1|2>:LIMit:ACPower[:STATE] ON | OFF
:CALCulate<1|2>:LIMit<1..8>:ACP:ACHannel:RESult?
:CALCulate<1|2>:LIMit<1..8>:ACP:ALTernate<1|2>:RESult?
```

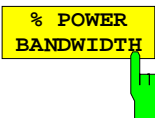

The *% POWER BANDWIDTH* softkey opens an entry window for defining the percentage of the power with respect to the total power in the displayed frequency range. This defines the occupied bandwidth (percent of the total power).

The permitted range is 10 % - 99,9 %

IEC/IEEE-bus command :[SENSe<1|2>:]Power:BANDwidth 99PCT

Channel Power Measurement

The *CHANNEL POWER* measurement is performed by an integration of the measurement points within the channel bandwidth. The channel is marked by two vertical lines to the left and to the right of the center frequency as defined by the channel bandwidth (see Fig. 4-4).

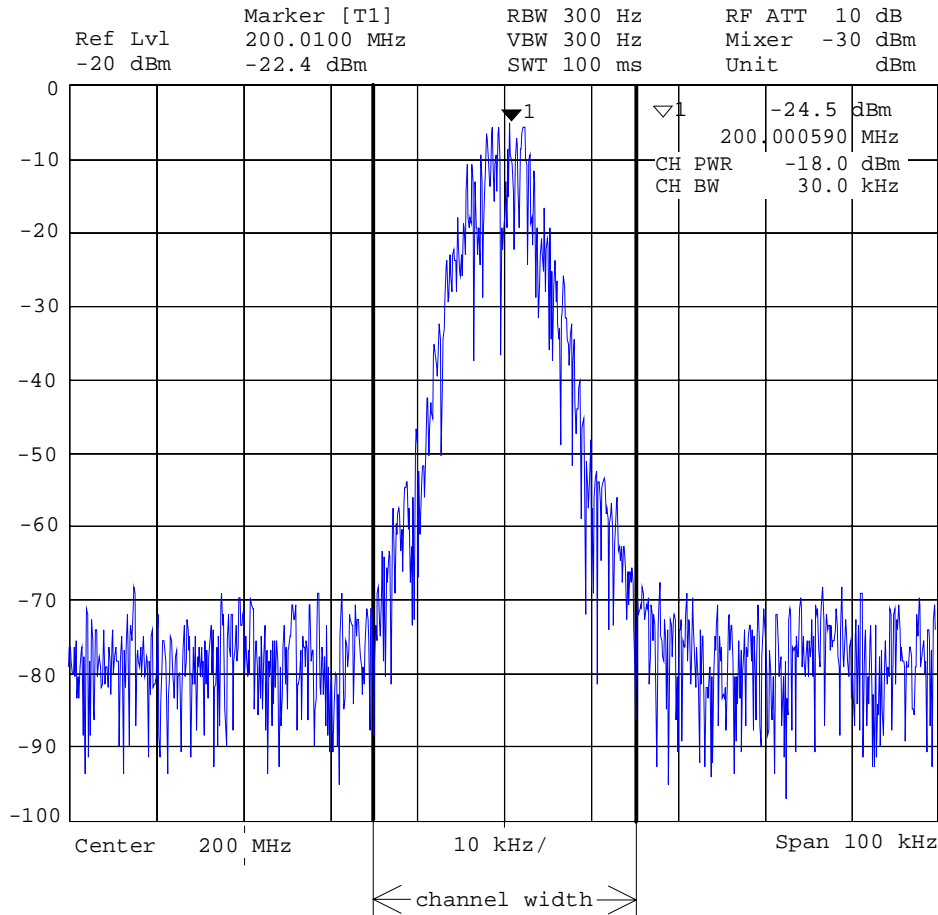
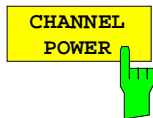

Fig. 4-4 Determination of the channel width

MARKER NORMAL menu:



The *CHANNEL POWER* softkey initiates the calculation of the power in the measurement channel. The display takes place in the units of the y axis, e.g., in dBm, dB μ V.

The calculation is performed by summing the power at the pixels within the specified channel.

The measurement is either absolute or relative to a reference power (see the *CP/ACP ABS/ REL* softkey).

IEC/IEEE-bus commands

```
:CALCulate<1|2>:MARKer<1..4>:FUNC:POW:SElect CPower;
:CALCulate<1|2>:MARKer<1..4>:FUNC:POW:RESult? CPower;
:CALCulate<1|2>:MARKer<1..4>:FUNC:POW[:STATe] OFF
```

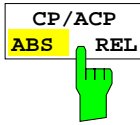
The *CP/ACP ABS/REL* softkey (Channel Power/Adjacent Channel Power Absolute /Relative) switches between an absolute and relative display of the power measured in the channel or adjacent channel.

Channel power measurement

CP ABS The absolute value of the power is displayed in the unit of the Y axis, eg in dBm, dBV.

CP REL The power of a freely selected channel is measured. This power is set in relation to the power of a reference channel. The reference channel power is selected beforehand using the *SET CP REFERENCE* softkey, ie:

1. Declare the power in the currently measured channel as the reference value using the *SET CP REFERENCE* softkey.
2. Set the channel of interest by changing the channel frequency (FSE center frequency).

In case of linear scale of the Y axis the relative power (CP/CP_{ref}) of the new channel is displayed in addition to the reference channel. In case of dB scale, the logarithmic ratio $20 \times \log(CP/CP_{ref})$ is displayed.

Therefore, the relative channel power measurement can also be used for universal adjacent channel power measurements.

Example:

Measurement of the 1597-QCDMA adjacent channel power. The useful channel and the adjacent channels have different bandwidths (1.23 MHz or 30 kHz).

Adjacent channel power measurement

The power of the adjacent channels is measured. The reference value is the power of the useful channels (see measurement of the adjacent channel power). The useful channel is marked by two vertical lines that are labelled with C_0 .

ACP ABS The powers of the useful channel and of the adjacent channels are displayed as absolute values in the unit of the Y axis.

ACP REL The logarithmic ratio $20 \times \log(CP/CP_0)$ of the powers of the adjacent channels to the useful channel is displayed

The softkey is not available for *OCCUPIED PWR BANDWIDTH*, *C/N* and *C/N0*

IEC/IEEE-bus command

```
: [SENSe<1 | 2> : ]POWER:ACHannel:MODE ABS | REL
```

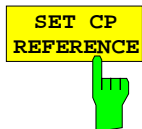

The *SET CP REFERENCE* softkey sets the reference value to the currently measured channel power for an activated *CHANNEL POWER* power measurement,.

IEC/IEEE-bus command

```
: [SENSe<1 | 2> : ]POWER:ACHannel:REF:AUTO ONCE
```

Signal / Noise Power Measurement

MARKER NORMAL menu:

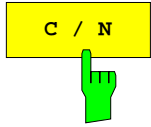

The C/N (Carrier to Noise) softkey calculates the ratio of carrier power to noise power and the power of interference signals in the channel defined under *POWER MEAS SETTING*. For the measurement, a marker must be set to the carrier of interest.

The unit of C/N is dB when the display is logarithmic. When the display is linear, C/N is shown without a unit.

IEC/IEEE-bus commands

```
:CALCulate<1|2>:MARKer<1...4>:FUNction:POW:SElect CN;
:CALCulate<1|2>:MARKer<1...4>:FUNction:POW:RESult? CN;
:CALCulate<1|2>:MARKer<1...4>:FUNction:POW[:STATe] OFF
```

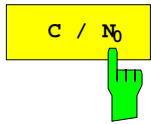

The C/N_0 softkey starts the C/N_0 measurement.

In contrast to the C/N measurement, C/N_0 calculates the ratio of carrier power to noise and interference signals based on a 1 Hz bandwidth in the channel defined under *POWER MEAS SETTING*.

The unit of C/N_0 is dB/Hz when the display is logarithmic and 1/Hz when the display is linear.

IEC/IEEE-bus commands

```
:CALCulate<1|2>:MARKer<1...4>:FUNction:POW:SElect CN0;
:CALCulate<1|2>:MARKer<1...4>:FUNction:POW:RESult? CN0;
:CALCulate<1|2>:MARKer<1...4>:FUNction:POW[:STATe] OFF
```

Measurement procedure:

1. Activate a marker and position it to the peak of the carrier signal (e.g., with the *Marker -> Peak* softkey).
2. Select With the desired frequency range (channel) with the *FREQUENCY CENTER* and *CHANNEL BANDWIDTH (POWER MEAS SETTING sub-menu)* softkeys.
3. Press the C/N or C/N_0 softkey. The marker is set to reference fixed and activates each measurement. It must be observed that the carrier is either located outside of the measurement channel or turned off at the UUT (Unit Under Test).
4. Press the *ADJUST CP SETTINGS* softkey to active the default settings with modified channel parameters.

The measurement values for C/N or C/N_0 are displayed in the marker info field.

Notes: – If no carrier marker was set, only N or N_0 with the appropriate units is displayed.
 – Is the carrier located inside the measurement channel, $C/C+N$ or $C/C+N_0$ will be displayed

Example:

The signal-to-noise ratio of the carrier ($f = 199.9$ MHz) in the channel with +100 kHz separation from 200 MHz (channel center frequency) is to be measured. The channel bandwidth is 150 kHz.

1. Using the *CENTER* key, set the center frequency to the channel center frequency 200 MHz.
2. Using the *SPAN* key, set the span, e.g., to 1 MHz (carrier must be visible).
3. Using the *MARKER NORMAL* key, activate *MARKER 1* (If Marker 1 was not yet active, the function *MARKER*→*PEAK* is automatically executed. In this case, skip step 4.)
4. Using the *MARKER*→*PEAK* key, set *MARKER 1* on the carrier (assumption: the 200 MHz carrier has the highest level in the selected span).
5. Press the *MARKER NORMAL* key and change to the left-hand supplementary menu.
6. Using the *POWER MEAS SETTING* softkey, call the sub-menu for defining the measurement channel.
7. Using the *CHANNEL BANDWIDTH* softkey, set the bandwidth to 150 kHz (The channel spacing does not need to be entered for this measurement). Then press \uparrow menu change key.
8. Using the *C/N* softkey, start the C/N measurement. In the marker info field, the outputs *CHANNEL CENTER*, *CHANNEL BANDWIDTH* as well as the corresponding C/N measurement values appear. *MARKER 1* is also set to reference fixed.
9. Using the *ADJUST CP SETTINGS* softkey, activate the default settings with modified channel parameters (channel bandwidth = 150kHz) for the correct C/N measurement (span = $2 \times$ channel bandwidth = 300 kHz, RBW = 3 kHz, VBW = 10 kHz, detector: sampling).

Two vertical lines mark the channel $200 \text{ MHz} \pm 75 \text{ kHz}$ in which the noise measurement is performed (see Fig.4-5). The reference value is the measurement from *MARKER 1* (Reference Fixed).

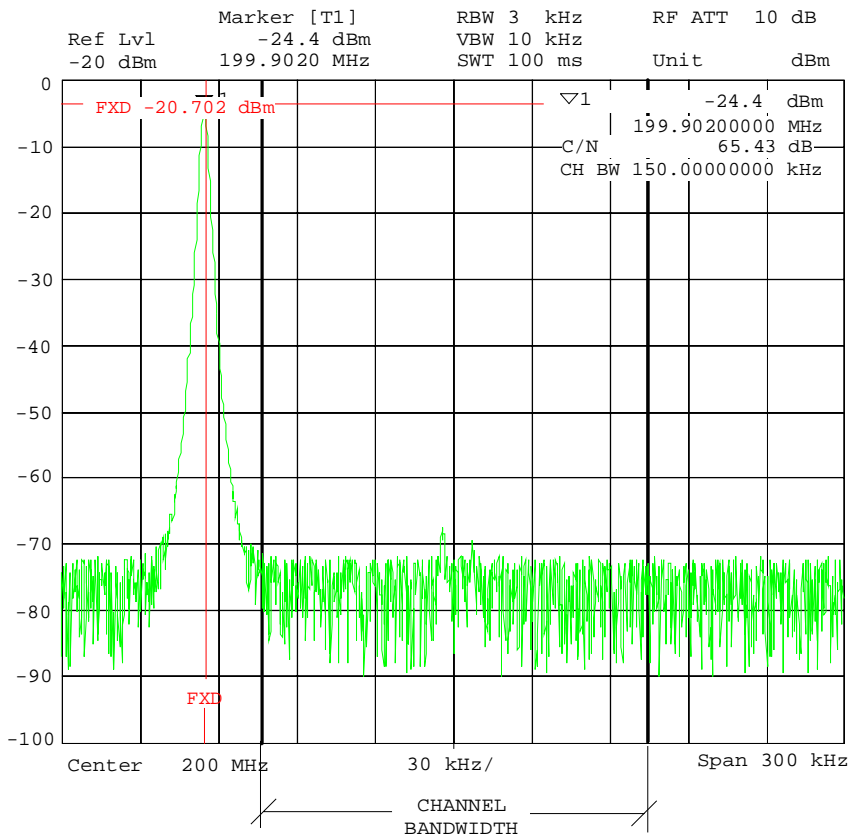
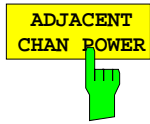

Fig.4-5 Example: measurement of the signal/noise power

Adjacent Channel Power

MARKER NORMAL menu:



The *ADJACENT CHAN POWER* softkey starts the measurement of the adjacent channel power.

The *ADJACENT CHAN POWER* measures the power which the transmitter delivers to the two adjacent channels (upper channel , lower channel). The measurement values are displayed according to the setting of the *CH/ACD ABS/REL* softkey as absolute values in the scale of the X axis (see Fig.4-6) or as a logarithmic ratio of adjacent channel to useful channel in dB ($20 \times \log (CP/CP_0)$).

If the power of the other neighbouring channels is to be measured in addition to the adjacent channel power, the number of adjacent channels can be extended (on one side only) using *SET NO. OF ADJ CHAN'S* in the submenu *POWER MEAS SETTINGS*.

IEC/IEEE-bus commands

```
:CALCulate<1|2>:MARKer<1...4>:FUNCTION:POW:SElect ACP;
:CALCulate<1|2>:MARKer<1...4>:FUNCTION:POW:RESult? ACP;
:CALCulate<1|2>:MARKer<1...4>:FUNCTION:POW[:STATe] OFF
```

A prerequisite for the correct measurement of the adjacent channel power is the correct setting of the FSE center frequency, the channel bandwidth and the channel spacing. The *CHANNEL SPACING* and *CHANNEL BANDWIDTH* are defined in the *POWER MEAS SETTINGS* sub-menu.

For an activated measurement of adjacent channel power, the analyzer itself optimally sets all other values (span, resolution bandwidth, detector, etc.) after the *ADJUST CP SETTINGS* softkey is pressed. The carrier power in the utilised channel, the power (absolute or relative to the utilised channel) in the upper and lower adjacent channels as well as the largest of the two power values and the channel raster with channel spacing and bandwidth are displayed as the result of the measurement. The C0 lines mark the bandwidth of the carrier channel. Other unlabelled frequency lines mark the adjacent channels (see Fig.4-6). With *SET NO. OF ADJ CHAN'S* 2 selected, the other two neighbouring channels (1st Alternate Channels) are displayed as well, with *SET NO. OF ADJ CHAN'S* 3 selected, an additional channel each (2nd Alternate Channels).

The measurement values are updated and displayed until the *ADJACENT CHAN POWER* softkey is pressed again and the measurement of the adjacent channel power is stopped.

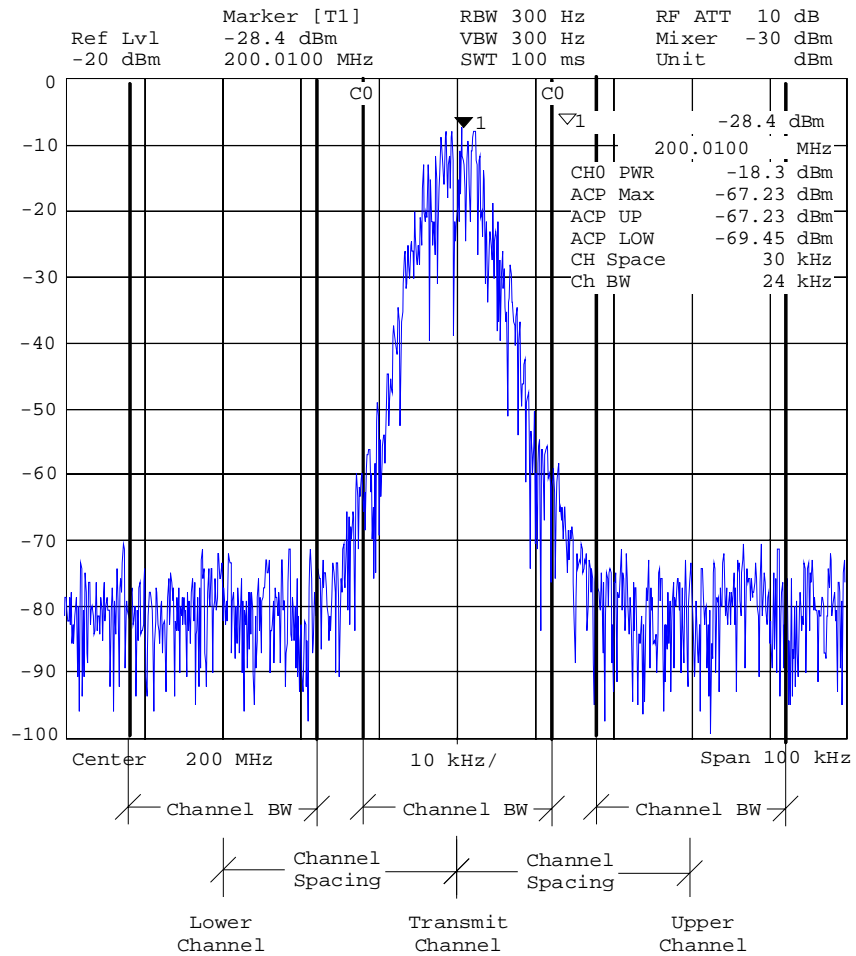

Fig.4-6 Measurement of the adjacent channel power.

If the limit check is activated for ACP measurements, the result of the limit check (PASSED/FAILED) is displayed as well as an asterisk preceding each measured ACP power that exceeded one of the limits.

Note: The limit check is activated and the limits are defined in the POWER MEAS SETTINGS menu.

Occupied Bandwidth Measurement

An important characteristic of a modulated signal is the bandwidth which it occupies. In a radio communications system, for instance, the occupied bandwidth must be limited prevent in adjacent channel interferences. The occupied bandwidth is defined as the bandwidth in which a defined percentage of the total transmitter power is contained. The percentage of the power can be set between 10 and 99% in the FSE.

MARKER NORMAL menu:

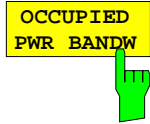

The *OCCUPIED PWR BANDW* (occupied power bandwidth) softkey starts the measurement for determining the occupied bandwidth.

In the spectrum display mode, the bandwidth is determined in which a predefined percentage of the power in the displayed bandwidth is contained. (selectable in the *POWER MEAS SETTINGS* sub-menu with the : % *POWER BANDWIDTH* softkey). The occupied bandwidth is output to the marker display field and marked on the trace with temporary markers.

IEC/IEEE-bus command

```
:CALCulate<1|2>:MARKer<1...4>:FUNction:POW:SElect OBW
:CALCulate<1|2>:MARKer<1...4>:FUNction:POW:RESult? OBW
:CALCulate<1|2>:MARKer<1...4>:FUNction:POW[:STATe] OFF
```

Measurement principle:

For example, the bandwidth is to be found in which 99% of the signal power is contained. The routine calculates first the total power of all displayed points (pixels) of the trace. In the next step, the measurement points from the right edge of the trace are integrated until 0.5% of the total power is reached. Then the FSE integrates, in an analog fashion, from the left edge of the trace until 0.5% of the power is reached. The delta marker is positioned at this point. Thus, 99% of the power is located between the two markers. The difference between the two frequency markers is the occupied bandwidth which is displayed in the marker info field.

A prerequisite for the correct operation of the measurement is that **only** the signal to be measured is visible on the display screen of the FSE. An additional signal would falsify the measurement.

In order to be able to perform correct power measurements, especially for noisy signals, and thus to achieve the correct occupied bandwidth, the selection of the following parameters should be observed:

| | |
|----------|--|
| RBW | << occupied bandwidth (\leq approx. 1/20 of the occupied bandwidth, for voice communications, typ. 300 Hz or 1 kHz) |
| VBW | $\geq 3 \times$ RBW |
| detector | sampling |
| span | ≥ 2 to $3 \times$ occupied bandwidth |

According to the application or other measurement guidelines, it may be necessary or reasonable to average a definite number of sweeps in order to achieve a usable value for the occupied bandwidth.

This is provided by the *TRACE* (1...4) key group and the averaging function. With the *SWEEP COUNT* softkey, the number of averages is defined.

Some measurement instructions (e.g. PDC, RCR, STD-27B) require the occupied bandwidth to be measured by means of a peak detector. In this case, the detector of the FSE must be corrected appropriately.

Parameters for Channel Power Measurements / Configuration

For the correct measurement of channel power, C/N, C/N0, adjacent channel power and occupied bandwidth, it is recommended that an automatic optimisation of the analyzer settings be performed after enabling the corresponding measurement and selecting the channel configuration (channel power settings).

MARKER NORMAL menu:

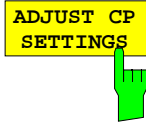

The *ADJUST CP SETTINGS* softkey optimises automatically the settings of the analyzer for the selected power measurement (see below).

All relevant analyzer settings for a power measurement within a defined frequency range (channel bandwidth) are optimally set including:

- span
- resolution bandwidth
- video bandwidth
- detector

dependent upon the channel configuration (channel bandwidth and, if needed, channel spacing).

The trace mathematical functions and trace averaging are switched off.

The reference level is not influenced by the automatic optimisation routine. The reference level is to be so adjusted that the signal maximum is located near the reference level.

The optimisation is performed only once, however, if necessary, the instrument settings may be changed later.

IEC/IEEE-bus command
`: [SENSe<1|2>:]POWER:ACHannel:PRESet ADJust`

Span

The span should cover at least the frequency range that is to be observed. For channel power measurements, C/N and C/N0, this is the channel bandwidth. For adjacent channel power measurements, this is the utilised channel bandwidth and the adjacent channels located within the channel spacing. If the span is large compared to the observed frequency band(s), then only a few points on the trace are available for the measurement.

The *ADJUST CP SETTINGS* softkey sets the span as follows:

| | |
|--|--|
| $2 \times$ channel bandwidth | for channel power, C/N, C/No or |
| $2 \times$ channel spacing + channel width | for adjacent channel power |
| $4 \times$ channel bandwidth | for adjacent channel power and NO. OF ADJ CHAN'S 2 |
| $6 \times$ channel spacing + channel width | for adjacent channel power and NO. OF ADJ CHAN'S 3 |

For measurements of the occupied bandwidth, the span is not influenced.

Resolution bandwidth (RBW)

In order to achieve acceptable speed as well as the necessary selectivity (to suppress spectral components outside of the channel to be measured and, especially adjacent channels), the resolution bandwidth that is selected must not be too narrow or too broad.

If the resolution bandwidth is too narrow, the measurement speed becomes very slow and it is possible that relative spectral components are not displayed (due to the sampling detector necessary for power measurements and the finite number of points).

On the other hand, the resolution bandwidth should not be so broad that, due to insufficient selection, spectral components outside of the observed frequency range (from adjacent channel) falsify the measurement results.

The *ADJUST CP SETTINGS* softkey sets the resolution bandwidth (RBW) dependent upon the channel bandwidth as follows:

$RBW \leq 1/40$ of the channel bandwidth. The maximum possible RBW, with due regard to the 1, 2, 3, 5 step size and the requirement $RBW \leq 1/40$ will be selected.

The RBW is not influenced by measurements of the occupied bandwidth.

Video bandwidth (VBW) Since a power measurement of the noise components is also necessary (otherwise, errors occur due to the logarithmic characteristics of the spectrum analyzer), the video bandwidth should be selected to be substantially larger than the resolution bandwidth.

The *ADJUST CP SETTINGS* softkey adjusts the video bandwidth (VBW) dependent upon the channel bandwidth as follows:

$VBW \geq 3 * RBW$. The minimum VVB with regard to the available 1, 2, 3, 5 step size is selected.

Grid scale The *ADJUST CP SETTINGS* softkey sets the grid scale to the 100-dB range. Thereby, a wide dynamic range in channel power measurements is achieved.

Detector The *ADJUST CP SETTINGS* softkey selects the sampling detector. The sampling detector is to be selected, above all, for correct power measurements of noisy signals within the observed frequency range.

Marker Step Size

DATA VARIATION – STEP menu:

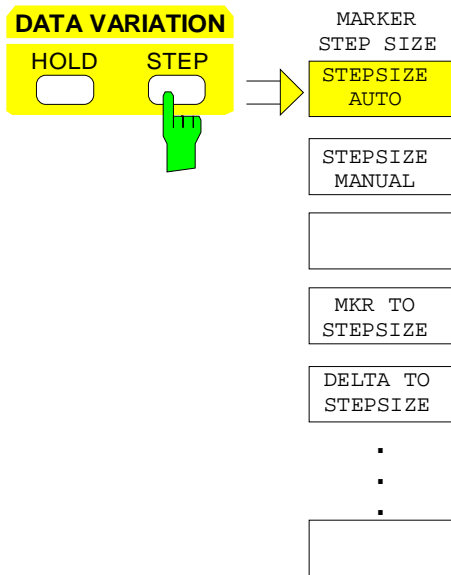

The *STEP* key in the *DATA VARIATION* key group opens a menu to match the marker step size to each individual application. In order to change the step size, the marker entry mode must already be active.

Control is returned to the *MARKER NORMAL* menu via the menu key .



The *STEPSIZE AUTO* softkey sets the marker step size to *AUTO*. In this case, the step size is exactly 10% of the grid. A one-raster movement of the roll-key corresponds to one pixel.

STEPSIZE AUTO is the default setting.

IEC/IEEE-bus command

```
:CALCulate<1|2>:MARKer<1..4>:STEP:AUTO ON|OFF
```



The *STEPSIZE MANUAL* softkey activates the entry window for defining a fixed value for the marker step size.



Pressing the step key shifts the marker position by the selected step size. The resolution of the roll-key is always one pixel per raster.

IEC/IEEE-bus command

```
:CALCulate<1|2>:MARKer<1..4>:STEP 10KHZ
```



The *MKR TO STEPSIZE* softkey sets the marker step size to the current marker frequency or marker time.

In the frequency domain, this function is well suited to harmonic measurements. The marker is set to the largest signal using the peak search function. After activation of the *MKR TO STEPSIZE* function, the marker is set to the corresponding harmonic of the signal each time the cursor key  or  is pressed when entering the marker position (see also Chapter 2, "Measurement Examples").

IEC/IEEE-bus command

```
:CALCulate<1|2>:MARKer<1..4>:FUNction:MSTep
```



The *DELTA TO STEPSIZE* softkey sets the marker step size to the difference between the reference marker and the last active delta marker.

The softkey is only available when at least one delta marker is enabled.

IEC/IEEE-bus command --

Delta Markers – DELTA Key

The delta marker.s are used to measure a level or frequency referred to a reference marker. They are always referenced to the marker whose position was last changed. A delta marker is displayed as an empty \triangle symbol. The reference marker is displayed as a filled \blacktriangledown symbol.

MARKER DELTA menu:

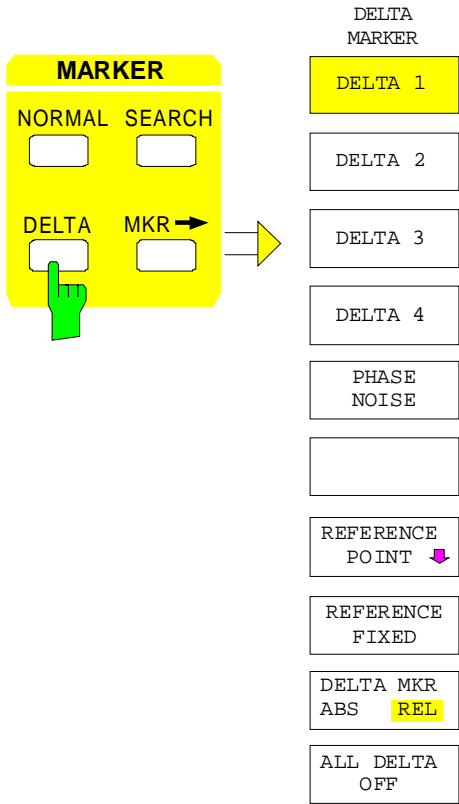

The *DELTA* key switches a delta marker on and calls the menu for its control. If no marker is enabled, *MARKER 1* is automatically activated when the delta marker is switched on. The delta marker activated to entry mode is shown on the display screen as a filled \blacktriangle symbol.

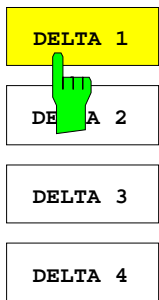

The *DELTA 1 to 4* softkeys are used to enable delta markers 1...4. The control of the delta markers corresponds to that of the markers. After a delta marker has been enabled, all entries are now applicable to this marker. The main marker must be activated anew if its position is to be changed.

The delta marker field on the display screen contains the delta marker number, the difference frequency from the delta marker to reference marker and the level difference between the active delta markers and reference markers.

The indicated differences are, in general, referred to the reference marker. If the *PHASE NOISE* or *REFERENCE FIXED* functions are enabled, the reference values under *REFERENCE POINT* are applicable.

IEC/IEEE-bus commands

```
:CALCulate<1|2>:DELTAmarker<1..4> ON|OFF
:CALCulate<1|2>:DELTAmarker<1..4>:X 10.7MHZ
:CALCulate<1|2>:DELTAmarker<1..4>:X:REL?
:CALCulate<1|2>:DELTAmarker<1..4>:Y
```

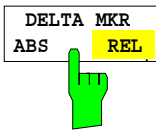

The *DELTA ABS REL* softkey switches between relative and absolute entry modes for the delta-marker frequency.

In the *REL* position, the delta marker frequency is entered relative to the reference marker. In this case, the entry mode for the delta-marker frequencies is also relative.

In the *ABS* position, the entry of the delta-marker frequency is in terms of absolute frequency.

The default setting is *REL*.

IEC/IEEE-bus command

```
:CALCulate<1|2>:DELTAmarker<1..4>:MODE ABS | REL
```



The *ALL DELTA OFF* softkey switches off all active delta markers and any associated functions (e.g. *REFERENCE FIXED*, *PHASE NOISE*).

IEC/IEEE-bus command

```
:CALCulate<1|2>:DELTAmarker<1..4>:AOFF
```

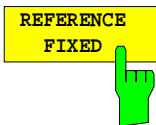

The *REFERENCE FIXED* softkey enables/disables relative measurements with respect to a fixed, measurement-curve-independent reference value.

The information in the delta-marker field on the display screen is referenced to this fixed reference value. For the generation of the marker lists using *MARKER INFO* list, the delta markers are also output relative to a fixed reference. In the lists, the *REFERENCE POINT* is tagged by the number of the reference marker (only one enabled)

When *REFERENCE FIXED* is enabled, the current settings of the reference marker become the reference values. If no marker is active, *MARKER 1* (with peak search) is activated. After transferring the reference values, all markers are deleted, and the active delta marker is set to the position of the reference value. Additional delta markers can be switched on.

The reference value can be subsequently changed

1. by shifting it in the *REFERENCE POINT* sub-menu.
2. by starting a search:

In the *MARKER NORMAL* menu the *REF POINT* is handled as a reference marker (even though it is not bound to the trace). This means, that it will be shown as enabled and can also be changed in position. The co-ordinates of the *REF POINT* are overwritten by the marker values (they lie, by definition, on the trace). Thus, it is possible, even for an enabled *REFERENCE FIXED*, to define a new reference point function with search functions.

The *REFERENCE FIXED* function is particularly useful for measurements which are performed relative to a reference signal that is not available during the whole measurement time (e. g. harmonics measurements, see chapter "Measurement Example").

IEC/IEEE-bus command

```
:CALCulate<1|2>:DELTAmarker<1..4>:FUNCTION:FIXed ON|OFF
```

MARKER DELTA- REFERENCE POINT submenu:

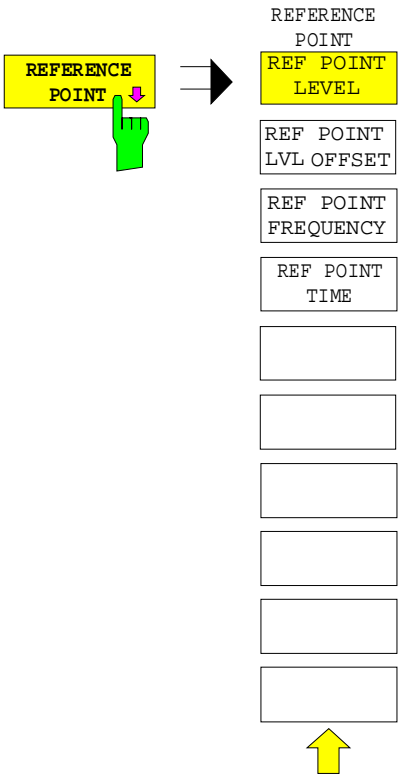

The *REFERENCE POINT* softkey opens a sub-menu in which the reference value the *REFERENCE FIXED* and *PHASE NOISE* functions can be modified.

The position of the reference value is indicated by two additional display lines (horizontal and vertical). In addition, an offset level may be defined which is added to each difference during output.

The softkey is only available when the *REFERENCE FIXED* or *PHASE NOISE* function is switched on.

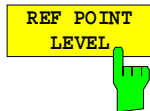

The *REF POINT LEVEL* softkey activates an entry box for setting the reference level relevant to the *REFERENCE FIXED* or *PHASE NOISE* functions.

IEC/IEEE-bus command

```
:CALCulate<1|2>:DELT<1..4>:FUNC:FIXed:RPoint:Y -10DBM
```

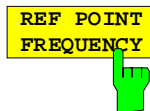

The *REF POINT FREQUENCY* softkey activates the entry box for the input of a reference frequency for the *REFERENCE FIXED* or *PHASE NOISE* functions.

IEC/IEEE-bus command

```
:CALCulate<1|2>:DELT<1..4>:FUNC:FIXed:RPoint:X 10.7MHZ
```

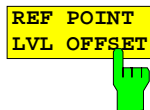

The *REF POINT LVL OFFSET* softkey activates the entry box for the entry of an additional offset level during output when the *REFERENCE FIXED* or *PHASE NOISE* functions are enabled.

The offset level is set to 0 dB when the *REFERENCE FIXED* or *PHASE NOISE* functions are switched on.

IEC/IEEE-bus command

```
:CALCulate<1|2>:DELT<1..4>:FUNC:FIX:RPO:Y:OFFSet 10DB
```



The *REF POINT TIME* softkey activates the entry box for the input of a reference time for the *REFERENCE FIXED* function in the time domain (span = 0).

The entry of a reference time for the *PHASE NOISE* function is not possible.

IEC/IEEE-bus command

```
:CALCulate<1|2>:DELT<1..4>:FUNC:FIXed:RPoint:X 100ms
```

Phase Noise Measurement

MARKER DELTA menu:

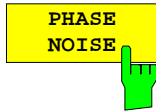

The *PHASE NOISE* softkey switches the *PHASE NOISE* function on/off.

When *PHASE NOISE* measurement is switched on, the frequency and level of the reference marker are used as fixed reference values, i.e. the *REFERENCE FIXED* function is activated.

The difference between this reference point and the active delta markers is determined. The correction factors for bandwidth and the logarithmic converter are automatically taken into account. The sampling detector is automatically selected to allow the effective noise power to be displayed. The measured values are displayed in the delta marker field in units of dBc/Hz.

If several delta markers are enabled, only the measurement value output of the active marker is shown in the marker field. Using *MARKER INFO* and *MARKER LIST* the measurement data of all delta markers can be displayed.

If no marker is present when the *PHASE NOISE* function is enabled, *MARKER 1* is automatically switched on (peak search), and the marker values are saved as reference values. The reference value can be changed later in the *NORMAL* menu, *SEARCH* menu or *REFERENCE POINT* sub-menu (see *REFERENCE FIXED* softkey).

Turning on an additional marker causes the *PHASE NOISE* function to be disabled.

IEC/IEEE-bus commands

```
:CALCulate<1|2>:DELTAmarker<1..4>:FUNC:PNOise ON | OFF
:CALCulate<1|2>:DELTAmarker<1..4>:FUNC:PNOise:RESult?
```

Delta-Marker Step Size - *STEP* Key

STEP-DELTA STEP menu:

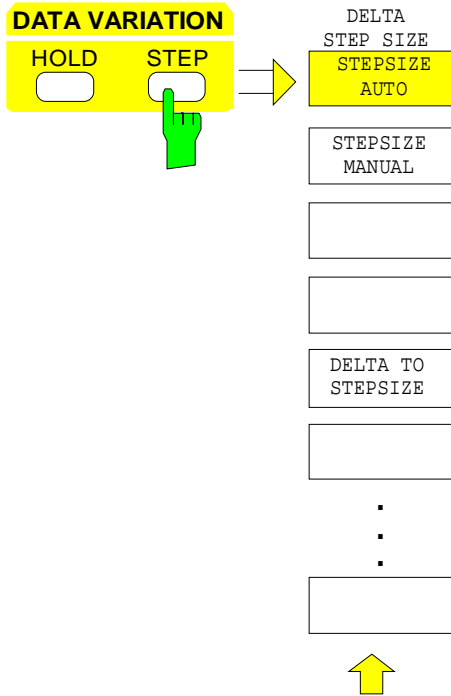

The *STEP* key in the *DATA VARIATION* key group opens a menu to match the step size of the individual delta markers to the specific application. In order to change the step size, the entry mode for a delta marker must already be active.

Control is returned to the *DELTA MARKER* menu via the menu key .

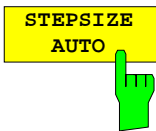

The *STEPSIZE AUTO* softkey sets the delta marker step size to *AUTO*. In this case, the step size of the delta marker is exactly 10% of the grid. The roll-key corresponds to 1/500, i.e., for each rotational pulse, the delta marker is shifted one pixel position.

IEC/IEEE-bus command
`:CALCulate<1|2>:DELTAmarker<1..4>:STEP:AUTO ON | OFF`



The *STEPSIZE MANUAL* softkey permits the entry of a fixed value for the delta marker step size.

Pressing the step-key shifts the marker position by the selected step size. The roll-key resolution, however, always remains constant at 1 pixel.

IEC/IEEE-bus command --



The *DELTATO STEPSIZE* softkey sets the delta marker step size to a quantity equal to the difference between the delta and reference markers.

The softkey is only presented when at least one delta marker is switched on.

IEC/IEEE-bus command
`:CALCulate<1|2>:DELTAmarker<1..4>:STEP 10HZ`

Search Functions – SEARCH Key

The FSE offers numerous functions useful for peak/min. peak searching. The search functions can be used for marker as well as delta marker functions.

The setups applicable to the available search functions are performed in the *MARKER-SEARCH* menu.

The search functions are always related to the currently active marker. If the *SEARCH* key is pressed while the marker entry mode is active, then all search functions are related to the current reference marker. If the entry mode of a delta marker is active, then the functions will be applied to the corresponding delta marker. For the case where no marker is active, *MARKER 1* will be automatically enabled (with peak search). The *ACTIVE MKR / DELTA* softkey allows toggling between the active marker and the active delta marker.

If the threshold line is turned on, the peak/min. search functions will only evaluate signals which have a level above/below the selected threshold. In addition, the search range can also be limited (*SEARCH LIM ON/OFF* softkey) by the frequency/time lines (*FREQUENCY LINE 1/2, TIME LINE 1/2*).

For all peak search functions, the first local oscillator is omitted at 0 Hz if it happens to be displayed.

In the time domain display, the summary markers can be activated and set in addition to the search functions in menu *MARKER-SEARCH*.

MARKER SEARCH menu:

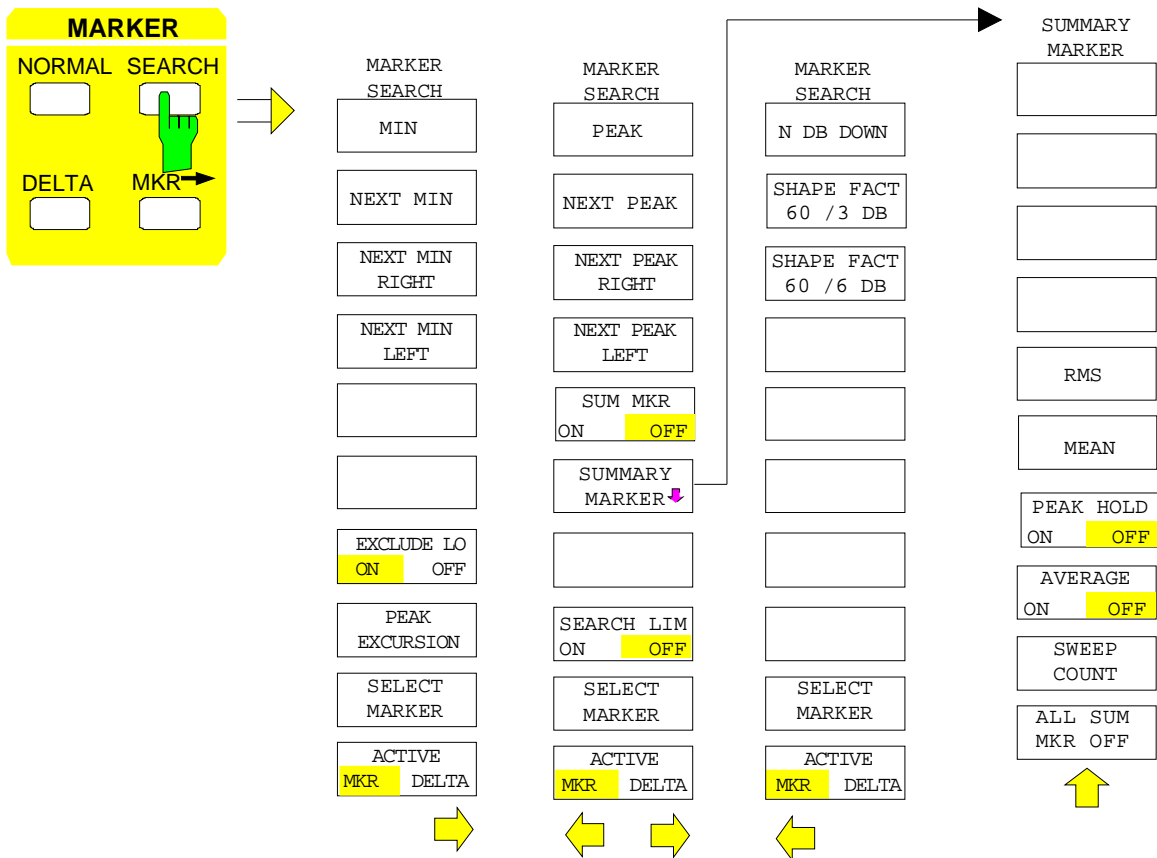

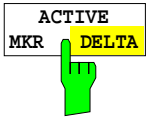

The *ACTIVE MKR / DELTA* softkey toggles between the active marker and the active delta marker.

If *DELTA* is illuminated, the following search functions are performed with the active delta marker.

Note: *Switching between marker and delta marker entry modes may also be performed using the NORMAL and DELTA keys.*

IEC/IEEE-bus command --



The *SELECT MARKER* softkey activates the selection of the marker/delta markers. The selection box lists the currently enabled markers/delta markers.

| MARKER SELECT | DELTA SELECT |
|---------------|--------------|
| MARKER 1 | ✓ DELTA 1 |
| MARKER 3 | DELTA 2 |
| MARKER 4 | DELTA 3 |

IEC/IEEE-bus command --

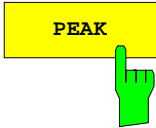

The *PEAK* softkey sets the active marker/delta marker to the maximum displayed value on the corresponding trace.

IEC/IEEE-bus commands
 :CALCulate<1 | 2>:MARKer<1..4>:MAXimum
 :CALCulate<1 | 2>:DELTamarker<1..4>:MAXimum

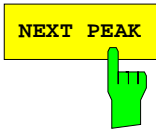

The *NEXT PEAK* softkey sets the active marker/delta marker to the trace value next in magnitude after the peak.

IEC/IEEE-bus commands
 :CALCulate<1 | 2>:MARKer<1..4>:MAX:NEXT
 :CALCulate<1 | 2>:DELTamarker<1..4>:MAX:NEXT

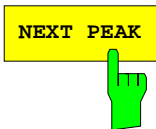

The *NEXT PEAK RIGHT* softkey sets the active marker to the next peak to the right of the current marker position.

IEC/IEEE-bus commands
 :CALCulate<1 | 2>:MARKer<1..4>:MAX:RIGHT
 :CALCulate<1 | 2>:DELTamarker<1..4>:MAX:RIGHT



The *NEXT PEAK LEFT* softkey sets the active marker to the next peak to the left of the current marker position.

IEC/IEEE-bus commands
 :CALCulate<1 | 2>:MARKer<1..4>:MAX:LEFT
 :CALCulate<1 | 2>:DELTamarker<1..4>:MAX:LEFT

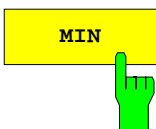

The *MIN* softkey sets the active marker to minimum displayed value on the corresponding trace.

IEC/IEEE-bus commands
 :CALCulate<1 | 2>:MARKer<1..4>:MIN
 :CALCulate<1 | 2>:DELTamarker<1..4>:MIN

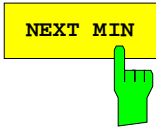

The *NEXT MIN* softkey sets the active marker to the next higher of the low peaks on the corresponding trace.

IEC/IEEE-bus commands

```
:CALCulate<1 | 2>:MARKer<1..4>:MIN:NEXT
:CALCulate<1 | 2>:DELTAmarker<1..4>:MIN:NEXT
```

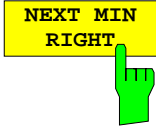

The *NEXT MIN RIGHT* softkey set the active marker to the next low peak to the right of the current marker position.

IEC/IEEE-bus commands

```
:CALCulate<1 | 2>:MARKer<1..4>:MIN:RIGHT
:CALCulate<1 | 2>:DELTAmarker<1..4>:MIN:RIGHT
```

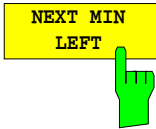

The *NEXT MIN LEFT* softkey sets the active marker to the next low peak to the left of the current marker position.

IEC/IEEE-bus command

```
:CALCulate<1 | 2>:MARKer<1..4>:MIN:LEFT
:CALCulate<1 | 2>:DELTAmarker<1..4>:MIN:LEFT
```

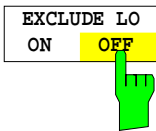

The *EXCLUDE LO ON/OFF* softkey switches between a restricted (*ON*) and an unrestricted search range (*OFF*).

ON Because of non-ideal input mixer, the first LO of any analyzer can be seen at 0 Hz. The search functions can possibly respond to this LO level, in particular in the preset setting (FULL SPAN). To prevent this, the search range is restricted according to the following formula:

$$\text{Search range} \geq 6 \times \text{resolution bandwidth}$$

OFF No restriction on the search range. The search functions find also signals below the frequency limit quoted above.

IEC/IEEE-bus command

```
:CALCulate<1 | 2>:MARKer<1..4>:LOEXclude ON|OFF
```

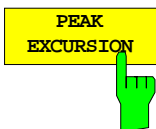

The *PEAK EXCURSION* softkey activates the entry box which sets the minimum amount a signal level must decrease/increase before it is recognised by the search functions (except *PEAK* and *MIN*) as a maximum or minimum.

Input values from 0 dB to 80 dB are allowed with a resolution of 0.1 dB.

IEC/IEEE-bus command

```
:CALCulate<1 | 2>:MARKer<1..4>:PEXCursion 10DB
```

The peak excursion is preset to 6 dB. This is sufficient for the functions *NEXT PEAK* (or *NEXT MIN*) as the next smallest (or next largest) signal is always searched for.

Functions *NEXT PEAK LEFT* and *NEXT PEAK RIGHT* (or *NEXT MIN LEFT* and *NEXT MIN RIGHT*) search for the next relative maximum (or minimum) irrespective of the current signal amplitude.

As for wide bandwidths, the intrinsic noise of the FSE may equal the 6 dB level change preset for *PEAK EXCURSION* and so noise peaks are identified as signal peaks

In this case, a value for *PEAK EXCURSION* which is higher than the difference between the maximum and minimum noise display reading must be entered.

The following example shows the effect of different *PEAK EXCURSION* settings.

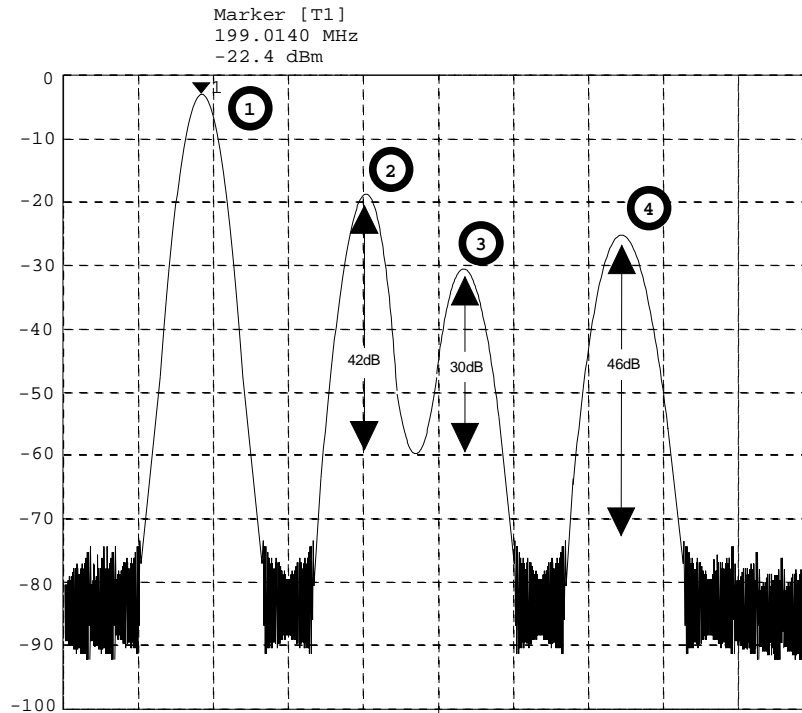

Fig. 4-7 Example for level measurements at various peak excursion settings

Maximum relative level change of the measured signals:

- Signal 2: 42dB
- Signal 3: 30dB
- Signal 4: 46dB

With **Peak Excursion 40dB** signals 2 and 4 are detected by *NEXT PEAK* or *NEXT PEAK RIGHT*. Signal 3 is not detected since it is only decreased by 30 dB before rising again.

Order in which signals are found:

- | | | | | |
|------------|----------|----|------------------|----------|
| PEAK: | Signal 1 | or | PEAK: | Signal 1 |
| NEXT PEAK: | Signal 2 | | NEXT PEAK RIGHT: | Signal 2 |
| NEXT PEAK: | Signal 4 | | NEXT PEAK RIGHT: | Signal 4 |

With **Peak Excursion 20dB** signal 3 is detected as well since its highest level change of 30 dB is now higher than the peak excursion.

Order in which signals are found:

- | | | | | |
|------------|----------|----|------------------|----------|
| PEAK: | Signal 1 | or | PEAK: | Signal 1 |
| NEXT PEAK: | Signal 2 | | NEXT PEAK RIGHT: | Signal 2 |
| NEXT PEAK: | Signal 4 | | NEXT PEAK RIGHT: | Signal 3 |
| NEXT PEAK: | Signal 3 | | NEXT PEAK RIGHT: | Signal 4 |

Whith **Peak Excursion 6dB** all signals are detected, *NEXT PEAK RIGHT* does not produce the required results.

Order in which signals are found:

PEAK: Signal 1
 NEXT PEAK: Signal 2
 NEXT PEAK: Signal 4
 NEXT PEAK: Signal 3

or

PEAK: Signal 1
 NEXT PEAK RIGHT: Marker in noise between signal 1 and signal 2
 NEXT PEAK RIGHT: Marker in noise between signal 1 and signal 2



The *SEARCH LIMIT ON/OFF* softkey switches between a limited (*ON*) and unlimited (*OFF*) search range.

For peak and min. search functions, the search range can also be limited by the frequency and time lines (*FREQUENCY LINE 1, 2/TIME LINE 1, 2*). If *SEARCH LIMIT = ON*, the appropriate signal level will only be searched for between the specified frequency/time lines.

The default setting is *SEARCH LIMIT = OFF*.

When only one line is enabled, frequency/time line 1 is defined as the lower limit and the upper limit is defined by the stop frequency. If frequency/time line 2 turned on, then it determines the upper limit.

For the case in which no line is active the search range is unlimited.

IEC/IEEE-bus command

```
:CALCulate<1|2>:MARKer<1..4>:X:SLIMits ON|OFF
```

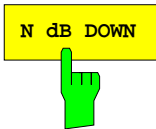

The *N dB DOWN* softkey automatically activates the temporary markers T1 and T2 and sets them n dB below the active reference marker. Marker T1 is located on the left, the marker T2 is located on the right of the reference marker. The value n can be entered in an entry window. The default value is 6 dB.

The frequency difference between the two temporary markers is indicated in the level output field.

If, e.g., due to the noise level, it is not possible to determine the frequency difference for the n dB value, dashes are displayed instead of the measured value.

Entry mode is switched to the reference marker for the case in which the delta maker entry mode is to be active. The position of the reference marker can be changed in the usual way (numeric input, step-keys, roll-key, peak search, etc.).

Pressing the *N dB DOWN* softkey again switches the function off, however, the entry function for the reference marker remains turned on.

IEC/IEEE-bus commands

```
:CALCulate<1|2>:MARKer<1..4>:FUNction:NDBDown 3DB  

:CALCulate<1|2>:MARKer<1..4>:FUNction:NDBDown:STATe ON  

:CALCulate<1|2>:MARKer<1..4>:FUNction:NDBDown:RESult?  

:CALCulate<1|2>:MARKer<1..4>:FUNction:NDBDown:FREQ?
```

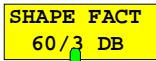

The *SHAPE FACT 60/3dB* and *SHAPE FACT 60/6dB* softkeys activate the automatic measurement of the form factor for the displayed signals.

For this purpose, four temporary markers are used. The markers T1 to T4 indicate, in increasing order, the 3 dB/6 dB positions below the reference marker level.

In the level output field, the relationship between the two frequency differences $\Delta f_{60dB} / \Delta f_{3dB}$ and $\Delta f_{60dB} / \Delta f_{6dB}$ are displayed

The display of the measurement value takes place in the marker field. When the level differences cannot be determined, the measurement value is marked as invalid. The update of the shape-factor display takes place at the end of sweep.

The entry mode is switched to the reference marker if the delta marker entry mode is to be active. The position of the reference marker can be changed in the usual way (numeric input, step-keys, roll-key, peak search, etc.).

The *SHAPE FACTOR* function is turned off by pressing *SHAPE FACTOR* softkey once again, or by enabling another marker.

The *SHAPE FACTOR* function is available only in the frequency domain.

IEC/IEEE-bus commands

```
:CALCulate<1|2>:MARKer<1..4>:FUNction:SFActor
      (60dB/3dB) | (60dB/6dB)
:CALCulate<1|2>:MARKer<1..4>:FUNction:SFActor:STATe ON
:CALCulate<1|2>:MARKer<1..4>:FUNction:SFActor:RESult?
:CALCulate<1|2>:MARKer<1..4>:FUNction:SFActor:FREQ?
```

Summary Marker

The summary markers are available for measurements in the time domain (SPAN = 0).

Unlike the markers and delta markers, the *summary markers* are not used to mark the pixels of a trace. They activate a measurement of the rms value (*RMS*) or of the average value (*MEAN*) of the whole trace. The result is displayed in the marker info field.

The measured values are either updated after every sweep or averaged according to a defined number of sweeps (*AVERAGE ON/OFF* and *SWEEP COUNT*). In case of maximum peak evaluation (*PEAK HOLD ON*) the measured values are held until the occurrence of the next higher value.

Example:

Marker info field switched on with summary marker: *MEAN*, *AVERAGE ON* and *PEAK HOLD ON*

```
MEAN HOLD      2.33 Watt
MEAN AV        2.29 Watt
```

The evaluation range can be limited with the function *SEARCH LIMITS ON* and the time lines (*TIME LINE1,2*), eg when measuring the average power of a sampled signal from the beginning to the end of a burst.

With the summary marker switched on, the sampling detector is activated (*TRACE-DETECTOR-AUTO*).

MARKER SEARCH menu

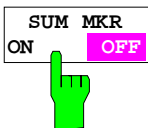

The *SUM MKR* softkey activates the summary marker

The measurement, rms or average value and the settings for maximum peak evaluation and averaging is selected in the submenu *SUMMARY MARKER*.

The softkey is only available in the time domain.

IEC/IEEE-bus command

```
:CALCulate<1|2>:MARKer<1..4>:FUNction:SUMMary ON|OFF
```

MARKER SEARCH menu

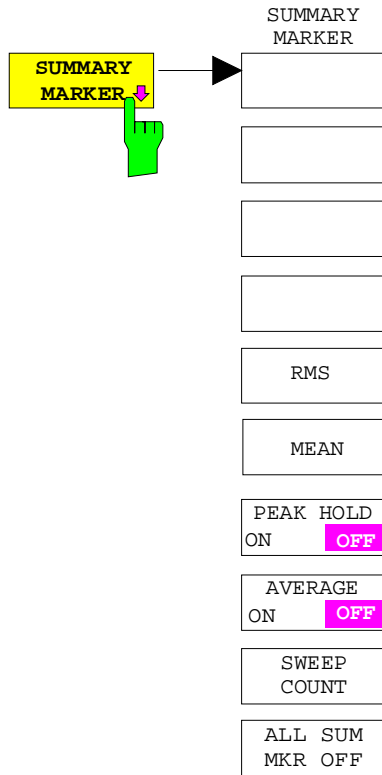

The *SUMMARY MARKER* softkey calls up the submenu for selecting the summary marker measurements.
 The softkey is only available in the time domain.

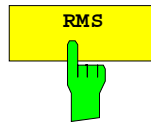

The *RMS* softkey selects the measurement of the rms value of the signal per sweep.

In case of maximum peak evaluation the highest rms value since the activation of *PEAK HOLD ON* is displayed. In case of *AVERAGE ON* the rms values of a trace are averaged and displayed over several sweeps.

The number of sweeps is set with the *SWEEP COUNT* softkey. If *PEAK HOLD = ON* is active at the same time, the display is held until the occurrence of the next higher average value.

IEC/IEEE-bus commands

```
:CALCulate<1 | 2>:MARKer<1..4>:FUNCTION:SUMM:RMS ON
:CALCulate<1 | 2>:MARKer<1..4>:FUNCTION:SUMM:RMS:RES?
:CALCulate<1 | 2>:MARKer<1..4>:FUNCTION:SUMM:RMS:AVER:RES?
:CALCulate<1 | 2>:MARKer<1..4>:FUNCTION:SUMM:RMS:PHOL:RES?
```

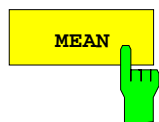

The *MEAN* softkey selects the measurement of the average value of the signal per sweep.

Thus, the mean power can be measured, for example during a GSM burst.

In case of maximum peak evaluation, the highest average value since the activation of *PEAK HOLD ON* is displayed.

In case of *AVERAGE ON*, the average values of a trace are averaged and displayed over several sweeps.

The number of sweeps is set with the *SWEEP COUNT* softkey. If *PEAK HOLD = ON* is active at the same time, the display is held until the occurrence of the next higher average value.

IEC/IEEE-bus commands

```
:CALCulate<1 | 2>:MARKer<1..4>:FUNCTION:SUMM:MEAN ON
:CALCulate<1 | 2>:MARKer<1..4>:FUNCTION:SUMM:MEAN:RES?
:CALCulate<1 | 2>:MARKer<1..4>:FUNCTION:SUMM:MEAN:AVER:RES?
:CALCulate<1 | 2>:MARKer<1..4>:FUNCTION:SUMM:MEAN:PHOL:RES?
```

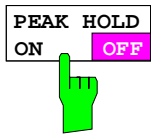

The *PEAK HOLD ON/OFF* softkey switches the maximum peak evaluation on and off.

For all active summary markers, the displays are updated after each sweep only if higher values have occurred.

The measured values can be reset by switching the *PEAK HOLD ON / OFF* softkey on and off again.

IEC/IEEE-bus command

:CALCulate<1|2>:MARKer<1..4>:FUNCTION:SUMMARY:PHOLD ON

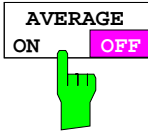

The *AVERAGE ON/OFF* softkey switches the averaging of the summary markers on and off.

The measured values can be reset by switching the *AVERAGE HOLD ON / OFF* softkey on and off again.

IEC/IEEE-bus command

:CALCulate<1|2>:MARKer<1..4>:FUNCTION:SUMMARY:AVERAGE ON



The *SWEEP COUNT* softkey activates the entry of the number of sweeps in the *SINGLE SWEEP* mode.

The permissible range of values is 0 to 32767.

In case of *AVERAGE ON*:

If an averaging has been selected, *SWEEP COUNT* also determines the number of measurements required for averaging.

SWEEP COUNT = 0 10 measured values are required for running averaging.

SWEEP COUNT = 1 No averaging is carried out.

SWEEP COUNT > 1 An averaging is carried out over the set number of measured values.

In the *CONTINUOUS SWEEP* mode averaging is performed until the number of sweeps set under *SWEEP COUNT* is attained and then running averaging is performed.

The maximum peak evaluation is infinite independent of the entry under *SWEEP COUNT*.

Note: This setting is equivalent to the settings of the number of sweeps of menus *TRACE* and *SWEEP-SWEEP*.

IEC/IEEE-bus command :[SENSe<1|2>:]SWEep:COUNT 20



The *ALL SUM MKR OFF* softkey switches all the summary markers off.

IEC/IEEE-bus command

:CALCulate<1|2>:MARKer<1..4>:FUNCTION:SUMMARY:AOFF

Instrument Parameter Changes via Markers – MKR → Key

MARKER MKR →menu:

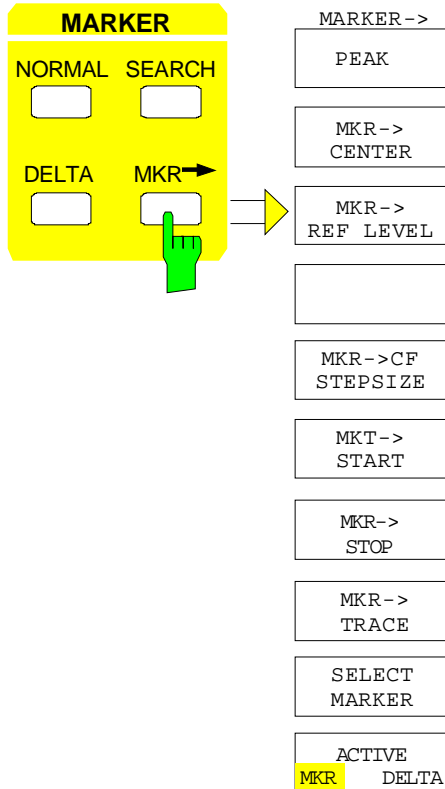

The *MKR →* menu offers functions that can be used to change instrument settings with the currently active marker. Exactly as in the *SEARCH* menu, these functions can also be applied to the delta markers.

The choice between marker and delta marker is made according to the currently active frequency entry mode for the marker/delta marker. If no entry mode is active, the marker with the lowest number will be activated as the reference marker.



The *ACTIVE MKR /DELTA* softkey toggles between the active marker and the active delta marker.

If *DELTA* is illuminated, the following marker functions are carried out with the active delta marker.

Note: *Switching between marker and delta marker can also be done with the NORMAL and DELTA keys.*

IEC/IEEE-bus command --



To simplify control, the *PEAK* search function (see section "Search Functions - *SEARCH* Key") is also available in the *MRK →* menu. Thus, the most important functions *MARKER →PEAK*, *MKR →CENTER* and *MKR →REF LEVEL* can be selected in one menu.

IEC/IEEE-bus commands

```
:CALCulate<1 | 2>:MARKer<1..4>:MAX
:CALCulate<1 | 2>:DELTamarker<1..4>:MAX
```

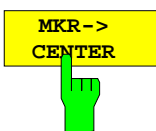

The *MKR →CENTER* softkey sets the center frequency to the current marker/delta marker frequency .

The softkey is not available in the time domain.

IEC/IEEE-bus command

```
:CALCulate<1 | 2>:MARKer<1..4>:FUNctio:n:CENTer
```

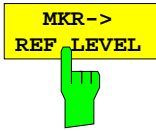

The *MKR→REF LEVEL* softkey sets the reference level to that of the current marker.

IEC/IEEE-bus command
 :CALCulate<1|2>:MARKer<1..4>:FUNction:REFerence



The *MKR→CF STEPSIZE* softkey sets the step size for the center frequency variation to the current marker frequency, and also sets step-size adaptation to *MANUAL*. The *CF STEP SIZE* remains at this value until the center frequency entry mode in the STEP menu is switched from *MANUAL* to *AUTO* again.

The *MKR→CF STEPSIZE* function is, above all, useful when measuring harmonics with a large dynamic range (small bandwidth and small span).

The softkey is not available in the time domain.

IEC/IEEE-bus command
 :CALCulate<1|2>:MARKer<1..4>:FUNction:CSTep



The *MKR→START* softkey sets the start frequency to the current marker frequency.

The softkey is not available in the time domain.

IEC/IEEE-bus command
 :CALCulate<1|2>:MARKer<1..4>:FUNction:START



The *MKR→STOP* softkey sets the stop frequency to the current marker frequency.

The softkey is not available in the time domain.

IEC/IEEE-bus command
 :CALCulate<1|2>:MARKer<1..4>:FUNction:STOP

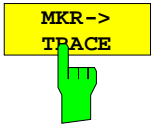

The *MKR→TRACE* softkey places the active marker on a new trace. The traces available for selection appear in the selection window.

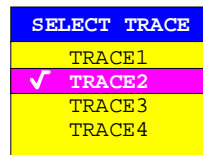

IEC/IEEE-bus commands
 :CALCulate<1|2>:MARKer<1..4>:TRACe 2
 :CALCulate<1|2>:DELTamarker<1..4>:TRACe 2

Setup of Display and Limit Lines – *LINES* Key Field

Display Lines – *D LINES* Key

Display lines are aids which, similar to markers, make the evaluation of trace data more convenient. The function of display lines is similar to that of a movable scale which can be used to measure absolute and differential values on traces.

In addition, the display lines can also be used to limit the range of search for marker functions.

The FSE provides four different types of display lines:

- two horizontal threshold lines for setting levels or for defining level search ranges – Display Line 1/2,
- two vertical frequency/time lines for indicating frequencies/times or for determining frequency or time search ranges – Frequency/Time Line 1/2,
- a threshold line which, for example, sets the search threshold for maximum levels (Peak Search) – Threshold Line
- a reference line which serves as the basis for mathematical correlation between traces – Reference Line

For purposes of clarity, each line is annotated on the right side of the display diagram by the following abbreviations:

| | | | |
|----|------------------|-----|----------------|
| D1 | Display Line 1 | T1 | Time Line 1 |
| D2 | Display Line 2 | T2 | Time Line 2 |
| F1 | Frequency Line 1 | TH | Threshold Line |
| F2 | Frequency Line 2 | REF | Reference Line |

The lines for level, threshold and reference are displayed as continuous, horizontal lines over the full width of the diagram. They are movable in the y-direction.

The lines for frequency and time are displayed as vertical, continuous lines over the total height of the diagram. They are movable in the x-direction.

For measurement operations in two separate windows, (Split Screen-Modus), the display lines are available independently in both windows. In the currently active window, the display lines can be activated and/or shifted. Lines previously defined in the currently inactive window remain unchanged.

The *LINES-D LINES* menu, used for switching on and setting the display lines, is dedicated to the chosen display in the active measurement window (span or time). For the display of a spectrum (span \neq 0), the *FREQUENCY LINE 1* and *FREQUENCY LINE 2* softkeys appear, For the time display (span = 0), the *TIME LINE 1* and *TIME LINE 2* softkeys are displayed.

Note: The softkeys for setting and switching the display lines on and off operate similar to a three-position switch:

Initial condition: The line is switched off (softkey has grey background)

1st press: The line is switched on (softkey has red background) and data entry is activated. The position of the display line can be adjusted by using the roll-key, the step keys or through direct numerical inputs via the data-entry keypad. If some other arbitrary function is requested, the data-entry keypad is disabled. In this case, the display line remains switched on (softkey has green background).

2nd press: The display line is switched off (softkey has grey background).

Initial condition: The line is switched on (softkey has green background)

1st press: The line is switched on (softkey has red background) and data entry is activated. The position of the display line can be adjusted by using the roll-key, the step keys or through direct numerical inputs via the data-entry keypad. If any other arbitrary function is requested, the data-entry keypad is disabled. In this case, the display line remains switched on (softkey has green background).

2nd press: The display line is switched off (softkey has grey background).

Menu *LINES-D-LINES*

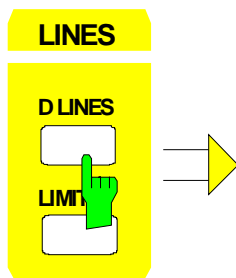

for Span \neq 0

| |
|-------------------|
| DISPLAY LINES |
| DISPLAY LINE 1 |
| DISPLAY LINE 2 |
| THRESHOLD LINE |
| REFERENCE LINE |
| |
| FREQUENCY LINE 1 |
| FREQUENCY LINE 2 |
| |
| BASELINE CLIPPING |
| |

for Span = 0

| |
|-------------------|
| DISPLAY LINES |
| DISPLAY LINE 1 |
| DISPLAY LINE 2 |
| THRESHOLD LINE |
| REFERENCE LINE |
| |
| TIME LINE 1 |
| TIME LINE 2 |
| |
| BASELINE CLIPPING |
| |

or:

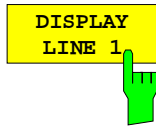

The *DISPLAY LINE 1/2* softkeys switch the display lines on/off and activate the entry of the line location.

The display lines mark the selected levels in the measurement window.

IEC/IEEE-bus commands

```
:CALCulate<1|2>:DLINe<1|2>:STATe ON | OFF;
:CALCulate<1|2>:DLINe<1|2> -20dBm
```

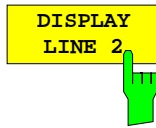

The *THRESHOLD LINE* softkey switches the threshold line on/off and activates the entry of the line location.

The threshold line is a display line which defines a threshold value. This threshold value serves as a lower search limit for maximums/minimums in the marker functions (*MAX PEAK*, *MIN PEAK*, *NEXT PEAK* etc.). For signal tracking (*SIGNAL TRACK function*), this threshold value defines the lower search limit (see section "Marker Functions").

IEC/IEEE-bus commands

```
:CALCulate<1|2>:THReshold ON | OFF;
:CALCulate<1|2>:THReshold -82dBm
```

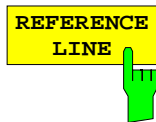

The *REFERENCE LINE* softkey switches the reference line on/off and activates the entry of the line position.

The reference line serves as the basis for mathematical correlation between trace data (see section "Mathematical Operations on Measurement Curves")

IEC/IEEE-bus commands

```
:CALCulate<1|2>:RLINe:STATe ON | OFF;
:CALCulate<1|2>:RLINe -10dBm
```

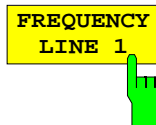

The *FREQUENCY LINE 1/2* softkeys switch the frequency lines 1/2 on/off and activate the entry of the line locations.

The frequency lines mark the selected frequencies in the measurement window or define search ranges (see section "Marker Functions").

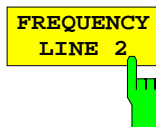

IEC/IEEE-bus commands

```
:CALCulate<1|2>:FLINe<1|2>:STATe ON | OFF;
:CALCulate<1|2>:FLINe<1|2> 120 MHz
```

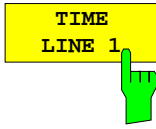

The *TIME LINE 1/2* softkeys switch the time lines 1/2 on/off and activate the entry of line locations.

The time lines mark the selected times or define the search range (see section "Marker Functions").

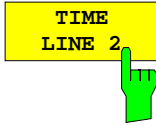

IEC/IEEE-bus commands

```
:CALCulate<1|2>:TLINe<1|2>:STATe ON | OFF;
:CALCulate<1|2>:TLINe<1|2> 10ms
```



The *BASELINE CLIPPING* softkey switches on or off the *BASELINE CLIPPING* function and allows a limit value to be entered.

The *BASELINE CLIPPING* function is for blanking measured values (for example noise) which are below a preset threshold.

If the *BASELINE CLIPPING* function is active and a measured value is below the preset threshold, the value is set to a lower boundary (-400 dBm). Measured values above the clipping level are not changed.

Note: *It is advisable not to combine the BASELINE CLIPPING function with the AUTOPEAK detector.*

If the set clipping value is within the displayed noise band (AUTOPEAK detector), activation of the CLIPPING function and the resulting clipping of the MIN PEAK values will lead to a drastic enlargement of the displayed noise band.

IEC/IEEE-bus commands

```
:CALCulate<1|2>:CTHreshold:STATe ON | OFF
:CALCulate<1|2>:CTHreshold -82dBm
```

Limit Lines – *LIMITS* Key

Limit lines are used to define limits for amplitude curves or spectral distributions on the screen. They indicate, for example, the upper limits for interference radiation or spurious waves which are permissible from a Unit Under Test (UUT). In the case of TDMA transmissions (e.g., GSM), the amplitude curve of the bursts in a time slot must fall within a specified tolerance band. The lower and upper limits may each be specified by a limit line. Then, the amplitude curve can be checked either visually or automatically for any violations of the upper or lower limits (GO/NOGO test).

The FSE instrument supports up to 300 limit lines, each of which may have a maximum of 50 data points. For each limit line, the following characteristics must be defined:

- The name of the limit line. The limit line is stored under this name and is displayed in the *LIMIT LINES* table.
- The domain in which the limit line is to be used. A distinction is made between the time domain (span = 0 Hz) and the frequency domain (span > 0 Hz).
- The X-coordinates of the interpolation points. The limit line can be specified either in terms of absolute frequencies or times or in terms of frequencies referred to the set center frequency and times referred to the time represented by the left-hand edge of the diagram.
- The Y-coordinates of the interpolation points. The limit line can be selected either for absolute levels or voltages or referred to the set maximum level (Ref Lvl or Max Lvl). If the reference line is switched on, it is used as reference when relative setting has been selected.
- The type of limit line (upper or lower limit). With this definition and the limit checking function on (*LIMIT CHECK*), the FSE checks for compliance with each limit.
- The limit line units. The units for the limit line must be compatible with the level axis in the active measurement window.
- The trace to which the limit line is assigned. For the FSE, this defines the trace to which the limit is to be applied when several traces are simultaneously displayed.
- For each limit line, a margin can be defined which serves as a threshold for automatic evaluation.
- A comment can also be entered for each limit line, e.g., a description of the application.

In the *LINES LIMIT* menu, the compatible limit lines can be enabled in the *LIMIT LINES* table. The *SELECTED LIMIT LINE* display field provides information about the characteristics of the marked limit lines. New limit lines can be specified and edited in the *NEW LIMIT LINE* and *EDIT LIMIT LINE* sub-menus.

LINES LIMIT menu

Limit Line Selection

The *SELECTED LIMIT LINES* table provides information about the characteristics of the marked limit line :

| | |
|------------------|--|
| <i>Name</i> | name |
| <i>Domain</i> | frequency or time |
| <i>Limit</i> | upper/lower limit |
| <i>X-Axis</i> | linear or logarithmic interpolation |
| <i>X-Scaling</i> | absolute or relative frequencies/times |
| <i>Y-Scaling</i> | absolute or relative Y-units |
| <i>Unit</i> | for vertical scale |
| <i>Comment</i> | comment |

The characteristics of the limit line are set in the *EDIT LIMIT LINE (=NEW LIMIT LINE)* submenu.



The *SELECT LIMIT LINE* softkey activates the *LIMIT LINES* table and the selection bar jumps to the uppermost name in the table.

The columns headings are as follows:

| | |
|--------------------|---|
| <i>Name</i> | NAME of the limit line to be selected. |
| <i>Compatible</i> | Indicates if the limit line is compatible with the measurement window of the given trace. |
| <i>Limit Check</i> | Activates the automatic "within limits" check. |
| <i>Trace</i> | Selects the trace to which the limit is assigned. |
| <i>Margin</i> | Defines a margin. |

Name and Compatible - Switching on limit lines

A maximum of 8 limit lines can be switched at any one time. A check mark at the left edge of a cell indicates that this limit line is switched on. A limit line can only be switched on when it has a check mark in the *Compatible* column, i.e., only when the display mode of the x-axis (time or frequency) and y-axis units are **identical** to those in the measurement window.

It should be noted that lines with dB scales are compatible with all dB(..) scales of the Y-axis.

If the trace assigned to a line is not switched on, the line is displayed in the window the trace would be displayed in.

Example:

In split screen mode, trace 2 is assigned measuring window B. A line assigned to trace 2 is always displayed in measurement window B.

If the y-axis unit or the domain (frequency or time) are changed, all non-compatible limit lines are automatically switched off in order to avoid misinterpretations. The limit lines must be switched on again when the original display mode is restored.

IEC/IEEE-bus commands

```
:CALCulate<1|2>:LIMit<1..8>:NAME <string>;
:CALCulate<1|2>:LIMit<1..8>:STATE ON | OFF
```

Limit Check - Activating the limit check

When *LIMIT CHECK ON* is activated, a limit check is performed automatically on the active screen. In the center of the screen, a display window containing the results of the limit check test appears:

LIMIT CHECK: PASSED No out-of-limits conditions.

LIMIT CHECK: FAILED One or more out-of-limits conditions. The message contains the names of the limit lines which were violated or whose margins were not complied with.

LIMIT CHECK: MARGIN The margin of at least one active limit line was not complied with, however, no limit line was violated. The message contains the names of the limit lines whose margins were not complied with.

The following example shows three active limit lines:

```
LIMIT CHECK: FAILED
LINE VHF_MASK: Failed
LINE UHF2MASK: Margin
```

A limit check is performed only if the trace associated with the limit line is turned on.

If *LIM CHECK* is set to *OFF* for all active limit lines, then the limit line check is not executed and the display field not activated.

IEC/IEEE-bus command :CALCulate<1|2>:LIMit<1...8>:FAIL?

Trace - Selecting the trace to which the limit line is assigned.

The trace is selected in an entry window. An integer entries 1, 2, 3 or 4 indicating the trace is entered. The default setting is trace 1. If the selected limit line is not compatible with the assigned trace, the limit line is disabled. (display and limit check).

IEC/IEEE-bus command
`:CALCulate<1|2>:LIMit<1...8>:TRACe 1|2|3|4`

Margin - Setting a margin.

The margin is defined as the level difference between the limit line and the signal. When the limit line is defined as an upper limit, the margin means that the level is below the limit line. When the limit line is defined as a lower limit, the margin means that the level is above the limit line. The default setting is 0 dB (i.e., no margin).

IEC/IEEE-bus commands
`:CALCulate<1|2>:LIMit<1..8>:UPPer:MARGin 10DB`
`:CALCulate<1|2>:LIMit<1..8>:LOWer:MARGin 10DB`

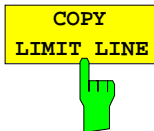

The *COPY LIMIT LINE* softkey copies the data set of the marked limit line and saves it under a new name. In this way, a new limit line can be easily generated by parallel translation or editing of an existing limit line. The name can be arbitrarily chosen and input via an entry window (max. of 8 characters).

IEC/IEEE-bus command
`:CALCulate<1|2>:LIMit<1..8>:COPY 1..8|<name>`



The *DELETE LIMIT LINE* softkey erases the selected limit line. Before deletion, a message appears requesting confirmation.

IEC/IEEE-bus command
`:CALCulate<1|2>:LIMit<1...8>:DELeTe`

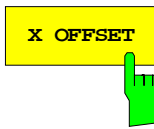

The *X OFFSET* softkey horizontally shift a limit lines which has been specified for relative frequencies or times (X-axis). The softkey opens an entry window, where the value for shifting may be entered numerically or via the roll-key.

Note: *When changing the start or the stop frequency, the line on the display only remains unchanged, if SPAN FIXED is set.*

IEC/IEEE-bus command
`:CALCulate<1|2>:LIMit<1..8>:CONT:OFFSet 100us`



The *Y OFFSET* softkey vertically shifts a limit line, which has relative values for the Y-axis (levels or linear units such as volt). The softkey opens an entry window where the value for shifting may be entered numerically or via the roll-key.

IEC/IEEE-bus commands
`:CALCulate<1|2>:LIMit<1..8>:UPP:OFFSet 3dB`
`:CALCulate<1|2>:LIMit<1..8>:LOW:OFFSet 3dB`

Entering and Editing of Limit Lines

A limit line is characterized by

- its name
- the domain assignment (frequency or time)
- whether the scale is absolute or relative (time or frequency)
- linear or logarithmic interpolation
- the vertical unit
- the vertical scale
- the definition of the limit line as either an upper or lower limit.
- the interpolation points for frequency/time and level

When the limit line is entered, the FSE immediately checks all limit lines according to rules that guarantee correct operation.

- The frequencies/times for each interpolation point must be entered in ascending order, however, for any single frequency/time, two data points may be entered (vertical segment of a limit line).

The interpolation points are allocated in order of ascending frequency/time. Gaps are not allowed. If gaps are desired, two separate limit lines must be defined and then both enabled.

- The entered frequencies/times need not necessarily be capable of selection on the FSE. A limit line may also exceed the frequency or time display range. The minimum frequency for an interpolation point is -200 GHz, the maximum frequency is 200 GHz. For the time domain, negative times may also be entered. The range is -1000 s to +1000 s.
- The minimum/maximum value for a limit line is -200 dB/ +200 dB for the logarithmic scale or 10^{-20} / 10^{+20} or -99.9%/ + 999.9% for linear amplitude scales.

LINES LIMIT-EDIT LIMIT LINE menu

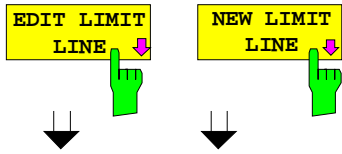

The *EDIT LIMIT LINE* and *NEW LIMIT LINE* softkeys both call the *EDIT LIMIT LINE* submenu used for editing limit lines. In the table heading, the characteristics of the limit line can be entered. The frequency/time and level points are entered in the columns.

- Name* Enter name.
- Domain* Select domain.
- Unit* Select units.
- X-Axis* Select interpolation
- X-Scaling* Entry of absolute or relative values for the X-axis
- Y-Scaling* Entry of absolute or relative values for the Y-axis
- Limit* Select upper/lower limit.
- Comment* Enter comments.
- Time/Frequency* Enter time/frequency points.
- Limit/dBm* Enter level points.

| EDIT LIMIT LINE TABLE | |
|-----------------------|--------------|
| Name: | Limit 22 |
| Domain: | FREQUENCY |
| Unit: | dBuV/m |
| X-Axis: | LOG |
| X-Scaling: | ABSOLUTE |
| Y-Scaling: | ABSOLUTE |
| Limit: | UPPER |
| Comment: | Limit 22 |
| FREQUENCY | LIMIT/dBuV/m |
| 30.000 MHz | 30.0000 |
| 230.000 MHz | 30.0000 |
| 230.000 MHz | 37.0000 |
| 1.000 GHz | 37.0000 |

Press ENTER to edit field.

EDIT
LIMIT LINE

NAME

VALUES

INSERT
VALUE

DELETE
VALUE

SHIFT X
LIMIT LINE

SHIFT Y
LIMIT LINE

SAVE
LIMIT LINE

PAGE UP

PAGE DOWN

↑

USER

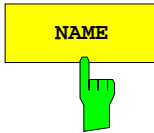

The *NAME* softkey activates the entry of characteristics in the table heading.

Name - Entry of name

A maximum of 8 characters are permitted for each name. All names must be compatible with the MS DOS conventions for file names. The instrument automatically stores all limit lines with the .LIM extension.

IEC/IEEE-bus command

```
:CALCulate<1|2>:LIMit<1..8>:NAME <string>
```

Domain - Selection of time or frequency domain

The domain (frequency/time) can only be changed when the limit-line point table is empty. The default setting is frequency.

IEC/IEEE-bus command

```
:CALCulate<1|2>:LIMit<1..8>:CONTRol:DOMain FREQ | TIME
```

X-Axis - Indication of interpolation

Linear or logarithmic interpolation can be carried out between the frequency reference points of the table. The ENTER key toggles between LIN and LOG selection.

IEC/IEEE-bus commands

```
:CALCulate<1|2>:LIMit<1..8>:CONTRol:SPACing LIN | LOG
:CALCulate<1|2>:LIMit<1..8>:UPPer:SPACing LIN | LOG
:CALCulate<1|2>:LIMit<1..8>:LOWer:SPACing LIN | LOG
```

Scaling - Selection of absolute or relative scale

The limit line scale can either be absolute (frequency or time) or relative. Any of the unit keys may be used to toggle between *ABSOLUTE* and *RELATIVE*, the cursor must in the *X-Scaling* or the *Y-Scaling* line

X-Scaling ABSOLUTE The frequencies or times are interpreted as absolute physical units.

X-Scaling RELATIVE The frequencies in the limit-line point table are referred to the currently set center frequency. In the time domain, the left boundary of the diagram constitutes the reference.

Y-Scaling ABSOLUTE The limit values are absolute levels or voltages.

Y-Scaling RELATIVE The limit values refer to the reference level or, in case a reference line is set, to the reference line. Limit values in dB or % are always relative values.

RELATIVE scaling is always recommended, if masks for bursts are to be defined in the time domain, or if masks for modulated signals are required in the frequency domain.

An X-offset equal to half the sweep time may be entered to shift the mask in the time domain to the center of the screen.

IEC/IEEE-bus commands

```
:CALCulate<1|2>:LIMit<1..8>:CONTRol:MODE REL | ABS
:CALCulate<1|2>:LIMit<1..8>:UPPer:MODE REL | ABS
:CALCulate<1|2>:LIMit<1..8>:LOWer:MODE REL | ABS
```

Unit - Selection of the vertical scale units for the limit line

Units are selected in a selection box. The default setting is dBm.



```
IEC/IEEE-bus command :CALCulate<1|2>:LIMit<1...8>:UNIT
                        DB| DBM| PCT |DBUV| DBMW | DBUA |
                        DBPW| DBPT | WATT| VOLT | AMPere |
                        DBUV_MHZ | DBMV_MHZ | DBUA_MHZ |
                        DBUV_M | DBUV_MMHZ | DBUA_M |
                        DBUA_MMHZ
```

Limit - Selection of upper/lower limit

A limit line can be defined as either an upper or lower limit.

```
IEC/IEEE-bus command --
(defined by the key words :UPPer or :LOWer)
```

Comment - Enter comments

Comments are user selectable, but may not exceed 40 characters in length.

```
IEC/IEEE-bus command
:CALCulate<1|2>:LIMit<1..8>:COMMENT 'string'
```

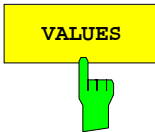

The *VALUES* softkey activates the entry of the data points in the table columns *Time/Frequency* and *Limit/dB*. Which table column appears depends on the *Domain* selection in the table heading.

The frequency/time points are entered in ascending order (two repeated frequencies/times are permitted).

```
IEC/IEEE-bus commands
:CALCulate<1|2>:LIMit<1...8>:CONTRol[:DATA]
<num_value>, <num_value>..
:CALCulate<1|2>:LIMit<1...8>:UPPer[:DATA]
<num_value>, <num_value>..
:CALCulate<1|2>:LIMit<1...8>:LOWer[:DATA]
<num_value>, <num_value>..
```

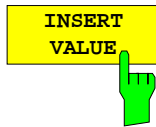

The *INSERT VALUE* softkey creates an empty line above the current cursor position where a new data point can be entered. However, when entering new values, the ascending order for frequency/time values must be kept.

IEC/IEEE-bus command --

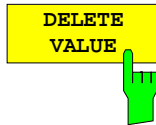

The *DELETE VALUE* softkey erases the data point (complete line) at the cursor position. The data points that follow are moved along to fill the gap.

IEC/IEEE-bus command --

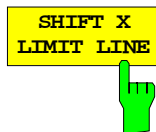

The *SHIFT X LIMIT LINE* softkey calls an entry window where the complete limit line may be shifted horizontally.

The shift units are the same as the horizontal scale units:

- in the frequency domain in Hz, kHz, MHz or GHz
- in the time domain in ns, μ s, ms or s

This means that it is easy to create a new limit line from existing limit line which has been shifted horizontally and stored (*SAVE LIMIT LINE* softkey) under a new name (*NAME* softkey).

IEC/IEEE-bus command

```
:CALCulate<1|2>:LIMit<1..8>:CONTRol:SHIFt 50kHz
```



The *SHIFT Y LIMIT LINE* softkey calls an entry window where the complete limit line may be shifted vertically.

The shift units are the same as the vertical scale units:

- for relative logarithmic units in dB
- for linear units, as a factor

This means that a new limit line can easily be created from an existing limit line which has been shifted vertically and stored (*SAVE LIMIT LINE* softkey) under a new name (*NAME* softkey).

IEC/IEEE-bus commands

```
:CALCulate<1|2>:LIMit<1..8>:UPPer:SHIFt 20dB
```

```
:CALCulate<1|2>:LIMit<1..8>:LOWer:SHIFt 20dB
```

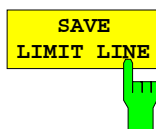

The *SAVE LIMIT LINE* softkey stores the currently edited limit line. The name can be entered in an entry window (max. 8 characters)

IEC/IEEE-bus command -- (automatically executed)

Trace Selection and Setup –TRACE Key Group

The FSE can display up to four separate traces at a time on a screen. A trace has of a maximum of 500 pixels along the horizontal axis (frequency or time). If more measured values than pixels are available, several measurement values are assigned to one pixel.

The traces are selected using keys 1 to 4 of the *TRACES* key group. When two measurement windows (*SPLIT SCREEN*) are displayed, traces 1 and 3 are assigned to the upper (*SCREEN A*) and traces 2 and 4 are assigned to the lower (*SCREEN B*) measurement window.

The traces can be individually activated for a measurement or frozen after completion of a measurement. Traces that are not activated are not displayed.

A display mode can be selected for each trace. The traces can be overwritten (*CLEAR/WRITE* mode) after each sweep, averaged (*AVERAGE* mode) over several sweeps, or the maximum/ minimum value from several sweeps can be displayed (*MIN HOLD/MAX HOLD*).

Individual detectors are selectable for each of the traces. The auto-peak detector displays the maximum and minimum values on a vertical line. The max-peak detector and min-peak detector display the maximum and /minimum levels represented by a pixel. The sampling detector displays the instantaneous value of the level at a pixel. The rms detector displays the power (rms) of the spectrum at a pixel, the average detector the average value.

Measurement Function Selection - TRACE 1 to 4 key

The trace functions are categorized as follows:

- type of trace display (*CLEAR/WRITE*, *VIEW* and *BLANK*)
- evaluation of the trace as a whole (*AVERAGE*, *MAX HOLD* and *MIN HOLD*)
- evaluation of the individual pixels of a trace (*AUTOPEAK*, *MAX PEAK*, *MIN PEAK*, *SAMPLE*, *RMS* and *AVERAGE*)

TRACE 1 menu

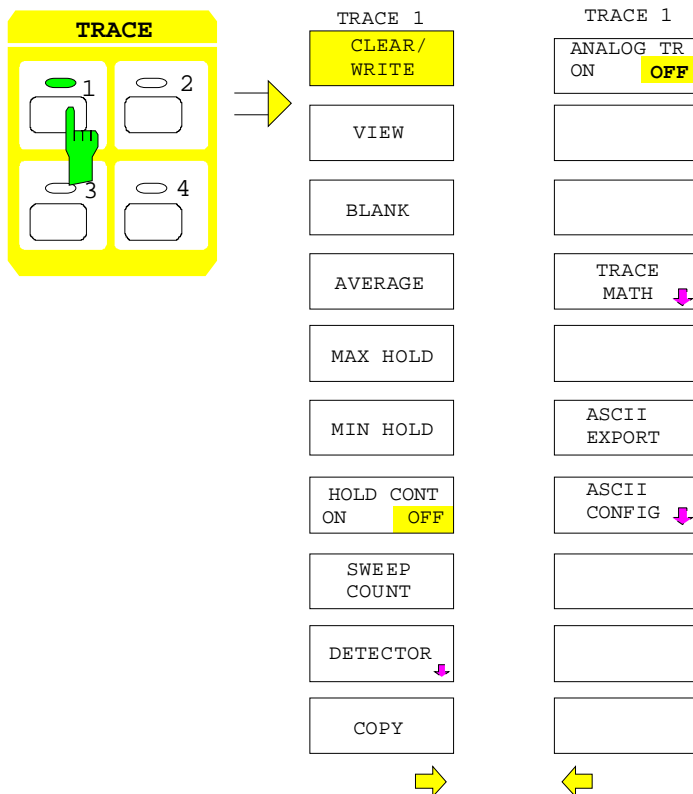

The *TRACE* keys 1...4 call a menu with the setting options for the selected trace.

This menu is used to determine the method for compressing the measurement data in the frequency or time domain to the 500 representable points of the display is determined.

When the measurement is started, a new trace can be displayed or the trace can be based on previous results. The traces can be displayed, blanked and copied.

Traces can also be corrected with the mathematical functions.

The measurement detector for each of the display types may be chosen either directly or selected automatically by the FSE.

All activated traces are marked with a LED at the corresponding key (here, *TRACE 1*). The default setting is *TRACE 1* with *CLEAR / WRITE* selected. The remaining traces 2...4 are switched off (*BLANK*). For the split screen display, the selection of the trace automatically selects the corresponding screen for entry.

Only one of the *CLEAR/WRITE*, *MAX HOLD*, *MIN HOLD*, *AVERAGE*, *VIEW* and *BLANK* softkeys can be activated at any one time.

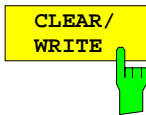

The *CLEAR/WRITE* softkey activates the clear/write display mode.

The trace is displayed without additional trace evaluation. The trace memory is overwritten by each sweep. If more than one data point falls within a pixel, the trace is displayed in bar form with the maximum and minimum values being assigned to one pixel. In the clear/write display mode, all the available detectors are selectable. The autopeak detector is selected in the default mode (detector to *AUTO*).

Whenever the *CLEAR/WRITE* softkey is pressed, the FSE clears the selected trace memory and restarts the measurement.

IEC/IEEE-bus command
`:DISPlay[:WINDow<1|2>]:TRACe<1..4>:MODE WRITE`

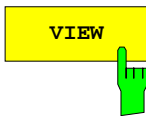

The *VIEW* softkey freezes the current contents of the trace memory and displays them.

If the trace data were formed through *MAX HOLD*, *MIN HOLD* or *AVERAGE*, the sweep is restarted and the trace contents are cleared, after switching to these trace modes.

If a trace is frozen by *VIEW*, the instrument settings can be modified without modifying the displayed trace. The fact that the trace and the current instrument setting do not agree anymore is indicated by an enhancement label "*" at the right edge of the grid. The initial instrument setting can be restored using the *ADJUST TO TRACE* softkey in the *TRACE MATH* sub-menu.

If *LEVEL RANGE* or *REF LEVEL* is changed in the *VIEW* display mode, the FSE adjusts the measurement data to the changed display range. Thus, an amplitude zoom can be performed after the measurement so that details of the trace can be seen better.

IEC/IEEE-bus command
`:DISPlay[:WINDow<1|2>]:TRACe<1..4>:MODE VIEW`

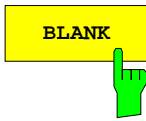

The *BLANK* softkey activates the blanking of the trace.

However, the trace remains stored in memory and can be displayed again by pressing *VIEW*. The markers for the blanked trace are also erased. After reactivation of the trace (with *VIEW*, *CLEAR / WRITE*, *MAX HOLD*, *MIN HOLD*, *AVERAGE*) the markers will be restored their their previous positions.

IEC/IEEE-bus command

```
:DISPlay[:WINDow<1|2>]:TRACe<1..4> OFF
```

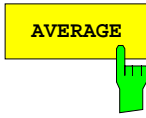

The *AVERAGE* softkey activates the trace averaging function. The average is formed over several sweeps. The average can be calculated for each available detector. If the detector is automatically selected by the FSE, the sampling detector is used.

After enabling the averaging mode, the first trace is recorded in *CLEAR/WRITE* mode with the selected detector. After the second sweep, the average is then formed for each succeeding sweep. Here, the average is formed over the samples/pixels, i.e., according to the *LIN* or *LOG* setting, over amplitudes or levels.

Averaging is restarted every time the *AVERAGE* softkey is pressed. The trace memory is also cleared. This is also the case when the trace is switched from the setting *AVERAGE* to *VIEW* or *BLANK*

IEC/IEEE-bus command

```
:DISPlay[:WINDow<1|2>]:TRACe<1..4>:MODE AVER
```

Description of averaging:

Averaging is carried out using the pixels which are derived from the measurement value samples. These pixels may in some cases be comprised of several combined measurement values. This means that the average is formed over linear amplitude values when the level display is linear and over levels when the level display is logarithmic. Because of this, the trace must be measured anew when changing between the *LIN* and *LOG* display mode. The settings *CONT/SINGLE SWEEP* and the sliding average apply to the average display analogously.

Two calculation procedures are available for averaging. For *SWEEP COUNT*= 0, a sliding average is calculated using the following equation:

$$\text{TRACE}_n = \frac{9 * \text{TRACE}_{n-1} + \text{Meas_Value}}{10}$$

Because of the relative weighting of the new measurement value and the trace average, past values have practically no influence on the displayed trace after about 10 sweeps. For this setting, the signal noise is effectively reduced without the need to restart the averaging process even if the signal is changed.

If the *SWEEP COUNT* is >1 averaging takes place over the selected number of sweeps. In this case, the displayed trace is given by the following formula during averaging::

$$\text{TRACE}_n = \frac{1}{n} \left[\sum_{i=1}^{n-1} (T_i) + \text{Meas Value} \right]$$

where n is the number of the current sweep (n = 2 ... *SWEEP COUNT*). For the first sweep, an average is not calculated. The measurement values are stored directly in trace memory. With growing n, the displayed trace becomes increasingly smoother since more individual trace data are available for averaging.

The average is stored in trace memory after the defined number of sweeps. Until this number of sweeps is reached, a preliminary average is displayed.

On completion of averaging, ie when the number of sweeps defined with *SWEEP COUNT* has been reached, a sliding average given by the following formula is obtained with *CONTINUOUS SWEEP*

$$TRACE_n = \frac{(N-1) \cdot TRACE_{n-1} + \text{Meas Value}}{N}, \text{ where}$$

Trace = new trace
Trace_{old} = old trace
N = SWEEP COUNT

The display "Sweep 200 of 200" then remains constant until there is a new start.

In *SINGLE SWEEP* mode, *SWEEP START* initiates n single sweeps. The sweeps are stopped as soon as the selected number of sweeps has been reached. The number of the current sweep and the total number of sweeps are shown in the display: "Sweep 3 of 200".



The *SWEEP COUNT* softkey activates the entry of the number of sweeps used for averaging.

The range for *SWEEP COUNT* is 0 through 32767. For 0, the FSE performs a sliding average over 10 sweeps. For 1, no averaging takes place.

The default setting is 10 sweeps. The programming naturally influences the sweep duration. The number of sweeps used for averaging is the same **for all 4 traces**.

Note : *The setting of the SWEEP COUNT in the trace menu is equivalent to the setting in the sweep menu.*

IEC/IEEE-bus command : [SENSE<1|2>:]SWEEP:COUNT 10

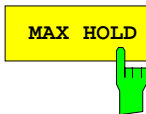

The *MAX HOLD* softkey activates the max hold mode.

In this display mode, the FSE saves for each sweep the largest of the previously stored/currently measured values in the trace memory. The detector is set automatically to *MAX PEAK*. In this way, the maximum value of a signal can be determined over several sweeps.

This is especially useful for measurement of modulated or pulsed signals. The signal spectrum is built up sweep by sweep until all the signal components have been captured.

Pressing of the *MAX HOLD* softkey again clears the trace memory and restarts the max hold mode.

If *MAX HOLD* is enabled, a new start is made after clearing the trace memory for each frequency change, (start frequency, stop frequency, center frequency or frequency span), a reference level change or switching between linear/logarithmic scales.

IEC/IEEE-bus command : DISPLAY[:WINDOW<1|2>]:TRACE<1..4>:MODE MAXH

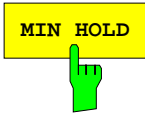

The *MIN HOLD* softkey activates the min hold mode. In this display mode, the FSE saves for each sweep the smallest of the previously stored/currently measured values in the trace memory. The detector is set automatically to *MIN PEAK*. In this way, the minimum value of a signal can be determined over several sweeps. This function is, e.g., useful for making an unmodulated carrier in a signals mixture easier to see on the display. Noise, interference or modulated signals are suppressed by the *MIN HOLD* function, whereas a CW signal maintains a constant level.

Pressing the *MIN HOLD* softkey clears the trace memory and the minimum value function starts anew.

IEC/IEEE-bus command
`:DISPlay[:WINDow<1|2>]:TRACe<1..4>:MODE MINH`

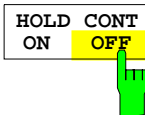

The *HOLD CONT* softkey defines whether the traces in the average mode and min hold/max hold mode are reset after some definite parameter changes.

OFF The traces are reset after some definite parameter changes.

ON This mechanism is switched off.

In general, parameter changes require a restart of the measurement before results are evaluated (e. g. with markers). For those changes that are known to require a new measurement (e. g. modification of the span), the trace is automatically reset so that erroneous evaluations of previous results are avoided.

This mechanism can be switched off for those exceptional cases where the described behavior is unwelcome.

IEC/IEEE-bus command
`:DISPlay[:WINDow<1|2>]:TRACe<1..4>:MODE HCON ON|OFF`

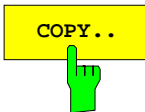

The *COPY* softkey copies the current trace as display on the screen to another trace memory. A table appears in which the copy procedure can be selected.

| COPY TRACE 1 TO | |
|-----------------|---------|
| ✓ | TRACE 2 |
| | TRACE 3 |
| | TRACE 4 |

For only one window, the selected trace can be copied to any of the other trace memories since here, all four traces are displayed in one diagram with the same frequency boundaries.

In the split screen display, this is only possible as long as the frequencies of screen A and screen B are identical. If this is not the case, the selected trace can only be copied to the corresponding trace memory, i.e., trace 1 to trace 3 and trace 2 to trace 4 or vice versa. In this case, only the available trace is displayed.

After copying, the contents of the destination memory are lost. The destination memory now changes automatically to view mode with the new data.

IEC/IEEE-bus command
`:TRACe:COPIY TRACE1 | TRACE2 | TRACE3 | TRACE4 ,
TRACE1 | TRACE2 | TRACE3 | TRACE4`

Detector Selection

The FSE detectors are all-digital. The detectors available are the max-peak detector which derives the maximum value from a number of sample values, the min-peak detector which derives the minimum value from a number of sample values and the sampling detector. The sampling detector passes on the sampled data without modification or performs a data reduction by suppressing non-displayable values. The peak detectors compare the current level with the maximum/minimum levels of the previously sampled data. When the number of samples defined by the instrument settings is reached, the samples are combined as displayable pixels. Each of the 500 pixels of the display therefore represents 1/500 of the sweep range and so all the individual measurements (frequency samples) that fall within this subrange in a compressed form. Even though the recording rate is high, there are no recording gaps thanks to the internal pipeline structure. For each trace display mode, an optimized detector is selected automatically. Since the peak detectors and the sample detector are connected in parallel, a single sweep is sufficient for record and display four traces with four detectors.

Peak value detectors (MAX PEAK / MIN PEAK)

Peak value detectors are implemented with digital comparators. For each of the levels measured at each of the frequencies represented by one of the 500 pixels, they determine the maximum (max peak) of all positive peaks and the minimum (min peak) of all the negative peaks. This is repeated for each pixel so that, for wide frequency spans and in spite of the limited display resolution, a larger number of measurements than would otherwise be possible can be used to display the spectrum.

AUTOPEAK detector

The *AUTOPEAK* detector combines the two peak detectors. The max-peak detector and min-peak detector determine the maximum and minimum level over a displayed pixel at the same time and display it as a common measurement value. The maximum and minimum level over a frequency point are joined with a vertical line.

SAMPLE detector

The *SAMPLE* detector passes on all sampled data without further evaluation and either displays them directly or, for speed (short sweep times), first writes them to a memory and subsequently processes them.

Data reduction, i.e., summing of measurement values of neighboring frequencies or time samples is not performed here. If, during a sweep, more measurement values are generated than can be displayed, measurement values will be lost. Discrete signals can thus be lost

Therefore, the sampling detector can only be recommended for a ratio of span-to-resolution bandwidth of up to approximately 250. To ensure that no signal will be suppressed (example: span 1 MHz --> min. bandwidth 5 kHz).

| | |
|------------------|--|
| RMS detector | <p>The rms detector finds the rms value of the measured values over a pixel.</p> <p>The FSE uses the linear display voltage after the envelope detection. The linear samples are squared, summed and the sum is divided through the number of samples (= mean of squares). With the logarithmic display, the logarithm of the sum of squares is taken. With the linear display the mean of the squares is displayed directly. Each pixel represents the total power of the measured values assigned to the pixel.</p> <p>The rms detector supplies the power of the signal irrespective of the waveform (CW carrier, modulated carrier, white noise or pulse signal). There is no need for the various waveform correction factors which are required when other detectors are used for the power measurement.</p> |
| Average detector | <p>The average detector averages the measured values over a pixel.</p> <p>The FSE uses the linear display voltage after envelope detection. The linear samples are summed and the sum is divided by the number of measurement samples (= linear average). With the logarithmic display, the logarithm of the average is taken. With the linear display the average is displayed directly. Each pixel therefore represents the average of the measured values assigned the pixel.</p> <p>The average detector gives the true average of the signal irrespective of the waveform (CW carrier, modulated carrier, white noise or pulse signal).</p> |

Notes: *During a sweep, the FSE switches the first oscillator frequency in steps which are smaller than approximately 1/10 of the bandwidth. This guarantees that the level of a signal is correctly measured. For narrow bandwidths and wide spans, a very large number of measurement values are generated. The number of frequency steps is, however, always a multiple of 500 (= number of displayable points). In the sampling mode, only every n^{th} value is displayed. The quantity n depends upon the number of measurement values, i.e on the span, resolution bandwidth and the measurement rate.*

For sweep times < 5ms in the time domain, the same detector is used for all active traces.

TRACE 1-DETECTOR submenu

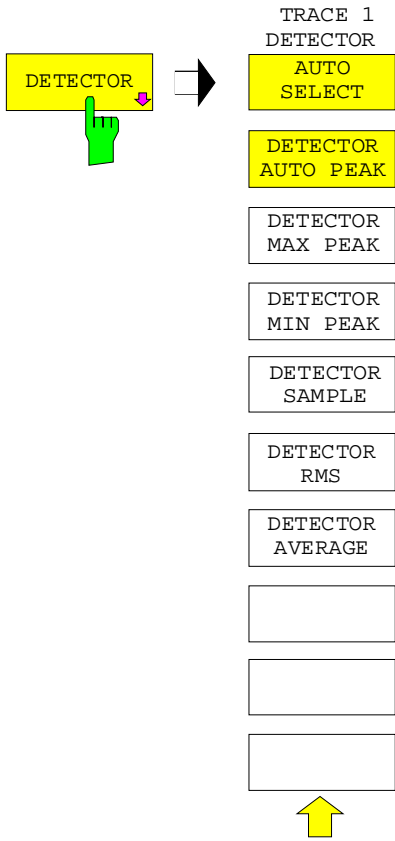

The *DETECTOR* softkey opens a submenu to select the detector.

The detector may be independently selected for each trace. Mode *AUTO SELECT* sets the best suitable detector for each trace display mode (Clear Write, Max Hold oder Min Hold).

Only one of the softkeys for the detectors can be activated at any one time.

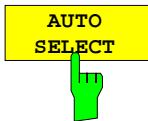

The *AUTO SELECT* softkey (= default) selects the optimum detector for the selected trace display mode (clear write, max hold, min hold).

| <u>Trace-mode</u> | <u>Detector</u> |
|-------------------|-----------------|
| Clear/Write | Autopeak |
| Average | Sample |
| Max Hold | Max Peak |
| Min Hold | Min Peak |

IEC/IEEE-bus command
 :[SENSE<1|2>:]DETEctor<1..4>:AUTO ON|OFF



The *DETECTOR AUTOPEAK* softkey selects the autopeak detector.

IEC/IEEE-bus command :[SENSE<1|2>:]DETEctor<1..4> APEak



The *DETECTOR MAX PEAK* softkey selects the max peak detector. It is recommended for pulse-like signals.

IEC/IEEE-bus command :[SENSE<1|2>:]DETEctor<1..4> POSitive



The *DETECTOR MIN PEAK* softkey selects the min peak detector. Weak sinewave signals can be brought out clearly against noise by using this detector. For a composite signal made up of sinewaves and pulse-like-like signals the pulse signals are suppressed.

IEC/IEEE-bus command :[SENSE<1|2>:]DETEctor<1..4> NEGative



The *DETECTOR SAMPLE* softkey selects the sample detector.

It is used for measuring uncorrelated signals such as noise. The power can be determined by means of fixed correction factors for evaluation and the log amplifier.

IEC/IEEE-bus command :[SENSE<1|2>:]DETEctor<1...4> SAMPlE

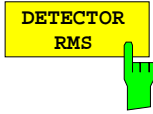

The *DETECTOR RMS* softkey activates the rms detector.

The rms detector gives the true power of the signal irrespective of the waveform. The mean of the squares of all level samples is formed as a pixel is swept. The sweep time, therefore, determines the number of values averaged and, with increasing sweep time, better averaging is obtained. The rms detector is therefore an alternative to averaging over several sweeps (see *TRACE AVERAGE*).

In the time domain ($SPAN = 0$), the rms detector is only available for sweep times ≥ 5 ms. Moreover, the combination of the rms detector with the pretrigger function and the gaped sweep function is not permissible.

The video bandwidth has to be set to at least 10 times the resolution bandwidth (RBW) so that the rms value of the signal is not invalidated by video filtering.

IEC/IEEE-bus command :[SENSE<1|2>:]DETEctor<1...4> RMS

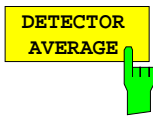

The *DETECTOR AVERAGE* softkey activates the average detector.

In contrast to the rms detector, the average detector supplies the straight average of all the level sampled as a pixel is swept over.

The same restrictions as those of the rms detector apply (see above).

IEC/IEEE-bus command :[SENSE<1|2>:]DETEctor<1...4> AVERAge

Quasi Analog Display

Normally, when measured values are displayed they are joined together with line segments to form a trace which is deleted and redrawn after each sweep. When analog measurements are performed, the persistence of the screen makes it possible to assess the signal's frequency of occurrence. Frequently occurring events appear brighter on the screen than events that occur less frequently.

The *ANALOG TRACE* function simulates an analog display.

In this case, a measured value is represented by a single pixel on the screen. After the trace has been explicitly cleared with *CLEAR / WRITE*, *this pixel is reset*. As the trace is build up from several sweeps, the frequency distribution is, in effect, indicated by the varying brightness of the trace.

TRACE 1 side menu



The *ANALOG TR ON/OFF* switches the quasi-analog display mode on and off for the selected trace

The measurement is always made with the selected detector.

IEC/IEEE-bus command

```
:DISPlay[:WINDow<1|2>]:TRACe<1..4>:MODE:ANALog ON | OFF
```

Mathematical Functions for Traces

TRACE 1-TRACE MATH submenu:

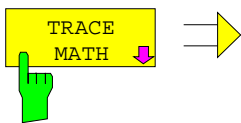

- TRACE MATH
- T1-T2+REF
-> T1
- T1-T3+REF
-> T1
- T1-T4+REF
-> T1
- T1-REF
->T1
-
-
-
-
- ADJUST TO TRACE
- TRACE MATH OFF

The *TRACE MATH* softkey opens a submenu in which a differential curve for the selected trace is calculated.

TRACE MATH

T1-T2+REF
-> T1

T1-T3+REF
-> T1

T1-T4+REF
-> T1

T1-REF
->T1



The *T1-T2+REF*, *T1-T3+REF*, *T1-T3+REF* and *T1-REF* softkeys subtract the traces and add the set level to the difference. If the reference line is switched on (see key D LINES), the level value of the reference line instead of the reference level is added to the difference. Thus, the differential curve can be positioned anywhere on the screen by shifting the reference line. The difference of the two traces with respect to the reference line is displayed.

The *T1-REF* softkey subtracts the level of the reference line from the trace level.

To indicate that the trace is a difference trace, an enhancement label is displayed at the right margin of the measurement value diagram (1-2, 1-3, 1-4, 1-R). In *TRACE 1* main menu, the *TRACE MATH* softkey is on a coloured background to show that the function is being used.

Important: For a display with two measurement windows, not all combinations are allowed if the sweep data for screen A and screen B are not the same. Only the traces allowed in the screen can be combined (in screen A, only trace 1 with trace 3; in screen B, only trace 2 with trace 4).

IEC/IEEE-bus command

```
:CALCulate<1|2>:MATH<1..4>:STATe ON
:CALCulate<1|2>:MATH<1..4>[:EXPRession][:DEFine] <expr>
```

TRACE MATH
OFF



The *TRACE MATH OFF* softkey switches the math function off. The softkey is only available when a conversion function is enabled.

IEC/IEEE-bus command :CALCulate<1|2>:MATH<1...4>:STATe OFF

ADJUST TO
TRACE



The *ADJUST TO TRACE* softkey restores the original instrument settings when the corresponding trace is set to *VIEW* and the current instrument settings are different than those of the trace data.

If a trace is frozen with *VIEW*, changes in the instrument settings can be made without influencing the trace. An asterisk (*) at the edge of the display screen indicates that the current instrument settings are different than those in effect when the trace was recorded. In this case, the *ADJUST TO TRACE* softkey is presented with which the original instrument setting can be restored.

IEC/IEEE-bus command --

Trace Export

TRACE 1 menu:



The *ASCII EXPORT* softkey stores the active trace in a file with ASCII format. Upon pressing the *ASCII EXPORT* softkey, a file name can be entered. The default name is TRACE.DAT. Then the measured data of the trace are stored. The function can be configured in the *ASCII CONFIG* submenu.

IEC/IEEE-bus command :MMEMory:STORe:TRACe 1..4,<path>

TRACE 1 menu:

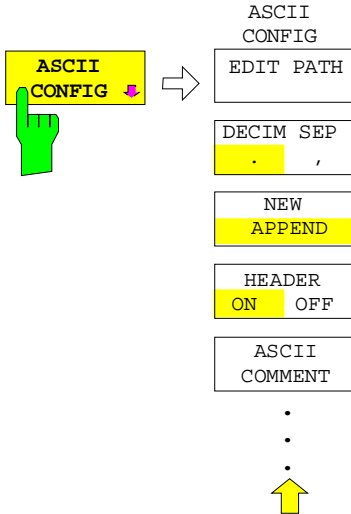

The *ASCII CONFIG* softkey calls a submenu for various settings for the *TRACE ASCII EXPORT* function.



The *EDIT PATH* softkey defines the directory in which the file is to be stored.

IEC/IEEE-bus command --



The *DECIM SEP* softkey selects the decimal separator for the ASCII file. The choice is '.' (decimal point) or ',' (comma). This means that the decimal separator used in various language versions of evaluation programs (e.g. MS-Excel) can be selected so that the packages are supported.

IEC/IEEE-bus command :FORMat:DEXPort:DSEparator POINT|COMMA



The *APPEND NEW* softkey defines whether output data are to be written to an existing file or a new file.

- With *APPEND*, the data are added to an existing file.
- With *NEW*, either a new file is generated or an existing file is overwritten by storage of the data.

IEC/IEEE-bus command :FORMat:DEXPort:APPend ON | OFF

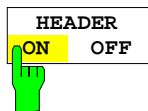

The *HEADER ON/OFF* softkey defines whether important instrument settings should be stored at the beginning of the file.

IEC/IEEE-bus command :FORMat:DEXPort:HEADer ON | OFF



The *ASCII COMMENT* softkey activates the entry of commentary concerning the current ASCII data set. A total of 60 characters are available for this purpose.

IEC/IEEE bus command :FORMat:DEXPort:COMMeNt 'string'

Structure of the ASCII file:

The file consists of the header containing important scaling parameters and a data section containing the trace data. The data of the file header consist of three columns, each separated by a semicolon: parameter name; numeric value; basic unit

The data section starts with the keyword " Trace <n> " (<n> = number of stored trace), followed by the measured data in one or several columns (depending on measurement) which are also separated by a semicolon.

This format can be read in from spreadsheet calculation programs, eg MS-Excel. It is necessary to define ';' as a separator.

| | Content of file | Description |
|---------------------------------|---|--|
| File header | Type;FSEA 30; | Instrument model |
| | Version;1.93; | Firmware version |
| | Date;01..Jul 1999; | Date record storage date |
| | Comment; test | Comment |
| | Mode;Spectrum; | Instrument operating mode |
| | Start;10000;Hz | Start/stop of the display range. |
| | Stop;100000;Hz | Unit: Hz for span > 0, s for span = 0, |
| | Center Freq;55000;Hz | Center frequency |
| | Span;90000;Hz | Frequency range (0 Hz for zero span) |
| | Freq Offset;0;Hz | Frequency offset |
| | x-Axis;LIN; | Scaling of x axis linear (LIN) or logarithmic (LOG) |
| | y-Axis;LOG; | Scaling of y axis linear (LIN) or logarithmic (LOG) |
| | Ref.Level;-30;dBm | Reference level |
| | Level Offset;0;dB | Level offset |
| | Max Level | Maximum level |
| | Level Range;100;dB | Display range in y direction. Unit: dB for x axis LOG, % for x axis LIN |
| | RF Att;20;dB | Input attenuation |
| | RBW;100000;Hz | Resolution bandwidth |
| | VBW;30000;Hz | Video bandwidth |
| SWT;0.005;s | Sweep time | |
| Trace Mode;AVERAGE; | Display mode of trace: CLR/WRITE,AVERAGE,MAXHOLD,MINHOLD | |
| Detector;SAMPLE; | Detector set: AUTOPEAK,MAXPEAK,MINPEAK,AVERAGE, RMS,SAMPLE | |
| Sweep Count;20; | Number of sweeps set | |
| Data section of the file | Trace 1;; | Selected trace |
| | x-Unit;Hz; | Unit of x values: Hz for span > 0; s for span = 0; dBm/dB for statistics measurements |
| | y-Unit;dBm; | Unit of y values: dB*/V/A/W depending on the selected unit for y axis LOG or % for y axis LIN |
| | Values;500; | Number of measurement points |
| | 10000;-10.3;-15.7 | Measured values: <x value>, <y1>, <y2> |
| | 10180;-11.5;-16.9 | <y2> being available only with AUTOPEAK detector and containing in this case the smaller of the two measured values for a measurement point. |
| 10360;-12.0;-17.4 | | |
| ...;...; | | |

Example:

```

Type;FSEA 30;
Version;1.93;
Date;20.Sep 1999;
Comment; test
Mode;Spectrum;
Start;0.000000;Hz
Stop;3500000000.000000;Hz
Center Freq;1750000000.000000;Hz
Span;3500000000.000000;Hz
Freq Offset;0.000000;Hz
x-Axis;LIN;
y-Axis;LOG;
Level Range;100.000000;dB
Ref. Level;-20.000000;dBm
Level Offset;0.000000;dBm
Max. Level;-20.000000;dBm
RF Att;10.000000;dB
RBW;3000000.000000;Hz
VBW;3000000.000000;Hz
SWT;0.005000;s
Trace Mode;CLR/WRITE;
Detector;AUTOPEAK;
Sweep Count;0;
TRACE 1:
x-Unit;Hz;
y-Unit;dBm;
Values;500;
0.000000;-44.465958;-60.190887
7014028.056112;-49.233063;-81.451668
14028056.112224;-75.692101;-101.811501
21042084.168337;-75.147057;-101.229843
28056112.224449;-75.114517;-95.358429
35070140.280561;-71.769005;-100.755981
...

```

If all traces are to be stored in one file with the header information stored only once, the following procedure is recommended:

| | |
|----------------------------------|---------------------------|
| [TRACE 1] [MENU ⇒][ASCII CONFIG] | |
| [ASCII CONFIG] [NEW] | Generate new file |
| [ASCII CONFIG] [HEADER ON] | with header |
| [TRACE 1] [MENU ⇒][ASCII EXPORT] | Store trace 1 with header |
| | |
| [TRACE 2] [MENU ⇒][ASCII CONFIG] | |
| [ASCII CONFIG] [APPEND] | Append to end of file |
| [ASCII CONFIG] [HEADER OFF] | without header |
| [TRACE 2] [MENU ⇒][ASCII EXPORT] | Write trace 2 to file |
| [TRACE 3] [MENU ⇒][ASCII EXPORT] | Write trace 3 to file |
| [TRACE 4] [MENU ⇒][ASCII EXPORT] | Write trace 4 to file |

Sweep Control – SWEEP Key Group

Using the *SWEEP* key group, the parameters are entered which determine the sweep characteristics. These are the coupled functions resolution bandwidth, video bandwidth and sweep time (*COUPLING* key), the trigger used for starting the sweep (*TRIGGER* key) and the type of sweep (*SWEEP* key).

Coupled Settings – COUPLING Key

The *COUPLING* key calls a menu for entering the sweep parameters resolution bandwidth (*RBW*), video bandwidth (*VBW*) and sweep time (*SWT*). The parameters may be coupled as a function of the span, coupled to each other or set by the user. When working with a split screen display, the settings always refer to the active window.

The models of the FSE family offer the following resolution bandwidths:

- models 20: 10 Hz to 10 MHz in 1/2/3/5 steps
- models 30: 1 Hz to 10 MHz in 1/2/3/5 steps

The FSE resolution bandwidths up to 1 kHz have been implemented using digital filters with Gaussian characteristics. They behave like analog filters. The 1-kHz filter has been implemented both as a decoupled quartz filter and as a digital filter. One of the two filter types can be selected. The bandwidths from 2 kHz to 30 kHz have been implemented using decoupled quartz filters, the bandwidths between 50 kHz and 5 MHz using decoupled LC filters. These filters consist of 4 circuits for models 20 and 5 circuits for models 30. Moreover, the filters for models 20 and 30 differ in their shape factor: The 60 dB :3 dB shape factor of the 4-circuit filters is < 15, typ. 12; the shape factor of the 5-circuit filters is < 12, typ. 9.5.

The 10-MHz filter is a critically coupled LC filter.

For bandwidths up to about 1 kHz, the FFT-algorithm, as compared to other filter methods with identical settings, offers clear advantages with respect to the measurement time. The reason is that with analog filters the sweep time required for a particular span is proportional to $(\text{Span}/\text{RBW}^2)$. The FFT-algorithm reduces that time to a value proportional to (Span/RBW) .

FFT-filters are provided for models 30 and for bandwidths between 1 Hz and 1kHz as an alternative to the analog filters. This function is provided as an option (FSE-B5).

The video bandwidths are available in 1/2/3/5 steps between 1 Hz and 10 MHz. They can be set as a function of the resolution bandwidth. Video bandwidths between 1 Hz and 10 kHz are available for resolution bandwidths up to 1 kHz and video bandwidths between 1 Hz and 10 MHz are available for resolution bandwidths greater than or equal to 2 kHz. The video filters are used to smooth the traces. Small video bandwidths in relation to the resolution bandwidth average out noise peaks and pulse-like signals, so that only the signal average is displayed. A large video bandwidth in relation to the resolution bandwidth is therefore recommended when measuring pulse-like signals ($\text{VBW} \geq 10 \times \text{RBW}$) so that the amplitude of pulses can be measured correctly.

Setting and Coupling the Coupling Resolution, Video Bandwidth and Sweep Time

SWEEP COUPLING menu

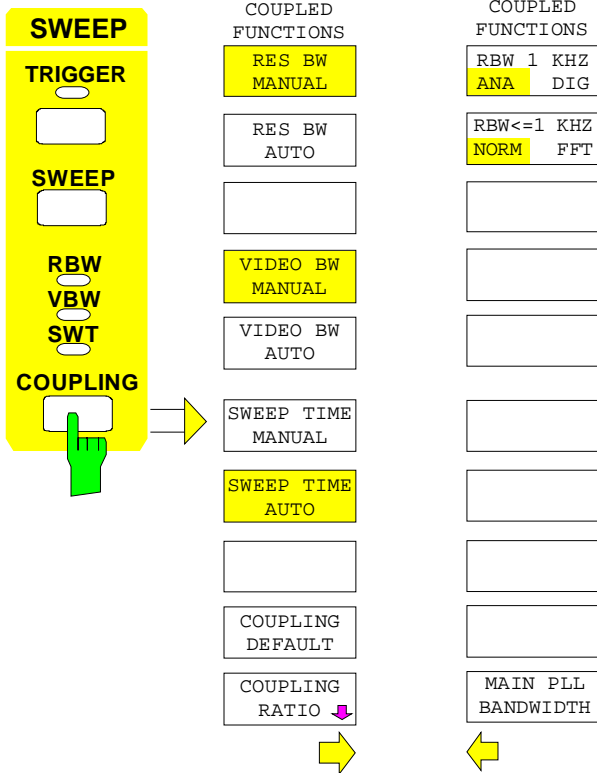

The *COUPLING* key calls a menu and a supplementary menu for setting the resolution bandwidth, video bandwidth, sweep time and their coupled states.

The *AUTO* softkeys are used to couple the functions. The coupling ratios are selected in the *COUPLING RATIO* sub-menu.

The *MANUAL* softkeys request that the respective parameter be entered in the entry window. This parameter is not coupled to the other parameters.



The *RES BW AUTO* softkey couples the resolution bandwidth to the selected span. Changing the span causes automatic compensation of the resolution bandwidth.

Automatic coupling of the resolution bandwidth to span is always recommended when, for the measurement problem on hand, a favorable setting of the resolution bandwidth in relation to the selected span is desired.

The coupling ratio is set in the *COUPLING RATIO* sub-menu.

The coupling is indicated by illumination of the softkey and the active *RBW* LED.

The *RES BW AUTO* softkey is only available in the frequency domain (span > 0 Hz). The softkey is blanked in the time domain.

IEC/IEEE-bus command : [SENSE<1|2>:]BWIDth[:RESolution]:AUTO ON

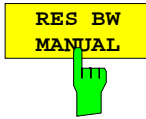

The *RES BW MANUAL* softkey activates the manual entry mode for the resolution bandwidth.

The resolution bandwidth for models 20 can be set in 1/2/3/5 steps in the range between 10 Hz and 10 MHz. The nominal resolution bandwidth is the 3-dB bandwidth. For models 20 equipped with an FFT-filter (option FSE-B5) and for models 30 the lower limit of the bandwidth is 1 Hz.

For numerical inputs, the values are always rounded to the next valid bandwidth. For rollkey or the UP/DOWN key entries, the bandwidth is adjusted in steps either upwards or downwards.

For manual input of the resolution bandwidth (coupling off), the *RBW* LED on the front panel remains off.

IEC/IEEE-bus commands

```
: [SENSe<1 | 2> : ] BWIDth [ : RESolution ] : AUTO OFF
: [SENSe<1 | 2> : ] BWIDth [ : RESolution ] 1MHz
```



The *VIDEO BW AUTO* softkey couples the video bandwidth of the FSE to the resolution bandwidth. If the resolution bandwidth is changed, the video bandwidth is automatically adjusted.

The coupling of the video bandwidth is always recommended when the maximum sweep time for a selected resolution bandwidth is to be obtained. Small video bandwidths require longer sweep times due to the longer settling time. Large bandwidths reduce the signal/noise ratio.

The coupling ratio is set in the *COUPLING RATIO* menu.

The coupling is indicated by illumination of the softkey and the lighted *VBW* LED on the front panel.

The coupling of the video bandwidth to the resolution filter is also permitted for display in the time domain (span = 0).

IEC/IEEE-bus command : [SENSe<1 | 2> :] BWIDth : VIDEo : AUTO ON



The *VIDEO BW MANUAL* softkey activates the manual entry for the video bandwidth.

The video bandwidth can be selected in 1/2/3/5 steps between 1 Hz and 10 MHz. For bandwidths up to 1 kHz, the maximum video bandwidth is 10 kHz, for larger resolution bandwidths, there is no restriction to the video bandwidth.

For numerical entries, rounding is made to the next valid bandwidth. For rollkey or UP/DOWN entries, the bandwidth is adjusted in steps either downwards or upwards.

For manual input, the video bandwidth (coupling disabled) *VBW* LED on the front panel is turned off.

IEC/IEEE-bus commands : [SENSe<1 | 2> :] BWIDth : VIDEo : AUTO OFF
: [SENSe<1 | 2> :] BWIDth : VIDEo 10kHz

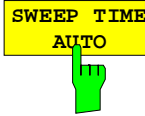

The *SWEEP TIME AUTO* softkey couples the sweep time to the span, video bandwidth (VBW) and resolution bandwidth (RBW). The sweep time is automatically adjusted whenever the span, resolution bandwidth or video bandwidth are changed. The FSE always selects the shortest sweep time which will not lead to spurious measurements.

The coupling is indicated by illumination of the softkey and turning on the *SWT LED*.

The softkey is only available in the frequency domain (span > 0 Hz). The softkey is blanked in the time domain.

IEC/IEEE-bus command : [SENSe<1 | 2>:]SWEep:TIME:AUTO ON



The *SWEEP TIME MANUAL* softkey activates the manual entry for the sweep time. At the same time, the coupling of the sweep is cancelled and the *SWT LED* is turned off. Other couplings (*VIDEO BW*, *RES BW*) remain in effect.

In the frequency domain (span > 0 Hz) and for resolution bandwidths ≥ 1 kHz, sweep times from 5 ms through 16000 s are allowed in steps that are at most 5% of the sweep time. The digital resolution filters from 10 Hz to 1 kHz allow a minimum sweep time of 20 ms.

If an FFT-filter is used (models 20 with option FSE-B5 or models 30) the sweep time is fixed by the display range and resolution bandwidth selected and therefore can not be changed.

In the time domain (span = 0 Hz), the sweep time range is 1 μ s to 2500 s, selectable in steps that are at most 5% of the sweep time.

Numerical entries are rounded to the next valid sweep time. For rollkey or UP/DOWN entries, the sweep time is adjusted in steps either downwards or upwards.

If the selected sweep time is too small for the selected span and bandwidth, measurement errors will occur. This happens because the available settling time for the resolution filter or the video filter is too short. The FSE, therefore, outputs *UNCAL* on the display

IEC/IEEE-bus commands : [SENSe<1 | 2>:]SWEep:TIME:AUTO OFF
: [SENSe<1 | 2>:]SWEep:TIME 10s

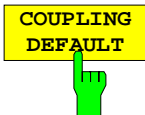

The *COUPLING DEFAULT* softkey sets all coupled functions to *AUTO*. The *RBW / VBW* ratio is also set to *SINE [1]* and the *SPAN/RBW* ratio is set to 50 in the *COUPLING RATIO* submenu (default setting, *COUPLING RATIO* softkey not illuminated).

The relevant softkeys are then illuminated.

IEC/IEEE-bus commands : [SENSe<1 | 2>:]BWIDth[:RESolution]:AUTO ON;
: [SENSe<1 | 2>:]BWIDth:VIDeo:AUTO ON;
: [SENSe<1 | 2>:]SWEep:TIME:AUTO ON

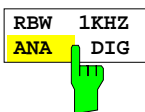

The *RBW 1kHz ANA/DIG* softkey enables either the analog quartz filter (ANA) or the digital filter (DIG) for the instrument's resolution bandwidth of 1 kHz. In the default setting, the instrument uses the analog IF filter for the 1-kHz bandwidth.

IEC/IEEE-bus command : [SENSe<1 | 2>:]BWIDth:MODE ANALog | DIGital

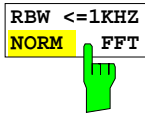

The *RBW<=1kHz NORM/FFT* softkey toggles between fixed filter and FFT-filter.

This softkey for models 30 of the FSE or for models 20 equipped with option FFT-filter (FSE-B5).

NORM For resolution bandwidths up to 1 kHz fixed IF-filters are used.

FFT An FFT is performed. The filtered IF-signal is digitalized by the 3-kHz resolution filters and then transformed into a spectrum by FFT. The transformation range is equal to the selected span but covers 4 kHz at maximum. If the span is larger than the transformation range, several subsequent transformations are performed, the results are combined to form a complete spectrum. The frequency response of the 3-kHz preselection filter is compensated for so that the amplitude response within the transformation range is offset. A flattop window serves as a window in the time domain so that a high amplitude precision with good selectivity is obtained.

Span:

- minimum display range: 50× resolution bandwidth selected
- maximum display range:
 - Resolution bwidths > 20 Hz: 2 MHz (500 FFT-transf./sweep at maximum)
 - Resolution bwidths < 20Hz: Reduction to 125 kHz at 1 Hz resolution bandwidth

Level display range: 100 dB at max. With greater spans, the trace is limited to 100 dB below the reference level.

Sweep time: fixed by the bandwidth selected and the span.
(reason: an FFT-filter represents a block transformation). The sweep time can not be changed (softkey inactive).

Detector All settings of the sample detector are fixed, no other detector can be selected (softkeys inactive)

Video bandwidth not defined for FFT-transf. therefore it can not be set (softkeys inactive).

Compared to fixed filters, FFT-filters cut sweep times considerably. For a display range of 50 kHz and a resolution bandwidth of 100 Hz, e. g., the sweep time is reduced from 25 s to 520 ms. FFT-filters are ideal for stationary signals (sinusoidal signals or signals that are continuously modulated in time). For burst signals (TDMA) or pulses, fixed filters should be preferred. The FFT is a block transformation so that the result depends on the time relation between the dataset to be transformed and the burst or pulse signal. A 'gated sweep' measurement for TDMA signals is therefore not provided if FFT-filters are used.

IEC/IEEE-bus command : [SENSE<1 | 2> :]BWIDTH:MODE:FFT ON|OFF

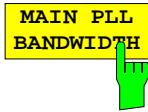

The *MAIN PLL BANDWIDTH* softkey opens a selection window for setting the PLL control bandwidth.

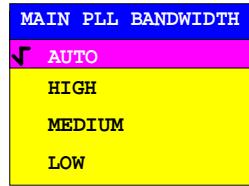

The first local oscillator is synchronized with the PLL control bandwidth. The control bandwidth determines the characteristic of the phase noise. A medium or high control bandwidth improves the phase noise for frequency differences smaller than 10 kHz to the carrier, whereas a low control bandwidth improves the phase noise for frequency differences larger than 100 kHz to the carrier. If the control bandwidth is set unfavorably, the phase noise is deteriorated.

The PLL bandwidth is set in the AUTO mode depending on the RBW and SPAN according to the following tables:

Models 20 without option B4:

| MAIN PLL BANDWIDTH | SPAN ≤ 50 kHz and RBW < 1kHz | SPAN > 50 kHz or RBW ≥ 1kHz |
|--------------------|---------------------------------|--------------------------------|
| HIGH | | |
| MEDIUM | X | |
| LOW | | X |

Models 30 or models 20 with Option B4:

| MAIN PLL BANDWIDTH | SPAN ≤ 100 kHz and RBW < 3kHz | SPAN > 100 kHz or RBW ≥ 3kHz |
|--------------------|----------------------------------|---------------------------------|
| HIGH | X | |
| MEDIUM | | X |
| LOW | | |

The setting is chosen such that the phase noise for small spans with small resolution bandwidth near the carrier is optimized.

For measurements with small span but with a relatively large frequency difference to the carrier (>100kHz), the automatic bandwidth setting deteriorates the phase noise relative to the optimal setting. The *MAIN PLL BANDWIDTH* softkey allows to by-pass this automatic setting. Optimal settings are, as a function of the carrier difference @:

Models 20 without option B4:

| MAIN PLL BANDWIDTH | @ ≤ 10 kHz | @ > 10 kHz |
|--------------------|------------|------------|
| HIGH | | |
| MEDIUM | X | |
| LOW | | X |

Models 30 or Models 20 with Option B4:

| MAIN PLL BANDWIDTH | @ ≤ 10 kHz | 10 kHz < @ < 100 kHz | @ ≥ 100 kHz |
|--------------------|------------|----------------------|-------------|
| HIGH | X | | |
| MEDIUM | | X | |
| LOW | | | X |

If a larger control bandwidth is needed due to the sweep velocity, the processor automatically increases the control bandwidth as far as necessary.

Sweep Coupling Ratio

SWEEP COUPLING-COUPLING RATIO submenu:

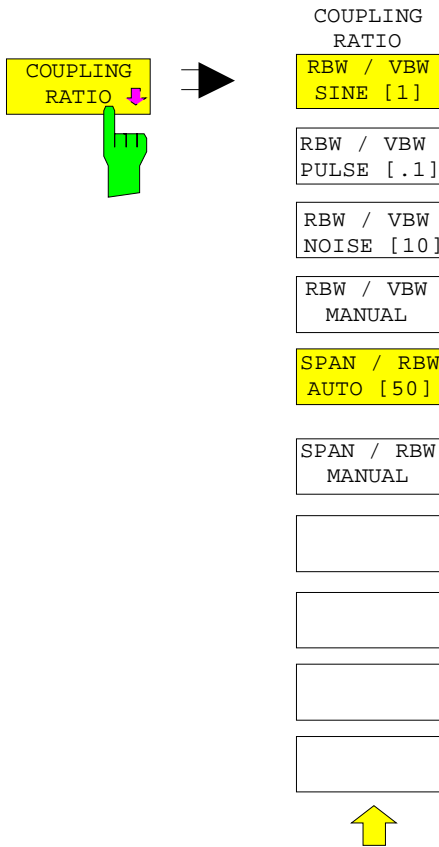

The *COUPLING RATIO* softkey opens a sub-menu in which the coupling ratio between resolution bandwidth, video bandwidth and the span can be defined.

These settings are effective only for the selected parameters in ...*AUTO* of the main menu.

The softkeys *RBW/VBW PULSE*, *RBW/VBW SINE*, *RBW/VBW NOISE*, *RBW/VBW MANUAL* are selection keys. Only one softkey can be enabled (illuminated) at any one time.

The same is valid for the softkeys *SPAN/RWB AUTO [50]* and *SPAN/RWB MANUAL*.

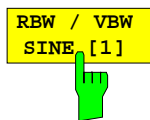

The *RBW / VBW SINE [1]* softkey always sets the video bandwidth equal to the resolution bandwidth.

This is the default setting for the coupling ratio resolution bandwidth to video bandwidth.

This coupling ratio is recommended when sine-wave signals are to be measured.

This setting is only effective for the *VBW AUTO* selection in the main menu.

IEC/IEEE-bus command : [SENSe<1|2>:]BWIDth:VIDeo:RATio SINE

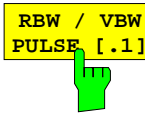

The *RBW / VBW PULSE* softkey sets the following coupling ratio:

video bandwidth = 10 x resolution bandwidth

or

video bandwidth = 10 MHz (= maximum video bandwidth).

This coupling ratio is recommended when the amplitude of pulsed signals is to be measured. The IF filter characteristics alone determine the pulse shape. No additional weighting is provided by the video filter.

This setting is only effective for the *VBW AUTO* selection in the main menu.

IEC/IEEE-bus command : [SENSE<1|2>:]BWIDth:VIDeo:RATio PULSe

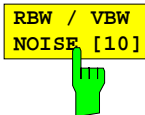

The *RBW / VBW NOISE* softkey sets the following coupling ratio:

video bandwidth = resolution bandwidth/10

At this coupling ratio, noise and pulsed signals are suppressed in the video section. For noise signals, the FSE displays the average value.

This softkey is disabled unless *VBW AUTO* is selected in the main menu.

IEC/IEEE-bus command

: [SENSE<1|2>:]BWIDth:VIDeo:RATio NOISE

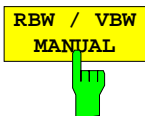

The *RBW / VBW MANUAL* softkey activates the entry of the coupling ratio for resolution bandwidth to video bandwidth.

The range for the RBW/VBW ratio is 0,001 to 1000.

This softkey is disabled unless *VBW AUTO* is selected in the main menu.

IEC/IEEE-bus command : [SENSE<1|2>:]BWIDth:VIDeo:RATio 10

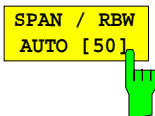

The *SPAN / RBW AUTO [50]* softkey sets the following coupling (rounding is made to the next higher value):
resolution bandwidth = span/50

This coupling corresponds to the default state.

This softkey is disabled unless *RBW AUTO* is selected in the main menu.

IEC/IEEE-bus command

: [SENSE<1|2>:]BWIDth[:RESolution]:RATio 0.02



The *SPAN / RBW MANUAL* softkey activates the entry for the coupling of resolution bandwidth and span.

The range for the SPAN/RBW ratio is 1 to 10000.

This softkey is disabled unless *RBW AUTO* is selected in the main menu.

IEC/IEEE-bus command

: [SENSE<1|2>:]BWIDth[:RESolution]:RATio 0.1

Sweep Trigger – TRIGGER Key

SWEEP TRIGGER menu:

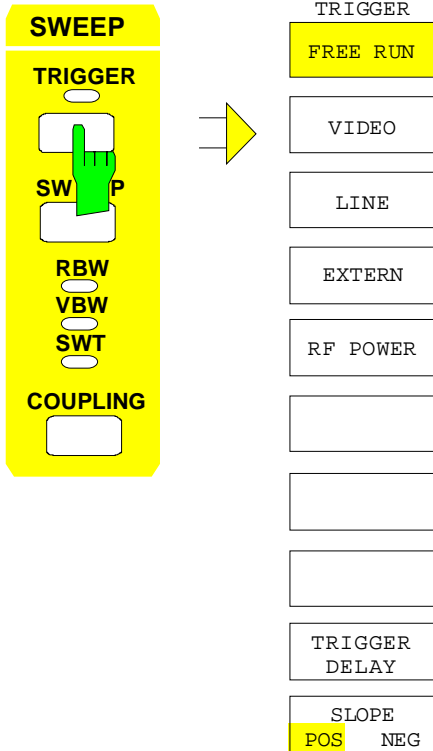

The *TRIGGER* key opens a menu for selecting the various trigger sources and the trigger polarity. The active trigger mode is indicated by illumination of the corresponding softkey.

For triggering modes in which the trigger threshold can be entered, the corresponding entry window is activated and, if appropriate, a horizontal trigger line is displayed.

The *FREE RUN*, *VIDEO*, *LINE*, *EXTERN* and *RF-POWER* softkeys are selection switches. Only one key can be enabled at any one time (illuminated). For sweep operations controlled by a gate signal, the *FREE RUN* setting is the only setting possible.

If triggering has taken place, the trigger LED is turned on at the beginning of the sweep and then turned off at the end of sweep.

To indicate that the FSE is set for triggering (= not free run), the enhancement label **TRG** is shown on the display. If two measurement windows are displayed, TRG appears next to the window which is configured for triggering.



The *FREE RUN* softkey activates the free-run sweep mode (default setting), i.e. the start of a sweep is not explicitly triggered. Once a measurement is completed, another is started immediately.

IIEC/IEEE-bus command
`:TRIGger<1|2>[:SEquence]:SOURce IMMEDIATE`

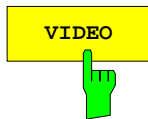

The *VIDEO* softkey activates triggering by the displayed voltage.

For the video triggering mode, a level line showing the trigger threshold is displayed. Using the level line, the threshold can be adjusted with the roll-key or the UP/DOWN keys.

IEC/IEEE-bus commands
`:TRIGger<1|2>[:SEquence]:SOURce VIDeo`
`:TRIGger<1|2>[:SEquence]:LEVel:VIDeo 50PCT`

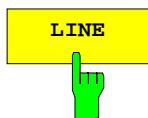

The *LINE* softkey activates triggering derived from the mains (line) frequency. The power supply generates a trigger pulse at the line frequency which is used to trigger a new sweep.

IEC/IEEE-bus commands
`:TRIGger<1|2>[:SEquence]:SOURce LINE`

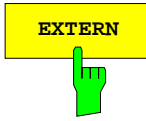

The *EXTERN* softkey activates triggering by an external voltage (-5V...+5V) at the input connector *EXT TRIGGER/GATE* on the rear panel.

The trigger threshold can be set in an entry window within a range of -5V...+5V.

External triggering in the sweep mode "gated sweep" (*SWEEP SWEEP-GATE ON*) is not possible, because the *EXT TRIG/GATE* connector is used to control the sweep. The softkey is not illuminated in these modes.

IEC/IEEE-bus commands

```
:TRIGger<1|2>[:SEquence]:SOURce EXTernal
:TRIGger<1|2>[:SEquence]:LEVel 2.5V
```

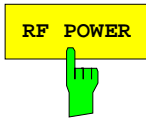

The *RF POWER* softkey activates triggering of the measurement by signals which are outside the measurement channel.

The FSE uses a level detector at the intermediate frequency. The detector threshold is approximately -20 dBm at the input mixer. This means that the actual trigger level at the RF input is approx. -20 dBm plus the set RF attenuation.

The bandwidth at the intermediate frequency is approximately 60 MHz for model FSEA, approx. 160 MHz for FSEB, FSEM and FSEK. Triggering takes place when the trigger threshold is exceeded within a 100 MHz band about the selected frequency. Therefore, the measurement of noise emissions, e.g., for pulsed carriers, is possible. The carrier itself is suppressed via the selected resolution filter.

IEC/IEEE-bus command

```
:TRIGger<1|2>[:SEquence]:SOURce RFPower
```



The *TRIGGER DELAY* softkey activates the entry window for delay time or a pretrigger.

The triggering is delayed or advanced relative to the trigger signal by the entered delay time. The delay time can be set in the range from -100 s to 100 s (default = 0 s).

Note: A negative delay time (pretrigger) can be set in the time domain (SPAN < 0 Hz) only. The maximum range and the maximum resolution of the pretrigger is limited by the set sweep time:

max. range = - 499/500 x sweep time

max. resolution = sweep time/500.

Pretriggering is not possible when the rms or the average detector is activated.

IEC/IEEE-bus command

```
:TRIGger<1|2>[:SEquence]:HOLDoff 500us
```



The *SLOPE POS/NEG* softkey selects the trigger slope.

The sweep starts after a positive or negative trigger signal edge. The selected setting is illuminated.

The selection is valid for all trigger modes with the exception of *FREE RUN*.

The default mode is *SLOPE POS*.

IEC/IEEE-bus command

```
:TRIGger<1|2>[:SEquence]:SLOPe POS |NEG
```

Sweep Setup – SWEEP Key

SWEEP SWEEP menu:

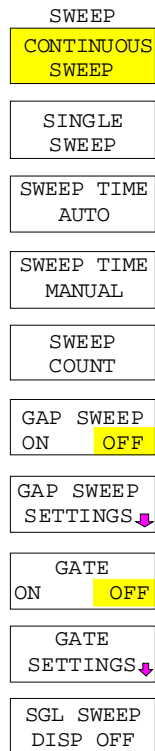
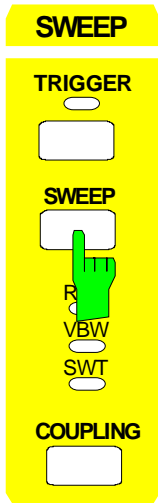

The *SWEEP* key calls a menu in which the type of sweep (sweep mode) is determined. In split screen mode, the entries are valid only for the active measurement window.

In the menu, continuous or single sweep mode, gap-sweep settings or the external gate function can be selected.

The *CONTINUOUS SWEEP* and *SINGLE SWEEP* softkeys are selection switches. Only one softkey can be active at any one time.



The *CONTINUOUS SWEEP* softkey sets the continuous sweep mode. This means, that the sweep takes place continuously according to the trigger conditions.

In the case of split screen display with different settings in each measurement window, screen A is swept first and then screen B. After pressing the softkey, the sweep is initialized and restarted.

CONTINUOUS SWEEP is the default setting of the FSE.

IEC/IEEE-bus commands :INITiate<1|2>:CONTinuous ON;
:INITiate

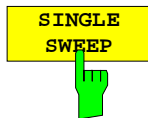

The *SINGLE SWEEP* softkey starts a series of n sweeps according to the triggering definition. The number of sweeps, n, is determined by the *SWEEP COUNT* softkey.

In split screen display mode, the spans of each window are swept sequentially. If a displayed curve is averaged, the span is swept n times (n = sweep count). For n = 0, a single sweep takes place.

To indicate that the FSE is set for single sweep, the enhancement label **SGL** is shown on the display.

IEC/IEEE-bus commands :INITiate<1|2>:CONTinuous OFF;
:INITiate

SWEEPTIME
AUTO

SWEEPTIME
MANUAL

The *SWEEPTIME AUTO* and *SWEEPTIME MANUAL* softkeys activate the automatic or manual selection of the sweep time. These functions are identical to the entries in the *COUPLING* menu (see section "Setting and Coupling the Coupling Resolution, Video Bandwidth and Sweep Time").

IEC/IEEE-bus commands

```
: [SENSE<1 | 2>: ]SWEEp:TIME:AUTO ON | OFF
: [SENSE<1 | 2>: ]SWEEp:TIME 10s
```

SGL SWEEP
DISP OFF



The *SGL SWEEP DISP OFF* softkey switches off the display during a single sweep. The trace is displayed when the sweep has been completed.

IEC/IEEE-bus commands :INITiate<1 | 2>:DISPlay ON | OFF;
:INITiate

SWEEP
COUNT



The *SWEEP COUNT* softkey activates the entry of the number of sweeps performed by the FSE after the start of a single sweep. If trace average, max hold or min hold is switched on, this also determines the number of averages or minima/maxima that are taken.

Example:

[TRACE1: MAX HOLD]

[SWEEP: SWEEP COUNT: {10} ENTER]

[SINGLE SWEEP]

The FSE performs the max hold function over 10 sweeps.

The sweep count range is 0 through 32767. For sweep count = 0 or 1, a sweep is performed. For trace averaging (*AVERAGE*), sweep count = 0 and continuous sweep, the FSE performs a sliding average over 10 sweeps in average mode. For sweep count = 1, no averaging takes place.

The default setting totals 10 sweeps.

Note: *The setting for the number of sweeps in the TRACE menu is equivalent to the setting in the SWEEP menu. In SINGLE SWEEP mode, the measurement is stopped after reaching the chosen number of sweeps.*

IEC/IEEE-bus command : [SENSE<1 | 2>:]SWEEp:COUNT 0

Gated Sweep

By using a gate in the sweep mode and stopping the measurement while the gate signal is inactive, the spectrum of pulsed carriers can be displayed without overlaid frequency components caused by switching. Similarly, the spectrum can also be examined when the carrier is inactive. The sweep can be controlled by an external gate or by the internal power trigger.

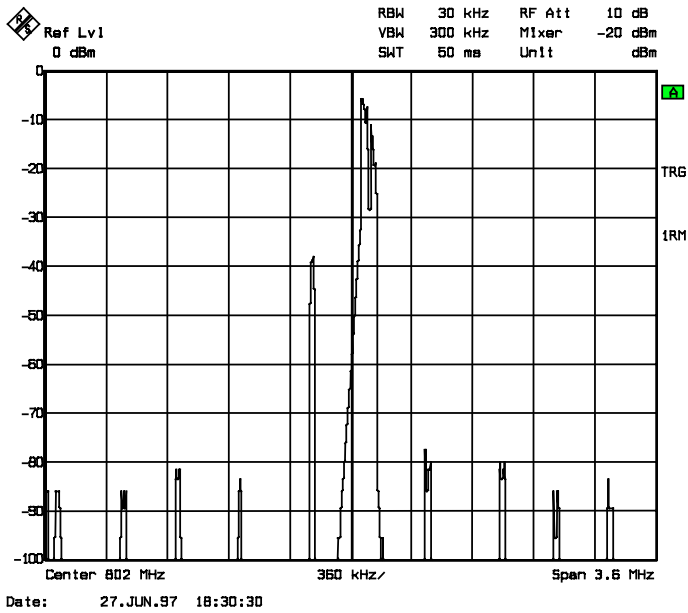

Fig. 4-8 Pulsed signal with GATE OFF

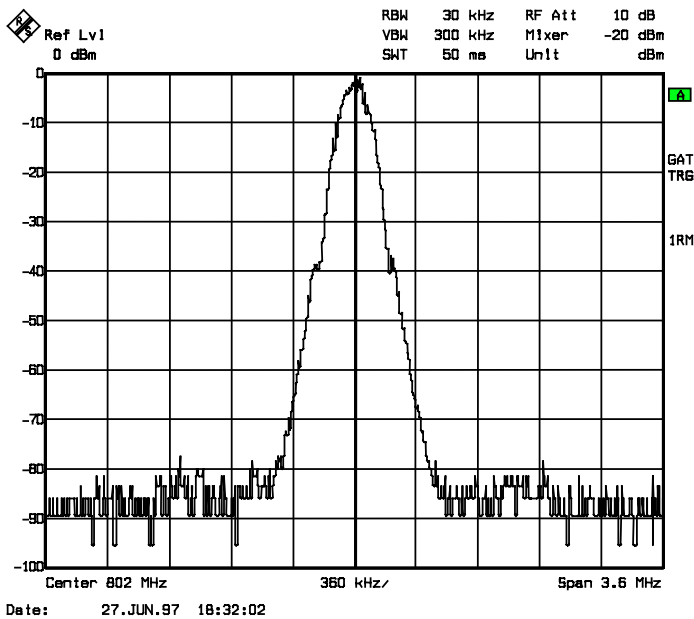
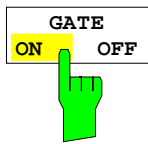

Fig 4-9 TDMA-signal with GATE ON

The 'gated sweep' mode is activated by the *GATE ON/OFF* softkey. The mode is set in the *GATE SETTINGS* sub-menu.

SWEEP SWEEP menu:



The *GATE ON / OFF* softkey switches the sweep mode with an internal or external gate on/off.

When *GATE ON* is selected, a signal applied to the rear panel connector *EXT TRIGGER/GATE* or the internal RF power detector controls the sweep of the analyzer. The sweep can be stopped and then continued. A switch from an edge triggered to a level triggered mode can also be made.

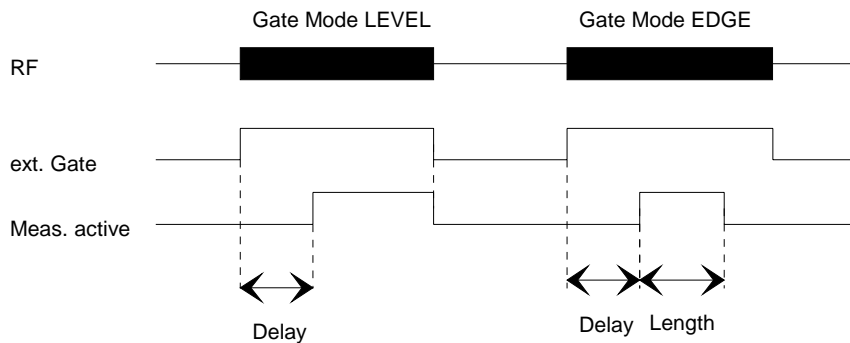

Fig. 4-10 Interaction of the parameters *GATE MODE*, *GATE DELAY* and *GATE LENGTH*

The softkey is only available in the frequency domain (span > 0).

GATE ON is only possible when the trigger mode is set to *FREE RUN* (*SWEEP TRIGGER* menu).

To indicate that the FSE is set for sweep mode with external gate, the enhancement label *GAT* is displayed on the screen. *GAT* appears next to the window for which the gate is configured.

IEC/IEEE-bus command : [SENSe<1|2>:]SWEep:EGATe ON | OFF

SWEEP SWEEP-GATE SETTINGS sub-menu:

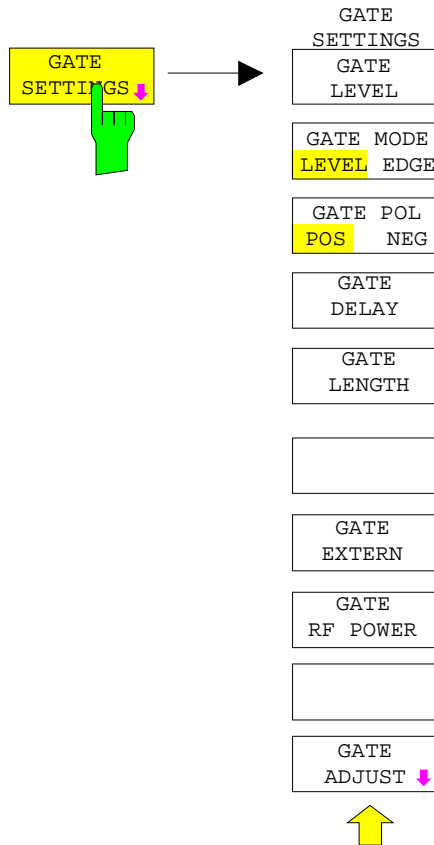

In the *GATE SETTINGS* submenu, all settings are made which are necessary for 'gated sweep' operation.

On switching to the time domain, the *GATE DELAY* and *GATE LENGTH* times are represented by horizontal time lines which allow simple adjustment of the gate time.

The softkeys *GATE EXTERN* and *GATE RF POWER* provide alternative settings, only one of them can be active at one time.



The *GATE LEVEL* softkey activates the entry window for defining the threshold value of the external gate signal.

The threshold can be set between -5V and +5V.

IEC/IEEE-bus command : [SENSE<1|2>:]SWEep:EGATe:LEVel 3V

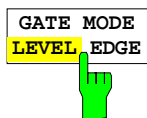

The *GATE MODE LEVEL/EDGE* softkey selects the trigger mode. The sweep mode *GATE* can be operated either as level or as edge triggered.

For level triggering, the *GATE LENGTH* softkey is deactivated and can not be used.

IEC/IEEE-bus command : [SENSE<1|2>:]SWEep:EGATe:TYPE LEVel | EDGE



The *GATE POL* softkey determines the polarity of the *GATE* control line.

If level triggering with *GATE POL POS* is set, the sweep is stopped when the gate signal is a logic '0' (input signal < gate level) at the *EXT TRIGGER/GATE* input and then, when the gate signal goes to a logic '1', the sweep is continued after a delay time of *GATE DELAY*.

In the case of edge triggering, the sweep is continued on a '0' to '1' transition for the duration of *GATE LENGTH* after a delay (*GATE DELAY*) has elapsed.

IEC/IEEE-bus command : [SENSE<1|2>:]SWEep:EGATe:POLarity POS|NEG



The *GATE DELAY* softkey activates the entry window for setting the delay time between the gate signal and the continuation of the sweep.

This may be useful in allowing for a delay between the gate signal and the stabilization of an RF carrier.

Gate delay values can be selected between 1 μ s and 100 s. The resolution is dependent upon the absolute value of the delay time:

| Gate delay | Resolution |
|-----------------|-------------|
| 0 - 500 μ s | 1 μ s |
| 0.5 - 5 ms | 5 μ s |
| 5 - 50 ms | 50 μ s |
| 50 - 500 ms | 500 μ s |
| 0.5 - 5 s | 5 ms |
| 5 - 50 s | 50 ms |
| 50 - 100 s | 500 ms |

In the time domain, a time line is displayed separated from the trigger point by the gate delay time. This simplifies the adjustment of the necessary delay time.

The values for *GATE DELAY* and *GATE LENGTH* are displayed by two time lines. The duration of the active sweep for span > 0 (continuation of sweep: *GATE DELAY* line, stopping of sweep: *GATE LENGTH* line) is described by these two lines. A change in parameters causes a shift of the corresponding line position. After switching to span > 0, the selected times for the gated sweep are effective.

IEC-bus command : [SENSE<1|2>:]SWEep:EGATE:HOLDoff 100us

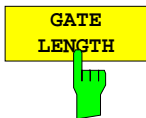

The *GATE LENGTH* softkey activates the entry window for defining the FSE sweep duration.

GATE LENGTH can be set to values between 1 μ s and 100 s. The resolution is dependent upon the absolute value of the gate length:

| Gate length | Resolution |
|-----------------|-------------|
| 0 - 500 μ s | 1 μ s |
| 0.5 - 5 ms | 5 μ s |
| 5 - 50 ms | 50 μ s |
| 50 - 500 ms | 500 μ s |
| 0.5 - 5 s | 5 ms |
| 5 - 50 s | 50 ms |
| 50 - 100 s | 500 ms |

In the time domain (*ZERO SPAN*), a time line is displayed separated from the *GATE DELAY* time by the *GATE LENGTH* time.

The softkey is only available for the *GATE MODE EDGE* setting (edge triggering). It is disabled for the *GATE MODE LEVEL* setting (level triggering).

IEC/IEEE-bus command : [SENSE<1|2>:]SWEep:EGATE:LENGth 10ms



The *GATE EXTERN* softkey selects a signal applied to the *EXT TRIGGER/GATE* connector on the rear panel of the instrument as a gate source.

IEC/IEEE-bus command : [SENSE<1|2>:]SWEep:EGATE:SOURce EXT

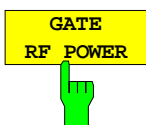

The *GATE RF POWER* softkey selects the internal RF power detector as a gate source.

IEC-bus command : [SENSE<1|2>:]SWEep:EGATE:SOURce RFPower

Setting the Gate Times

SWEEP SWEEP- GATE SETTINGS - GATE ADJUST submenu:

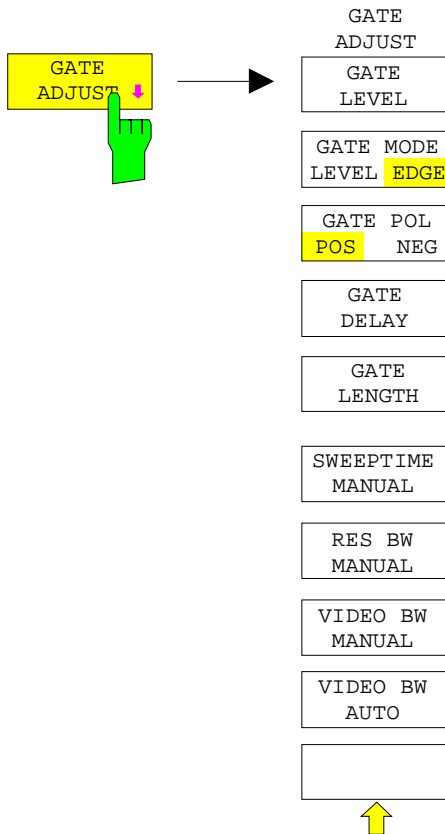

The *GATE ADJUST* softkey opens a submenu comprising all softkeys that are used to set the parameters relevant for the 'gated sweep' function.

On pressing this softkey, the display is switched to the time domain (zero span setting) so that all necessary times can be checked by means of cursor lines.

The values for Res BW, Video BW and sweep time are taken from the corresponding settings in the frequency domain.

To make sure that the times can be set correctly corresponding to the conditions in the frequency domain, the settings for the resolution bandwidth and the video bandwidth should not be changed.

The sweep time must be selected such that, e. g., a full burst is displayed. It usually differs from the sweep time in the frequency range.

Finally, *GATE DELAY* and *GATE LENGTH* can be used to set the times in such a way that the desired section in the spectral range is covered.

On quitting the submenu, the original settings in the frequency range are restored so that the measurement can be directly performed with the required parameters.

Measurement example:

The modulation spectrum of a GSM or PCS1900 signal to be measured using the 'gated sweep' function. The signal is generated by the test sender SME03. Its RF-output is directly connected to the RF input of the FSE.

Settings on the SME03:

| | |
|--------------------|------------------------------|
| FREQ: | 802 MHz |
| Level: | 0 dBm: Return |
| Digital Mod: | Select: GMSK: Select |
| Source: | Select: PRBS: Select: Return |
| Level Attenuation: | Select: 60 dB: Return |

The SME03 provides a GMSK-modulated TDMA-signal (GSM)

Operation steps on the FSE:

[PRESET]
 [CENTER: {802} MHz]
 [SPAN {3.6} MHz]
 [REF LVL: {0} dBm: RF ATTEN MANUAL: {10} dB]
 [COUPLING: RES BW MANUAL: {30} kHz]
 [TRACE 1: DETECTOR: RMS]
 [SWEEP: SWEPTIME MANUAL: {50} ms;
 GATE ON
 GATE SETTINGS: GATE MODE EDGE: GATE POL POS: GATE RF POWER

 GATE ADJUST: SWEPTIME MANUAL {1} ms: GATE DELAY {300} μs:
 GATE LENGTH: {250} μs]

Note: [KEY] Menu called by the KEY. All indications inside the bracket refer to this menu.
 {Number} Numeric value to be entered for the corresponding parameter
 SOFTKEY Softkey used to select a parameter or enter a value.

The following figure shows the screen display for gate parameter setting: The vertical lines for gate delay (GL) and gate length (GL) can be adapted to the burst signal by entering numbers or with the rollkey.

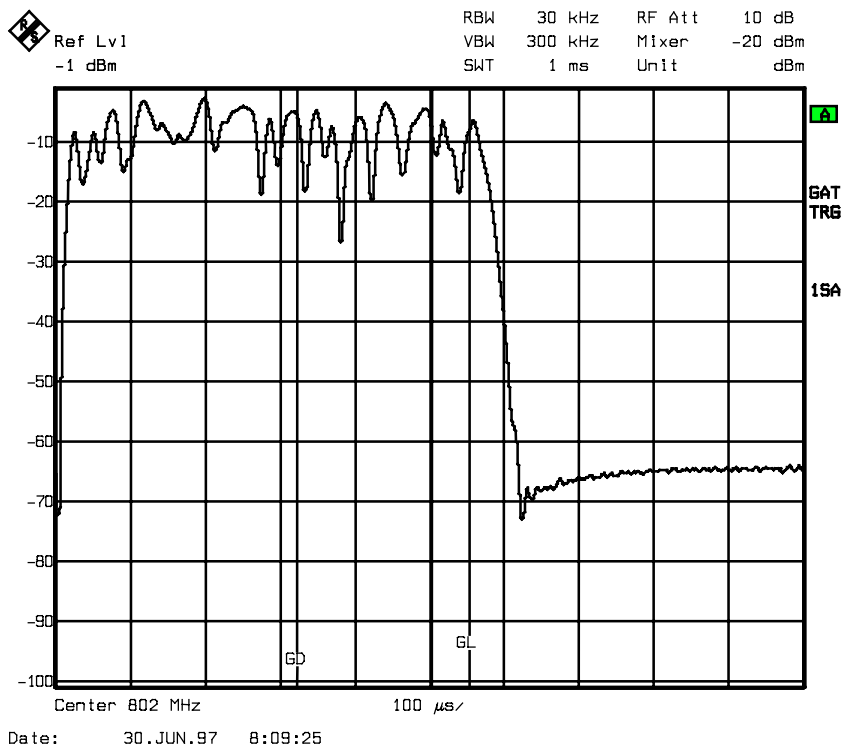

Fig. 4-11 Setting the GATE DELAY and GATE LENGTH times in the time domain using the GD and GL lines

On quitting the menu GATE ADJUST, the FSE returns to spectral representation.

Sweep Blanking – Gap Sweep

For measurements in the time domain, the *GAP SWEEP* function offers a high degree of flexibility with regard to the display of measurement data. With the *PRE TRIGGER* softkey, it is possible to display measurements taken before the trigger time. With the *GAP TIME* softkey, the measurements within a predefined time range can be blanked. Thus, it is possible to display the rising and falling edge of a signal with high resolution on a single diagram.

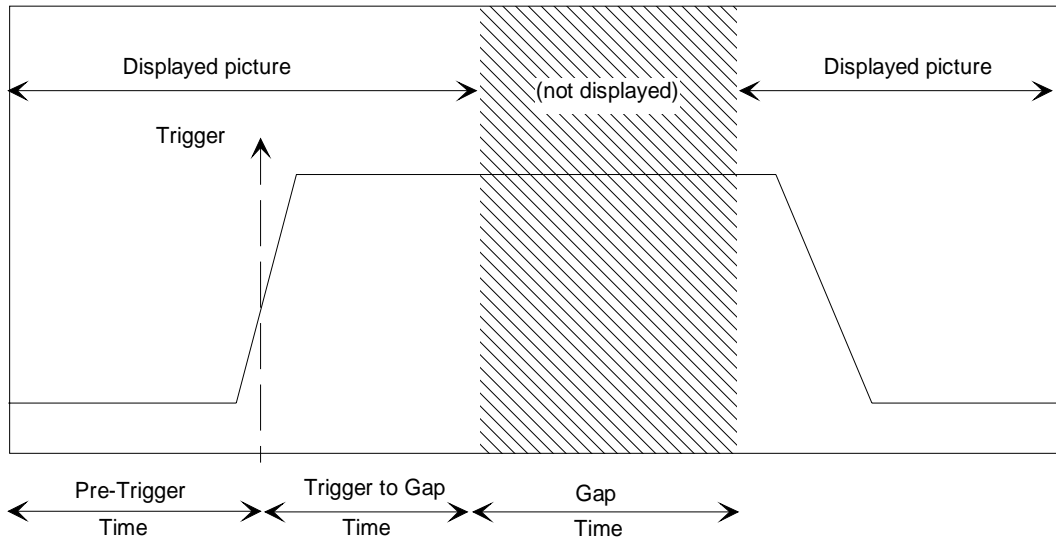

Fig 4-12 Trace blanking in sweep mode.– Gap Sweep

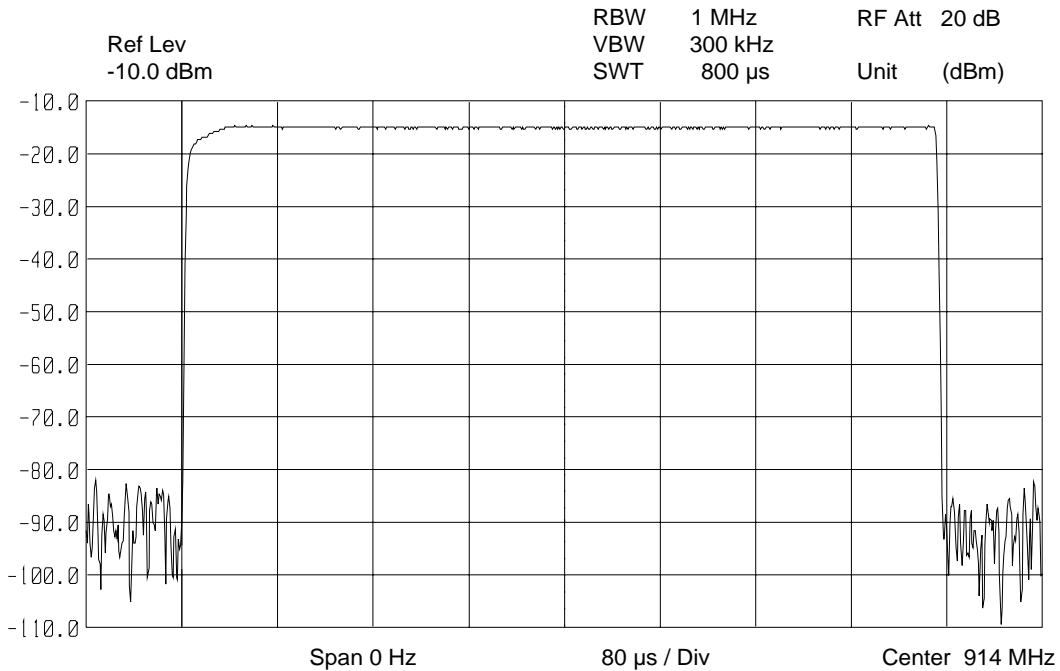

Fig. 4-13 Display of a burst without gaps

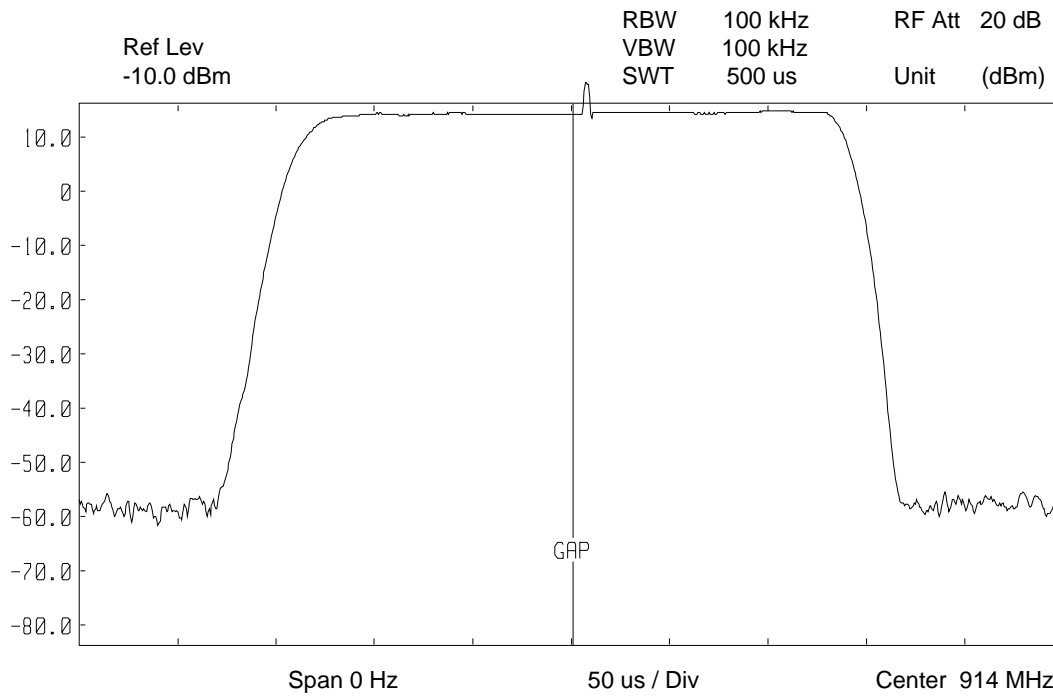
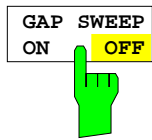

Fig. 4-14 Display of a burst with a gap

The *GAP SWEEP* measurement is activated by the *GAP SWEEP ON/OFF* softkey. The mode settings are made in the *GAP SWEEP SETTINGS* sub-menu.

SWEEP SWEEP menu:



The *GAP SWEEP ON/OFF* softkey switches the *GAP SWEEP* measurement on/off.

The softkey is available only in the time domain.

IEC/IEEE-bus command : [SENSE<1|2>:]SWEEp:GAP ON | OFF

SWEEP SWEEP-GAP SWEEP SETTINGS sub-menu:

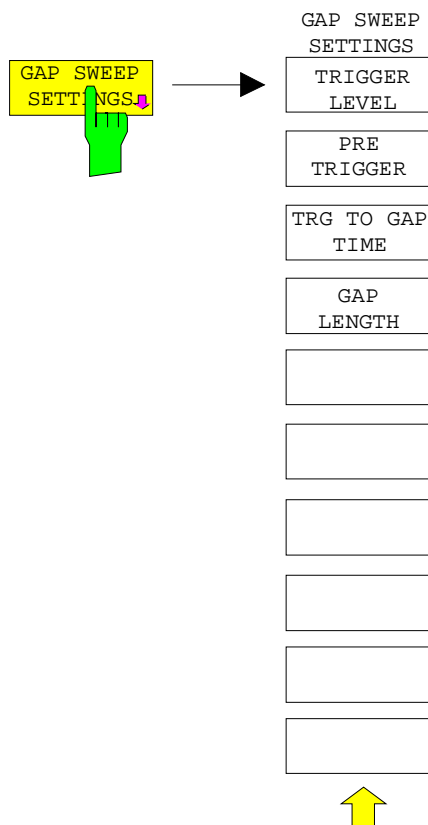

The *GAP SWEEP SETTINGS* softkey opens a sub-menu in which the parameters for the gap can be selected.

The trigger time corresponds to $t = 0$. Events occurring before the trigger time are displayed in negative time.



The *TRIGGER LEVEL* softkey activates the entry window for trigger level.

This function corresponds to the setting in the trigger menu.

IEC/IEEE-bus command

```
:TRIGger<1|2>[:SEquence]:LEVel:VIDeo 50PCT
```



The *PRE TRIGGER* softkey activates the entry window for the pre-trigger time. The pre-trigger time defines the separation between the left edge of the grid and the trigger time ($t = 0$).

At the same time the gap sweep is switched on (exception : entry $t = 0$)

The minimum pre-trigger time is -100 s, the maximum pre-trigger time depends on the sweep time and the trigger to gap time (max = 100 s). The maximum resolution is 50 ns.

The *PRE TRIGGER* value can be entered in the frequency domain (span > 0) as well as in the time domain and *GAP SWEEP OFF* mode. It is, however, only effective when the *GAP SWEEP* measurement is enabled.

IEC/IEEE-bus command

```
:SENSe<1|2>:]SWEep:GAP:PRETrigger 100us
```



The *TRG TO GAP TIME* softkey opens an entry window for defining the distance between the trigger time and the beginning of the gap.

The *TRIGGER TO GAP TIME* range is from 0 to 100 s with a resolution of 50 ns. The length of the gap is defined by *GAP LENGTH*. If the *GAP LENGTH* is 0 s, the entered value of *TRG TO GAP TIME* is only stored.

The *TRG TO GAP TIME* value can be entered in the frequency domain (span > 0) as well as in the time domain and for the *GAP SWEEP OFF* mode. It has an effect on the measurement only after the *GAP SWEEP ON* is switched on.

IEC/IEEE-bus command

```
: [SENSe<1 | 2> : ]SWEep:GAP:TRGTogap 50us
```



The *GAP LENGTH* softkey activates the entry window for defining the gap within which the measurement values are to be blanked.

The beginning of the gap is defined by *TRG TO GAP TIME*.

GAP LENGTH can be set to values between 150 ns and 100 s in 1/2/3/5 steps. The resolution is dependent upon the absolute value of the gap length:

| Gap length | Resolution |
|---------------------|-------------|
| 150 ns - 50 μ s | 50 ns |
| 50 - 500 μ s | 500 ns |
| 0.5 - 5 ms | 5 μ s |
| 5 - 50 ms | 50 μ s |
| 50 - 500 ms | 500 μ s |
| 0.5 - 5 s | 5 ms |
| 5 - 50 s | 50 ms |
| 50 - 100 s | 500 ms |

The *GAP LENGTH* value can be entered in the frequency domain (span > 0) as well as in the time domain and for the *GAP SWEEP OFF* mode. It has an effect on the measurement only after the *GAP SWEEP ON* is switched on.

IEC/IEEE-bus command

```
: [SENSe<1 | 2> : ]SWEep:GAP:LENGTh 400us
```

Tracking Generator Option

In the normal mode, the tracking generator sends a signal exactly at the input frequency of the instrument without a frequency offset.

For frequency-converting measurements it is possible to set a constant frequency offset of ± 200 MHz between the output signal of the tracking generator and the receive frequency of the instrument. Also, two analog input signals can be used to I/Q or AM and BB-FM modulate the output signal (options FSE-B9, FSE-B11).

The output level is level-controlled and can be set from -20 to 0 dBm in 0.1-dB steps. The level control can also be operated with external detectors. When the tracking generator is equipped with the optional attenuator, the setting range is extended from -90 dBm to 0 dBm.

The tracking generator can be used in all operating modes. The recording of test setup calibration values (SOURCE CAL) and the normalization with these correction values (NORMALIZE) is only possible in operating mode ANALYZER MODE.

SYSTEM MODE menu:

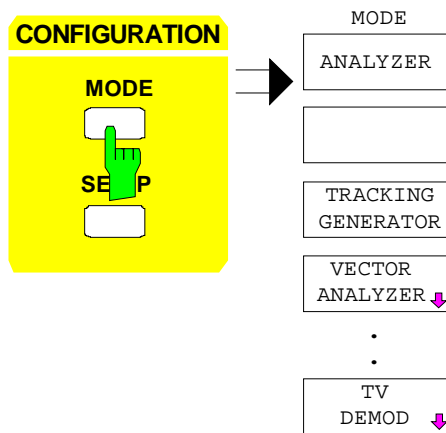

The *MODE* key activates the menu in which the submenu for setting the tracking generator can be selected in addition to different operating modes.

Tracking Generator Settings

SYSTEM MODE menu:

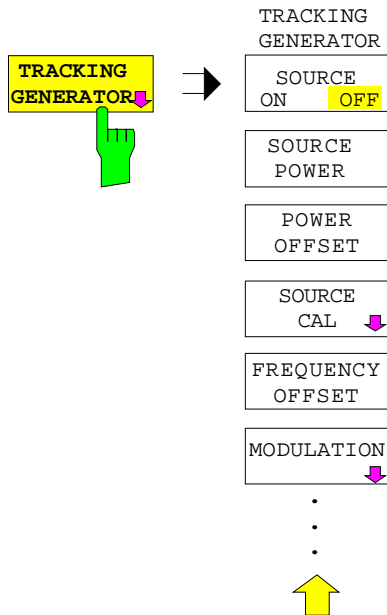

The *TRACKING GENERATOR* softkey opens a menu for setting the functions of the tracking generator.

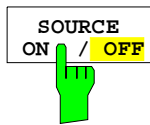

The *SOURCE ON/OFF* softkey switches the tracking generator on or off. Default setting is *OFF*

IEC/IEEE bus command :OUTPut[:STATe] ON | OFF

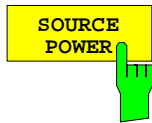

The *SOURCE POWER* softkey activates the entry of the tracking generator output level.

The output level can be set from 0 dBm to -20 dBm in 0.1-dB steps. The setting range is extended to -90 dBm when the tracking generator is equipped with the optional attenuator FSE-B12.

If the tracking generator is off, it is automatically switched on by the *SOURCE PWR* softkey.

Default setting is -20 dBm.

IEC/IEEE bus command

:SOURce:POWer[:LEVel][:IMMediate][:AMPLitude] <num_value>

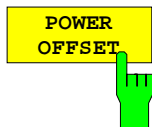

The *POWER OFFSET* softkey activates the entry of a constant level offset of the tracking generator.

With this offset it is possible to consider attenuators or amplifiers at the output connector of the tracking generator during the input or output of output levels, for example.

The permissible setting range is -200 dB to +200 dB in 0.1-dB steps. Positive offsets apply to a subsequent amplifier and negative offsets to an attenuator.

Default setting is 0 dB.

IEC/IEEE bus command

:SOURce:POWer[:LEVel][:IMMediate]:OFFSet <num_value>

Transmission Measurement

In this measurement, the transmission characteristic of a two-port network is measured. The built-in tracking generator is the a signal source. The tracking generator is connected to the input of the DUT. The input of the instrument is connected to the output of the DUT.

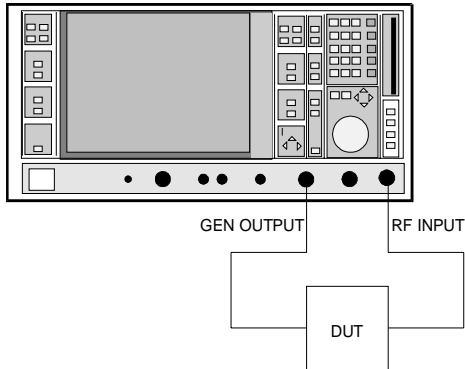
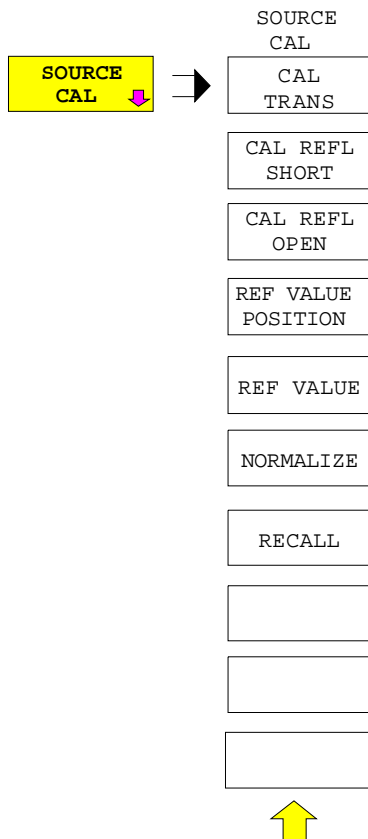

Fig. 4-15 Test setup for reflection measurements

Calibration can be carried out to allow for the effects from the test setup (eg. frequency response of connecting cables).

Calibration of the Transmission Measurement

SYSTEM MODE-TRACKING GENERATOR menu:



The *SOURCE CAL* softkey opens a submenu with the calibration functions for transmission and reflection measurements.

The calibration for the reflection measurement is described of the following sections .

To carry out a calibration for transmission measurements the whole test setup is through-connected (THRU).

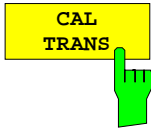

The *CAL TRANS* softkey triggers the calibration for the transmission measurement.

It starts a sweep that records a reference curve. This trace is then used to obtain the differences to the normalized values.

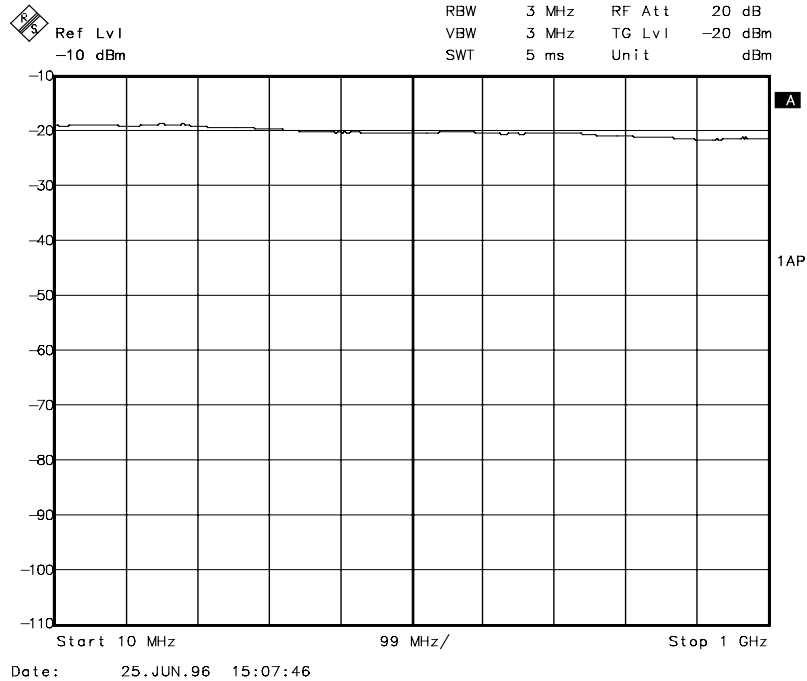
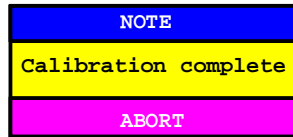

Fig. 4-16 Trace of a transmission calibration procedure

During the calibration sweep the following message is displayed:



After the calibration sweep the following message is displayed:



This message is cleared after approx. 3 seconds.

By saving and recalling the reference data set with the *SAVE* and *RECALL* keys, several calibration datasets can be saved and, then, if necessary, any of these sets can be selected without going through a new calibration routine.

IEC/IEEE bus command

```
:[SENSe:]CORRection:METhod TRANsmission
:[SENSe:]CORRection:COLLect[:ACQuire] THRUgh
```

Normalization

SYSTEM MODE-TRACKING GENERATOR -SOURCE CAL menu:

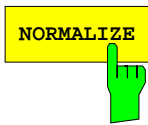

The *NORMALIZE* softkey switches the normalization on or off. The softkey is only enabled if the memory contains a correction trace.

If no reference line is switched on when activating the normalization, all measured values are with reference to the top grid line. The effects of the test setup is corrected in such a way that the measured values are displayed at the top grid margin.

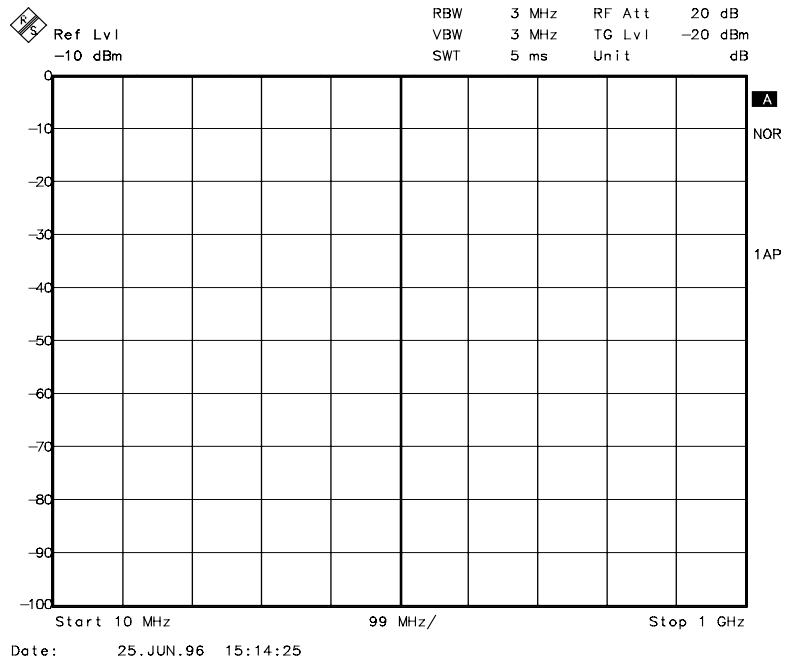

Fig. 4-17 Normalized display

In *SPLIT SCREEN* mode, normalization is switched on in the currently active screen. Different types of normalization can be activated in the two split screens.

Normalization is aborted when the *ANALYZER* operating mode is quit but can be switched on again as long as the reference trace stored in the memory has not been overwritten.

IEC/IEEE bus command :[SENSE:]CORRection[:STATE] ON | OFF

It is now possible to shift the relative reference point within the grid by using the *REF VALUE POSITION* softkey. This means that the trace can be shifted from the upper edge of the grid towards the center of the grid:

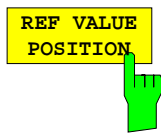

The *REF VALUE POSITION* softkey (reference position) marks a reference position in the active screen at which normalization is performed (difference between trace and reference trace).

If no reference line is switched on, the softkey switches on a reference line and activates the input of its position. The line can be moved within the grid limits.

The reference line is switched off by pressing the softkey again.

The function of the reference line is explained in section "Calibration Method"

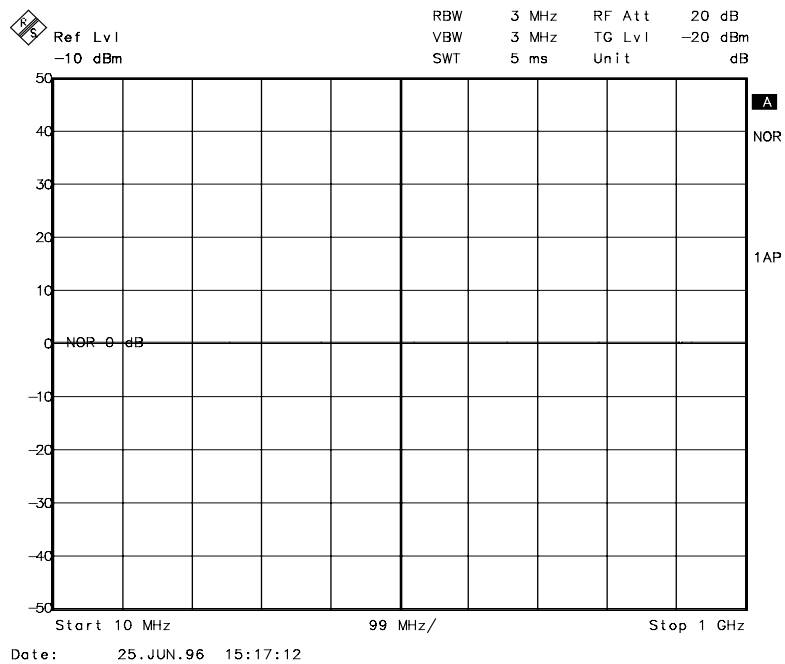

Fig. 4-18 Normalized measurement, shifted with *REF POSITION* 50 %

IEC/IEEE bus command

```
:DISPlay[:WINDow<1|2>]:TRACe<1..4>:Y[:SCALE]:RPosition
0 to 100PCT
```

If, after source calibration, a 10 dB attenuator is inserted into the signal path between DUT and analyzer input, the measurement trace will be moved down by 10 dB. Entering a REF VALUE of -10 dB then moves the reference line down 10 dB. This means that the measured trace and the reference trace coincide again.

After the reference line has been moved by entering a REF VALUE of -10 dB, deviations from the nominal power level can then be displayed with a high resolution (e.g. 1 dB/div). The power is still displayed in absolute values, which means that in the above example 1 dB below the nominal power (reference line) is equivalent to an attenuation of 11 dB.

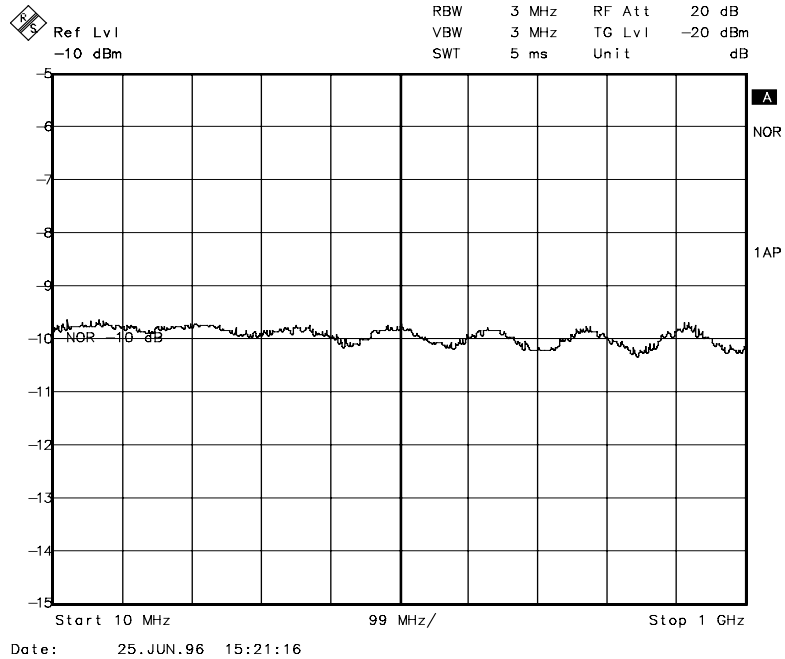
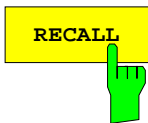

Fig. 4-20 Measurement of a 10dB attenuator pad with 1 dB / Div

IEC/IEEE bus command

```
:DISPlay[:WINDow<1|2>]:TRACe<1...4>:Y[:SCALE]:RVALue
<num_value>
```



The *RECALL* softkey restores the instrument setting that were used during calibration.

This can be useful if the device setting was changed after calibration (eg center frequency setting, frequency deviation, reference level, etc.).

The softkey is only offered if:

- the analyzer mode has been selected
- the memory contains a calibration data set.

```
IEC/IEEE bus command      :[SENSe:]CORREction:RECall
```

Reflection Measurements

Scalar reflection measurements can be carried out with a reflection-coefficient bridge.

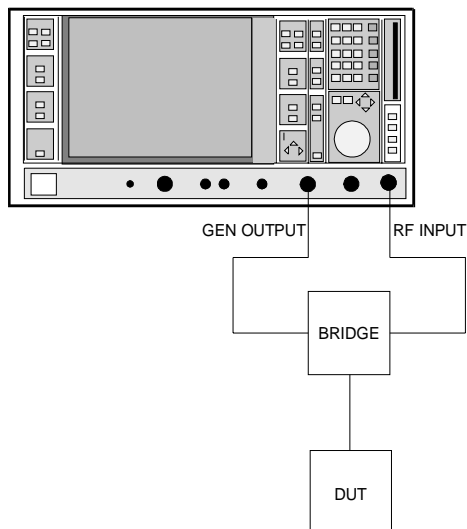

Fig. 4-21 Test setup for reflection measurements

Calibration of Reflection Measurement

This calibration procedure essentially corresponds to that of the transmission measurement.

SYSTEM MODE-TRACKING-SOURCE CAL submenu



The *CAL REFL OPEN* softkey starts the open-circuit calibration.

During calibration the following message is displayed

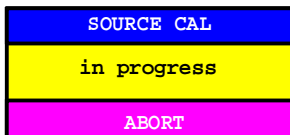

IEC/IEEE bus command

```
:[SENSe:]CORRection:METhod REFLEXion
:[SENSe:]CORRection:COLlect[:ACQuire] OPEN
```



The *CAL REFL SHORT* softkey starts the short-circuit calibration.

If both calibrations (open circuit, short circuit) are carried out, the calibration curve is formed by averaging the two measurements and is stored in the memory. The order of measurements is optional.

The completion of the calibration is indicated by

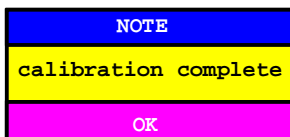

The display is cleared after 3 seconds.

IEC/IEEE bus command

```
:[SENSe:]CORRection:METhod REFLEXion
:[SENSe:]CORRection:COLlect[:ACQuire] THROUGH
```

Calibration Methods

Calibration means forming the difference between current measured values and a reference curve, no matter what the selected measurement type is (transmission/reflection). The hardware settings used for measuring the reference curve are included in the reference dataset.

When normalization is switched on, a wide range of device settings can be changed without aborting normalization. In other words, the number of repeat normalizations is kept to a minimum.

The reference dataset (trace with 500 measured values) is stored internally as a table of 500 points (frequency/level).

Differences in level settings between the reference curve and the current device setting are calculated automatically. For small spans, a linear interpolation is used. If the span is increased, the values at the left or right border of the reference dataset are extrapolated out to the new start or stop frequency; in other words, additional linearly extrapolated values are added to the reference dataset.

An enhancement label is used to mark the different levels of measurement accuracy. This enhancement label is displayed at the right display margin when normalization is switched on and in case of an error from the reference setting. Three accuracy levels are defined:

Table 4-1 Measurement accuracy levels

| Accuracy | Enhancement label | Reason/Limitation |
|----------|-------------------------|---|
| High | NOR | No difference between reference setting and measurement |
| Medium | APP (approximation) | Changes in the following settings: <ul style="list-style-type: none"> • coupling (RBW, VBW, SWT) • reference level, RF attenuation • start or stop frequency • output level of tracking generator • frequency offset of tracking generator • detector (max peak, min peak, sample...) Change of frequency: <ul style="list-style-type: none"> • at most 500 frozen continuation points within the set sweep limits (corresponds to a doubling of the span) |
| - | Abortion of calibration | <ul style="list-style-type: none"> • more than 500 frozen points within the set sweep limits (span doubling) |

Note: At a reference level (REF LEVEL) of -10 dBm and at a tracking generator output level of the same value the instrument operates without a headroom. ie the instrument is in danger of being overloaded by any signal whose amplitude exceeds the reference line. In this case, either the message "OVL" for overload is displayed in the status line or the display range is exceeded (clipping the top of the trace = Overage).

This overload can be avoided as follows:

- Reducing the output level of the tracking generator (SOURCE POWER, SYSTEM-MODE-TRACKING GENERATOR menu)
- Increasing the reference level (REF LEVEL, LEVEL-REF menu)

Frequency-Converting Measurements

For frequency-converting measurements (eg on converters) the tracking generator is able to set a constant frequency offset between the output frequency of the tracking generator and the receive frequency of the instrument. Up to an output frequency of 200 MHz the measurement can be carried out in inverted and normal position.

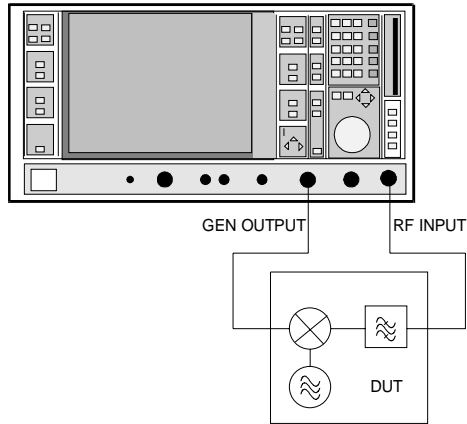
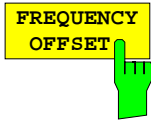

Fig. 4-22 Test setup for frequency-converting measurements

SYSTEM MODE-TRACKING GENERATOR menu:



The *FREQUENCY OFFSET* softkey activates the entry of the frequency offset between the output frequency of the tracking generator and the input frequency of the instrument. The setting range is ± 200 MHz in 1-Hz steps. The default setting is 0 Hz.

If a positive frequency offset is entered, the tracking generator generates an output signal frequency above the receive frequency of the instrument. With a negative frequency offset it generates a signal frequency below the receive frequency of the instrument. The output frequency of the tracking generator is calculated as follows:

Tracking generator frequency = receive frequency + frequency offset.

A frequency offset cannot be entered if an external I/Q or FM modulation is switched on. In this case, the *FREQUENCY OFFSET* softkey is blocked.

IEC/IEEE bus command

```
:SOURce:FREQuency:OFFSet <numeric value>
```

External Modulation of Tracking Generator

SYSTEM MODE-TRACKING GENERATOR menu:

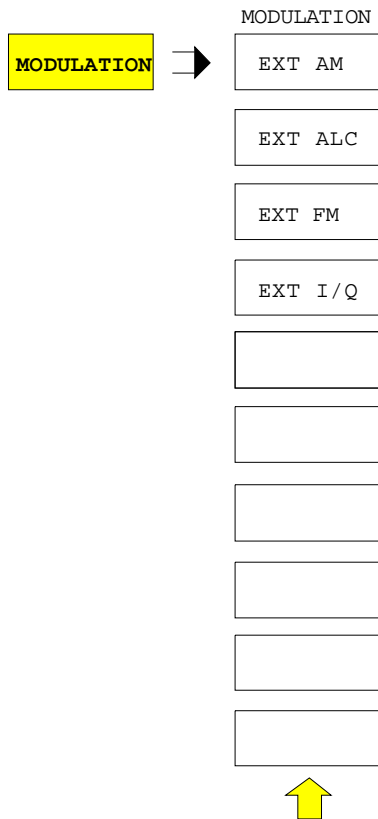

The *MODULATION* softkey opens a submenu for selecting the different modulation types.

The time characteristic of the output signal of the tracking generator can be varied by applying external signals (input voltage range -1 V to +1 V).

The functions for amplitude and frequency modulation and for external level control are always available.

The function IQ modulation is only available in models of tracking generators that are equipped with the IQ modulator (FSE-B9 and FSE-B11).

Two BNC connectors at the rear panel are available as signal inputs. Their function changes depending on selected modulation type:

TG-INPUT I / AM / ALC and

TG-INPUT Q / FM

The types of modulation can partly be combined with each other and with the frequency offset function. The following table shows which modulation types can be selected simultaneously and which can be combined with the frequency offset function.

Table 4-2 Simultaneous modulation types (tracking generator)

| Modulation | Frequency offset | EXT AM | EXT ALC | EXT FM | EXT I/Q |
|------------------|------------------|--------|---------|--------|---------|
| Frequency offset | | • | • | • | |
| EXT AM | • | | | • | |
| EXT ALC | • | | | | |
| EXT FM | • | • | | | |
| EXT I/Q | | | | | |

- modulations can be combined

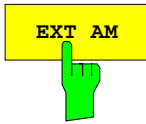

The *EXT AM* softkey activates AM modulation of the tracking generator output signal.

The modulation signal is connected to the *TG-INPUT AM* connector. The maximum possible modulation depth is 80% which corresponds to an input voltage of 0.8 V.

Switching on external AM deactivates the following functions:

- active external level control
- active I/Q modulation.

IEC/IEEE bus command : `SOURce:AM:STATe ON | OFF`

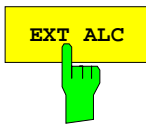

The *EXT ALC* softkey activates the external level control.

In case of external level control the output level of the tracking generator is determined from the signal of an external detector. The external detector has to supply a negative voltage in the range of -0.1 to -1 V which is applied to the *TG-INPUT ALC* connector. The setting of the output level is the same as that of the internal level control but the output level depends on the external detector.

Switching on an external level control deactivates the following functions:

- active external AM
- active I/Q modulation.

IEC/IEEE bus command : `SOURce:POWer:ALC:SOURce INT | EXT`



The *EXT FM* softkey activates FM modulation of the tracking generator output signal.

The modulation frequency range is 1 kHz to 100 kHz, the deviation is approx. 1 MHz at an input voltage of 1 V.

The modulation signal is connected to the *TG-INPUT FM* connector.

Switching on external FM deactivates the following function:

- active I/Q modulation.

IEC/IEEE bus command : `SOURce:FM:STATe ON | OFF`

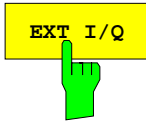

The *EXT I/Q* softkey is only offered with I/Q modulator option built-in. It activates external I/Q modulation of the tracking generator (FSE-B9 and FSE B-11).

The modulation signals are connected to the two input connectors *TG-INPUT IN* and *TG-INPUT Q* at the rear of the unit. The input voltage range is ± 1 V into 50Ω .

Switching on external I/Q modulation deactivates the following functions:

- active external AM
- active external level control
- active external FM or
- a level offset.

Functional description of quadrature modulator:

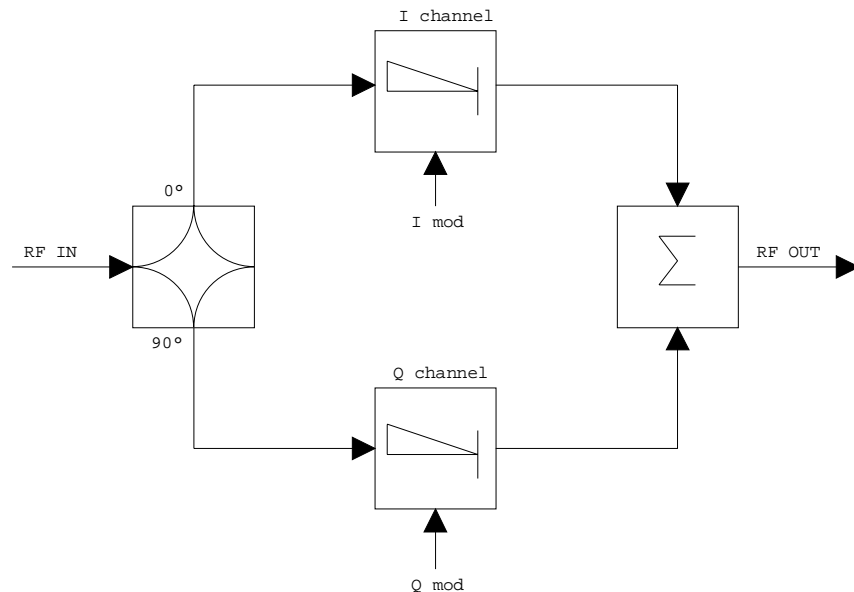

Fig. 4-23 I/Q modulation

I/Q modulation is performed by means of the built-in quadrature modulator. The RF signal is divided into the two orthogonal components, I and Q (inphase and quadrature phase). Amplitude and phase are controlled in each path by the I and Q modulation signal. Adding the two components generates an RF output signal whose amplitude and phase can be controlled.

IEC/IEEE bus command :SOURCE:DM:STATE ON | OFF

Option FSE-B3 –TV Demodulator

With the Option TV Demodulator FSE-B3, the FSE permits to demodulate TV signals and synchronize the trigger signal with the TV signal.

The demodulated TV signal is available at the rear panel of the FSE as CCVS signal for operation of a TV monitor. The possible settings of video polarity and offset between picture and sound carrier permit to cover all known standards.

In order to represent particular sections of the TV signal in the time domain, the FSE derives different trigger signals from the video signal. It is possible to trigger on the frame repetition and on each individual line of the TV signal.

Configuration of the TV Demodulator

The TV standard is preset using the MODE menu of the FSE. If the Option TV Demodulator is installed, the MODE menu is supplemented by the softkey *TV DEMOD*. When the demodulation of TV signals is switched on using *TV DEMOD*, the FSE automatically changes to the time domain (zero-span mode). The default settings following preset of the FSE are sweep time 100 μ s, linear level display (*LIN %*) and 5 MHz IF bandwidth. Measurement of the spectrum is still possible.

Menu: *CONFIGURATION MODE*

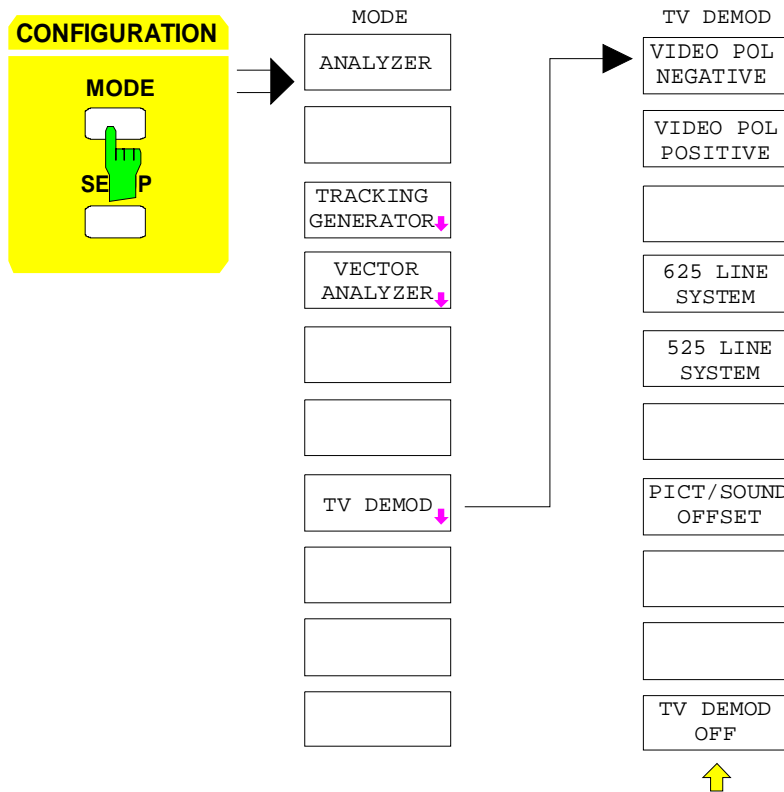

The softkey *TV DEMOD* switches on the TV demodulator and simultaneously opens a submenu in which the parameters of the video signal can be set. If the TV demodulator is switched on, the softkey is backlit. The other available modes are switched off.



The soft keys *VIDEO POL NEGATIVE* and *VIDEO POL POSITIVE* determine the polarity of the video signal. The two softkeys are selector switches.

Positive video polarity is to be selected e.g. for standard L signals, negative video polarity for signals according to the standards B/G/I/M (color standard PAL or NTSC). Default setting is *VIDEO POL NEGATIVE*.

IEC/IEEE bus command

```
:TRIGger<1|2>[:SEquence]:VIDeo:SSIGnal:POLarity POS|NEG
```

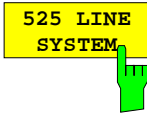
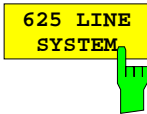

The soft keys *625 LINE SYSTEM* and *525 LINE SYSTEM* permit to select the line system to be used. The two softkeys are selector switches.

Default setting is *625 LINE SYSTEM*.

IEC/IEEE bus command

```
:TRIGger<1|2>[:SEquence]:VIDeo:FORMat:LPFRame 625|525
```



The soft key *PICT/SOUND OFFSET* is used to set the offset between the demodulated picture carrier and the test channel of the FSE.

The setting range is 0 to 6.5 MHz. The frequency resolution for the offset is 25 kHz.

No offset is set in the default setting.

With the offset 0 MHz, the FSE measures at the frequency of the picture carrier. This setting permits to measure the time characteristic of the video signal.

If an appropriate offset between picture and sound carrier is set, the picture can be seen on a connected TV monitor and the sound simultaneously monitored via the AF demodulator. To this end, the FSE needs to be tuned to the frequency of the sound carrier.

The picture/sound carrier offsets for the most commonly used TV standards are as follows:

| | |
|--------------------|---------|
| Standard B/G and L | 5.5 MHz |
| Standard M and N | 4.5 MHz |
| Standard I | 6 MHz |

IEC/IEEE bus command `<:SENSe1|2>:TV:POFFset 0 ... 6.5 MHz`

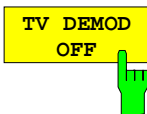

The soft key *TV DEMOD OFF* switches off the TV demodulator.

IEC/IEEE bus command `<:SENSe1|2>:TV[:STATe] ON | OFF`

Triggering on TV Signals

If the Option TV Demodulator is installed, the trigger menu is supplemented by the TV trigger (softkey *TV*) and the settings for the trigger condition (*TV TRIGGER SETTING*).

Menu: SWEEP TRIGGER

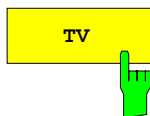
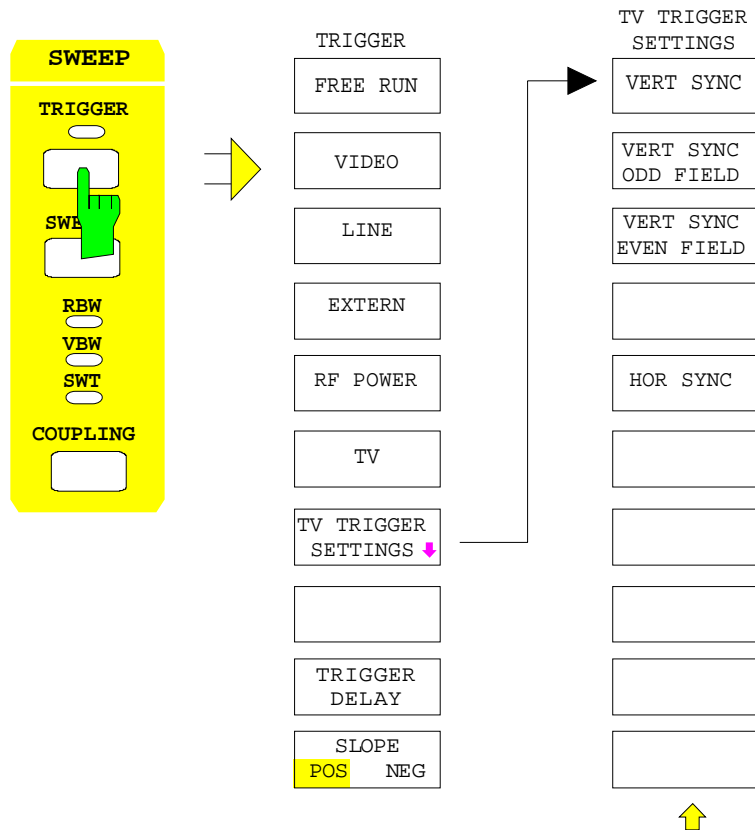

The softkey *TV* sets the trigger of the FSE to a TV signal according to the trigger condition selected under *TV TRIGGER SETTINGS*. The TV trigger can be set as an alternative to the remaining trigger sources.

IEC/IEEE bus command

```
:TRIGger<1|2>[:SEquence]:SOURce TV
```



The softkey *TV TRIGGER SETTINGS* opens a submenu for the TV trigger settings.

The trigger source can be selected:

It is possible to trigger on the frame repetition (*VERT SYNC*), on a field (*VERT SYNC EVEN FIELD* or *VERT SYNC ODD FIELD*) or on any line of the TV picture (*HOR SYNC SIGNAL*).

IEC/IEEE bus command

```
:TRIGger<1|2>[:SEquence]:VIDeo:FIEld:SElect ALL
```

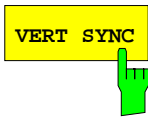

The softkey *VERT SYNC* sets the trigger to the vertical sync signal. It is possible to trigger on the frame repetition without a differentiation being made between the two fields.

IEC/IEEE bus command

```
:TRIGger<1|2>[:SEQuence]:VIDeo:FIELD:SElect ALL
```



The softkeys *VERT SYNC ODD FIELD* or *VERT SYNC EVEN FIELD* set the trigger to the vertical sync signal of the first or second field.

IEC/IEEE bus command

```
:TRIGger<1|2>[:SEQuence]:VIDeo:FIELD:SElect ODD | EVEN
```

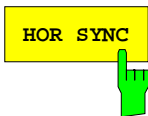

The softkey *HOR SYNC* sets the trigger to the horizontal sync signal. It activates line input.

The trigger can be set to any line. Depending on the setting of the line systems, lines 1 to 525 or 625 are possible. If a higher line number is entered, the trigger is set to the highest possible number.

In order to trigger on test line 17 according to CCIR 473-4, for example, the line value is to be set to 17. This is also the default setting after switching on of the TV demodulator.

IEC/IEEE bus command

```
:TRIGger<1|2>[:SEQuence]:VIDeo:LINE:NUMBer <num_value>
```

10 Index

Note:

- The softkeys are listed alphabetically under the keyword "Softkey".
- For each softkey, the page in chapter 6 containing the description of the corresponding remote command is quoted in addition.
- The assignment between IEEE-bus commands and softkeys is described in Chapter 6, Section "Table of Softkeys with IEC/IEEE-Bus Command Assignment".
- Chapter 6 contains an alphabetical list of all IEEE-bus commands

A

| | |
|--|------------|
| Abort | |
| hardcopy | 4.51, 4.52 |
| macro | 4.49 |
| ACP measurement | 4.114 |
| absolute/relative | 4.119 |
| bandwidth | 4.116 |
| channel spacing | 4.117 |
| channels | 4.114 |
| filter | 4.116 |
| limits | 4.117 |
| standard | 4.115 |
| Addressed command | 8.5 |
| Adjacent channel power measurement | 4.114 |
| Administrator identification | 1.23 |
| Alphanumeric parameter | |
| editing | 3.17 |
| AM modulation | 4.204 |
| Analog trace | 4.165 |
| Ascii # | 5.14 |
| Attenuation | 4.100 |
| Attenuator (tracking generator) | 4.193 |
| AUI connector | 1.45, 1.74 |
| Autopeak detector | 4.163 |
| Average | 4.158 |
| continuous sweep | 4.159 |
| signal per sweep | 4.139 |
| single sweep | 4.159 |
| summary markers | 4.140 |
| sweep count | 4.158 |
| Average detector | 4.164 |
| Axis labelling | 3.7 |

B

| | |
|-------------------------|------------|
| Bandwidth | |
| channel | 4.116 |
| occupied | 4.124 |
| resolution | 4.171 |
| video | 4.172 |
| Beeper | 4.40 |
| Block data | 5.14 |
| BNC connector | 1.44, 1.73 |
| Boolean parameter | 5.13 |

C

| | |
|-------------------|-------|
| Calibration | 4.9 |
| method | 4.201 |

| | |
|--------------------------------|------------|
| CCVS signal | 4.206 |
| CD-ROM installation | 1.36 |
| Center frequency | 4.87 |
| Channel | |
| bandwidth | 4.116 |
| power measurement | 4.118 |
| power, absolute/relative | 4.119 |
| spacing | 4.117 |
| Characters, special | 6.2 |
| Clear/Write | 4.157 |
| Clock | 4.39 |
| Colon | 5.14 |
| COM1/2 interface | 4.36, 4.42 |
| Comma | 5.14 |
| Command | |
| # | 5.14 |
| addressed | 8.5 |
| colon | 5.14 |
| comma | 5.14 |
| header | 5.10 |
| line | 5.12 |
| long form | 5.11 |
| overlapping execution | 5.17 |
| query | 5.12 |
| question mark | 5.12, 5.14 |
| quotation mark | 5.14 |
| recognition | 5.16 |
| sequence | 5.17 |
| short form | 5.11 |
| structure | 5.9 |
| suffix | 5.11 |
| synchronization | 5.17 |
| syntax elements | 5.14 |
| universal | 8.5 |
| white space | 5.14 |
| Common commands | 6.4 |
| CONDition register part | 5.19 |
| Configuration | 4.20 |
| recall | 4.75 |
| reset | 4.2 |
| save | 4.66 |
| Copy | |
| file | 4.69 |
| limit line | 4.150 |
| trace | 4.160 |
| Coupling | 4.170 |
| default settings | 4.173 |
| define | 4.176 |
| Cursor keys | 3.14 |

D

| | |
|--------------------------|----------|
| D Lines | 4.144 |
| Data set | |
| creation | 4.75 |
| partial | 4.73 |
| recall | 4.75 |
| save | 4.70 |
| Date | 4.45 |
| dB*/MHz | 4.97 |
| dB μ A/MHz | 4.97 |
| dB μ A/mMHz | 4.97 |
| dB μ V/MHz | 4.97 |
| dB μ V/mMHz | 4.97 |
| dBmV/MHz | 4.97 |
| DCL | 5.16 |
| Default | |
| commands | 6.1 |
| instrument settings | 4.2 |
| Delete | |
| file | 4.69 |
| line of transducer table | 4.26 |
| macro | 4.83 |
| message | 4.16 |
| transducer factor/set | 4.23 |
| Delta marker | 4.128 |
| step size | 4.132 |
| Demodulation | 4.109 |
| Detector | |
| auto select | 4.163 |
| autopeak | 4.163 |
| average | 4.164 |
| max peak | 4.163 |
| min peak | 4.163 |
| RMS | 4.164 |
| sample | 4.164 |
| Device | |
| reset (hardcopy) | 4.64 |
| reset (overall) | 4.2 |
| status | 4.13 |
| DIFOVL | 3.4 |
| Directory | |
| create | 4.69 |
| rename | 4.69 |
| Disable | |
| front panel | 3.19 |
| keyboard | 3.19 |
| Disk formatting | 4.69 |
| Display | |
| configuration | 4.3 |
| energy-saving | 1.21 |
| mean value | 4.139 |
| rms value | 4.139 |
| Display mode | |
| full screen | 3.9, 4.4 |
| split screen | 3.8, 4.4 |
| Double dagger | 5.14 |
| Driver | |
| installation | 1.75 |
| NDIS | 1.76 |
| ODI | 1.75 |
| packet | 1.78 |
| printer | 1.28 |
| software | 1.39 |

E

| | |
|-------------------------|------|
| Electrostatic discharge | 1.18 |
| ENABle register part | 5.19 |
| Energy saving mode | 1.21 |

| | |
|------------------------------------|------------|
| Enhancement labels | 3.6 |
| Entry | |
| abortion | 3.16 |
| alphanumeric parameters | 3.17 |
| mouse control | 3.22 |
| numeric parameter | 3.16 |
| table | 3.18 |
| termination | 3.16 |
| window | 3.15 |
| Error messages | 9.1 |
| Error-queue query | 5.33 |
| ESE (event status enable register) | 5.22 |
| ESR (event status register) | 5.22 |
| Ethernet Adapter | 1.44, 1.73 |
| EVENT register part | 5.19 |
| Event status enable register (ESE) | 5.22 |
| Event status register (ESR) | 5.22 |
| EXT ALC modulation | 4.204 |
| Ext Trig/Gate input | 8.24 |
| External noise source | 4.32 |
| ExtRef | 3.4 |

F

| | |
|--------------------|------------------|
| FFT filter | 4.174 |
| File | |
| copy | 4.69 |
| delete | 4.69 |
| rename | 4.69 |
| sort | 4.69 |
| Firmware | |
| options (enabling) | 4.31 |
| options (info) | 4.14 |
| update | 1.38, 1.70, 4.47 |
| version | 4.13 |
| FM modulation | 4.204 |
| Frequency | |
| axis labelling | 3.7 |
| counter | 4.111 |
| line | 4.143 |
| measurement window | 4.84 |
| offset | 4.88 |
| start | 4.84 |
| stop | 4.86 |
| zoom | 4.93 |
| Front panel | |
| disable | 3.19 |
| keyboard emulation | 3.21, 3.23 |
| FTP operation | 1.55, 1.85 |
| Full screen | 3.9, 4.4 |
| Function test | 1.22 |
| Fuse | 1.19, 1.57 |

G

| | |
|-----------------------------|------|
| GET (Group Execute Trigger) | 5.16 |
| GPIB | |
| address | 4.34 |
| interface | 8.2 |

H

| | |
|-----------|------------|
| Handshake | 8.8 |
| Hardcopy | |
| abort | 4.51, 4.52 |
| comments | 4.57 |
| format | 4.59, 4.63 |
| items | 4.55 |

| | |
|-----------------------------|------------|
| output device..... | 4.60 |
| position..... | 4.56 |
| printer..... | 4.58 |
| settings..... | 4.54 |
| start..... | 4.50, 4.52 |
| Hardware | |
| configuration..... | 4.14 |
| indication of settings..... | 3.5 |
| installed options..... | 4.14 |
| Header..... | 5.10 |
| Help line editor..... | 3.17 |

I

| | |
|----------------------------|------------|
| I/Q modulation..... | 4.205 |
| IEC/IEEE-bus | |
| address..... | 4.34, 4.40 |
| interface..... | 8.2 |
| output device address..... | 4.63 |
| I/OVLD..... | 3.4 |
| Indication | |
| hardware settings..... | 3.5 |
| instrument settings..... | 3.6 |
| marker information..... | 3.5 |
| screen..... | 3.4 |
| Input | |
| attenuator..... | 4.100 |
| Ext Trig/Gate..... | 8.24 |
| external reference..... | 8.24 |
| Input buffer..... | 5.15 |
| Installation | |
| CD-ROM..... | 1.36 |
| firmware update..... | 1.38, 4.47 |
| keyboard..... | 1.25 |
| monitor..... | 1.26 |
| mouse..... | 1.24 |
| network printer..... | 1.34 |
| printer..... | 1.28 |
| rack..... | 1.19 |
| Windows NT software..... | 1.39 |
| Instrument functions..... | 4.1 |
| Instrument settings | |
| indication..... | 3.6 |
| power up..... | 4.76 |
| preset..... | 4.2, 4.76 |
| Interface | |
| IEC/IEEE-bus..... | 8.2 |
| printer..... | 8.22 |
| RS-232-C..... | 8.6 |
| RSIB..... | 8.10 |
| Interrupt..... | 5.32 |
| IST flag..... | 5.22 |

K

| | |
|---------------|-------------|
| KERMIT..... | 1.86 |
| Key | |
| CAL..... | 4.9 |
| CENTER..... | 4.87, 6.193 |
| CONFIG..... | 4.68 |
| COUPLING..... | 4.170 |
| cursor..... | 3.14 |
| D LINES..... | 4.143 |
| DELTA..... | 4.128 |
| DISPLAY..... | 4.3 |
| HOLD..... | 3.19 |
| INFO..... | 4.13 |
| INPUT..... | 4.100 |
| LIMITS..... | 4.147 |

| | |
|------------------------|-------------------|
| LOCAL..... | 4.49 |
| MENU..... | 3.12 |
| MKR..... | 4.141 |
| MODE..... | 4.18 |
| NORMAL..... | 4.105 |
| numeric keypad..... | 3.13 |
| PRESET..... | 4.2, 6.231 |
| RANGE..... | 4.98 |
| RECALL..... | 4.75 |
| REF..... | 4.94 |
| roll-key..... | 3.14 |
| SAVE..... | 4.70 |
| SEARCH..... | 4.133 |
| SETTINGS..... | 4.54 |
| SETUP..... | 4.20 |
| SPAN..... | 4.91 |
| START (frequency)..... | 4.84 |
| START (hardcopy)..... | 4.50, 4.52, 6.122 |
| STEP..... | 3.20 |
| STOP..... | 4.86 |
| SWEEP..... | 4.180 |
| TRACE1 to 4..... | 4.156 |
| TRIGGER..... | 4.178 |
| USER..... | 4.80 |
| Keyboard | |
| configuration..... | 4.47 |
| connection..... | 1.25, 1.62 |
| connector..... | 8.25 |
| disable..... | 3.19 |
| external..... | 3.21 |

L

| | |
|-----------------------------------|-------|
| Level | |
| attenuation..... | 4.100 |
| control, external..... | 4.204 |
| line..... | 4.145 |
| maximum..... | 4.95 |
| mixer..... | 4.101 |
| offset (tracking generator)..... | 4.193 |
| range..... | 4.98 |
| reference..... | 4.94 |
| unit..... | 4.96 |
| LF demodulation..... | 4.109 |
| Limit line..... | 4.147 |
| copy..... | 4.150 |
| delete..... | 4.150 |
| edit..... | 4.151 |
| save..... | 4.155 |
| select..... | 4.148 |
| shift..... | 4.155 |
| value..... | 4.154 |
| Line | |
| display 1,2..... | 4.145 |
| frequency 1, 2..... | 4.145 |
| limit..... | 4.148 |
| reference..... | 4.145 |
| threshold..... | 4.145 |
| time 1, 2..... | 4.146 |
| LO Lvd..... | 3.4 |
| LO Lvl..... | 3.4 |
| LO unl..... | 3.4 |
| Login/logout (NT controller)..... | 1.23 |
| Lower case..... | 6.2 |
| LPT interface..... | 8.22 |

- M**
- Macro
 - abort..... 4.49
 - definition..... 4.82
 - start..... 4.80
 - Maintenance..... 8.1
 - Manual operation..... 3.1
 - return to..... 4.49, 5.3
 - Marker..... 4.105
 - center..... 4.141
 - delta..... 4.128
 - demodulation..... 4.110
 - indication..... 3.5
 - info..... 4.109
 - n-dB-down..... 4.137
 - normal..... 4.105
 - peak..... 4.134, 4.141
 - search..... 4.133
 - search limit..... 4.137
 - signal track..... 4.108
 - step size..... 4.127
 - zoom..... 4.109
 - Max hold..... 4.159
 - Max peak detector..... 4.163
 - Mean power (GSM burst)..... 4.139
 - Measurement
 - frequency-converting..... 4.202
 - recall..... 4.75
 - save..... 4.66
 - transmission..... 4.194
 - window..... 4.3
 - Measurement converters..... 4.20
 - connector..... 8.22, 8.23
 - Memory
 - battery-backed-up..... 1.21
 - battery-powered..... 1.58
 - configuration..... 4.68
 - Menu overview..... 3.24
 - Menu switching..... 3.11
 - MICROSOFT NET operation..... 1.49, 1.83
 - Min hold..... 4.160
 - Min peak detector..... 4.163
 - Minimum search..... 4.134
 - Mixer level..... 4.101
 - Mode..... 4.18
 - signal analysis..... 4.84
 - tracking generator..... 4.192
 - Modification level of modules..... 4.14
 - Modulation
 - AM..... 4.204
 - EXT ALC..... 4.204
 - FM..... 4.204
 - I/Q..... 4.205
 - Modulation filter..... 4.116
 - Monitor
 - connecting..... 4.39
 - connection..... 1.26
 - connector..... 8.25
 - Mouse
 - configuration..... 4.46
 - connection..... 1.24, 1.58
 - connector..... 8.25
 - control..... 3.22
- N**
- NDIS (driver)..... 1.76
 - Network drivers..... 1.75
 - Network operating system
 - FTP..... 1.55, 1.85
 - MICROSOFT NET..... 1.49, 1.80
 - NOVELL NETWARE..... 1.49, 1.78, 1.81
 - TCP/IP..... 1.54, 1.85
 - Network printer connection..... 1.34
 - Noise power density measurement..... 4.112
 - Noise source, external..... 4.32
 - NOVELL NETWARE operation..... 1.49, 1.81
 - NT controller..... 1.23
 - NTRansition register part..... 5.19
 - Numeric keypad..... 3.13
 - Numeric parameter
 - editing..... 3.16
 - Numerical values (command)..... 5.13
- O**
- OCXO..... 3.4
 - ODI drivers..... 1.75
 - Offset frequency..... 4.88
 - Operating mode
 - signal analysis..... 4.84
 - tracking generator..... 4.192
 - Option
 - FSE-B3 - TV Demodulator..... 4.206
 - FSE-B5 - FFT Filter..... 1.42, 1.43
 - FSE-B8/B9/B10/B11 - Tracking Generator..... 4.192
 - FSE-B13 - 1 dB Attenuator..... 4.102, 4.103
 - FSE-B16 - Ethernet Adapter..... 1.44, 1.73
 - FSE-B17 - Second IEC/IEEE bus interface..... 1.40
 - Output
 - AF..... 8.22, 8.24
 - buffer..... 5.17
 - IF..... 8.24
 - level (tracking generator)..... 4.193
 - noise source control..... 8.24
 - reference..... 8.24
 - sweep..... 8.24
 - video out..... 8.24
 - Output device
 - formfeed..... 4.64
 - paperfeed..... 4.65
 - OVLD..... 3.4
- P**
- Packet driver..... 1.78
 - Parallel poll..... 5.33
 - Parallel poll enable register (PPE)..... 5.22
 - Parameter
 - block data..... 5.14
 - boolean..... 5.13
 - numerical values..... 5.13
 - string..... 5.14
 - text..... 5.14
 - Password
 - service function..... 4.33
 - Windows NT..... 1.23
 - Path..... 4.68
 - Peak
 - detector..... 4.161
 - excursion..... 4.135
 - search..... 4.134
 - Plotter connection..... 1.66
 - Power mean..... 4.139
 - Power measurement
 - adjacent channel..... 4.122
 - automatic optimisation of settings..... 4.125
 - bandwidth, occupied..... 4.124

channel..... 4.118
channel configuration 4.113
signal/noise 4.120
PPE (parallel poll enable register)..... 5.22
Preset..... 4.2
Pre-trigger..... 4.190
Printer connection..... 1.28, 1.66, 8.22
Printing
 abort..... 4.51
 Configuration..... 4.54
 start..... 4.50
Probe Code connector..... 8.23
Probe Power connector 8.23
PTRansition register part..... 5.19

Q

Quasi analog display 4.165
Query..... 5.12, 5.33
Question mark 5.12, 5.14
Quotation mark 5.14

R

Rack installation 1.19, 1.56
Range
 level..... 4.98
Recall data set..... 4.75
Recording the correction data 4.9
Reference
 dataset (tracking generator)..... 4.201
 external 4.31
 line 4.145
Reference level..... 4.94
 offset 4.95
Remote control
 basics..... 5.1
 IEC-bus 5.3
 indication 4.49, 5.2
 RS-232-C 5.4
 RSIB..... 5.6, 8.10
 switch over 5.2
Rename
 directory 4.69
 file 4.69
Reset
 device..... 4.2
 status reporting system 5.34
Resolution bandwidth 4.171
RF attenuation 4.100
 auto 4.101
 auto low distortion 4.101
 auto low noise 4.101
RF input..... 4.100
RJ45 (star topology) 1.45, 1.74
RMS detector..... 4.164
RMS value (summary marker) 4.139
Roll-key 3.14
RS-232-C
 interface 8.6
 interface functions 8.7
 transmission parameters 8.7
RSIB interface 8.10

S

Sample detector 4.164
Save
 configuration 4.66
 data set..... 4.70
 limit line..... 4.155
 measurement..... 4.66
SCPI
 conformance information..... 6.1
 introduction 5.9
Screen..... 3.2, 4.4
 full screen 3.9
 indications..... 3.4
 split screen..... 3.9
Search
 limit 4.137
 minimum 4.134
 peak..... 4.134
Self test..... 4.15
Serial interface
 configuration 4.36, 4.42
Serial poll 5.32
Service functions..... 4.32
Service Pack 1.39
Service request (SRQ) 5.21, 5.32
 indication..... 4.49
Service request enable register (SRE) 5.21
Setup 4.20
 general..... 4.34, 4.40
Softkey
 % POWER BANDWIDTH..... 4.117, 6.205
 ACP STANDARD..... 4.115, 6.52
 ACTIVE MKR / DELTA 4.134
 ACTIVE SCREEN A/B 4.4
 ADJACENT CHAN POWER..... 4.122, 6.50, 6.51
 ADJUST CP SETTINGS 4.125, 6.205
 ADJUST TO TRACE..... 4.165, 4.166
 ALL DELTA OFF..... 4.129, 6.10
 ALL MARKER OFF..... 4.108, 6.39
 ALL SUM MKR OFF 4.140, 6.59
 AM 4.109, 4.110, 6.45
 AMPERE..... 4.98, 6.62
 ANALOG TR ON/OFF..... 4.165, 6.99
 ANALYZER..... 4.18, 4.84, 6.130
 APPEND NEW..... 4.167, 6.118
 area 3.10
 ASCII COMMENT 4.168, 6.118
 ASCII CONFIG..... 4.167
 ASCII EXPORT..... 4.167, 6.138
 ATT SWITCHES 4.17, 6.90
 ATTEN AUTO LOW DIST 4.101, 6.127
 ATTEN AUTO LOW NOISE 4.101, 6.127
 ATTEN AUTO NORMAL 4.101, 6.127
 ATTEN STEP 1dB/10dB 4.102, 4.104, 6.128
 AUTO 0.1 * RBW 4.89, 6.194
 AUTO 0.1 * SPAN 4.89, 6.194
 AUTO 0.5 * RBW 4.90, 6.194
 AUTO 0.5 * SPAN 4.90, 6.194
 AUTO RECALL 4.76, 6.136
 AUTO SELECT 4.163, 6.181
 AUTO x * RBW 4.90, 6.194
 AUTO x * SPAN..... 4.90, 6.194
 AVERAGE 4.158, 6.98, 6.166
 AVERAGE ON/OFF 4.140, 6.59
 BASELINE CLIPPING..... 4.146, 6.16
 BLANK..... 4.158, 6.99
 BRIGHTNESS..... 4.6, 6.93
 C/N 4.120, 6.50, 6.51
 C/No 4.120, 6.50, 6.51
 CAL CORR ON/OFF..... 4.11, 6.64
 CAL I/Q..... 4.10, 6.63

| | | | |
|--------------------------------|--------------------------------|-------------------------------------|---------------------------------------|
| CAL LO SUPP..... | 4.10, 6.64 | DISPLAY COMMENT | 4.7, 6.94 |
| CAL LOG..... | 4.10, 6.64 | DISPLAY LINE 1/2..... | 4.145, 6.15 |
| CAL REFL OPEN..... | 4.200, 6.172 | EDIT ACP LIMITS..... | 4.117, 6.33, 6.34, 6.35 |
| CAL REFL SHORT..... | 4.200, 6.172 | EDIT COMMENT | 4.71, 6.142 |
| CAL RES BW..... | 4.10, 6.63 | EDIT LIMIT LINE..... | 4.152, 6.22 |
| CAL RESULTS..... | 4.12 | EDIT NAME | 4.71, 4.76, 6.135, 6.137 |
| CAL SHORT..... | 4.10, 6.64 | EDIT PATH..... | 4.68, 4.71, 4.76, 4.167, 6.133, 6.137 |
| CAL TOTAL..... | 4.10, 6.63 | EDIT TRD FACTOR..... | 4.24, 6.174 |
| CAL TRANS..... | 4.195, 6.172 | EDIT TRD SET | 4.27, 6.176 |
| CENTER FIXED..... | 4.85, 4.86, 4.92, 6.194, 6.195 | ENABLE ALL ITEMS | 4.74, 4.79, 6.141 |
| CENTER MANUAL..... | 4.87, 6.193 | ENABLE DEV1 / DEV2..... | 4.59, 4.65 |
| CH FILTER ON/OFF..... | 4.116, 6.52 | ENABLE OPTION..... | 4.31 |
| CHANNEL BANDWIDTH..... | 4.116, 6.204 | ENTER PASSWORD..... | 4.33, 6.230 |
| CHANNEL POWER..... | 4.118, 6.50, 6.51 | ENTER TEXT | 4.57 |
| CHANNEL SPACING..... | 4.117, 6.203 | EXCLUDE LO ON/OFF..... | 4.135, 6.40 |
| CLEAR ALL MESSAGES..... | 4.16 | EXECUTE TESTS | 4.15, 6.7 |
| CLEAR MESSAGE..... | 4.16, 6.230 | EXT ALC..... | 4.204, 6.213 |
| CLEAR/WRITE..... | 4.157, 6.98 | EXT AM..... | 4.204, 6.212 |
| COLOR ON/ OFF..... | 4.55, 6.121 | EXT FM | 4.204, 6.213 |
| COM PORT 1/2..... | 4.36, 4.42, 6.227, 6.228 | EXT I/Q..... | 4.205, 6.212 |
| COMMENT SCREEN A/B..... | 4.57, 6.123 | EXT REF FREQUENCY | 4.31, 6.206 |
| CONFIG..... | 4.167 | EXTERN (trigger)..... | 4.179, 6.235, 6.236 |
| CONFIG DISPLAY..... | 4.6 | EXTERNAL KEYBOARD | 4.47 |
| CONTINUOUS SWEEP | 4.180, 6.125 | FIRMWARE UPDATE..... | 4.47, 6.230 |
| COPY..... | 4.69, 6.134 | FIRMWARE VERSION | 4.13, 6.5 |
| COPY (TRACE)..... | 4.160, 6.234 | FM..... | 4.109, 4.110, 6.45 |
| COPY LIMIT LINE..... | 4.150, 6.28 | FORMAT DISK | 4.69, 6.135 |
| COPY SCREEN..... | 4.55, 6.122 | FREE RUN | 4.178, 6.235 |
| COPY TABLE..... | 4.55, 6.123 | FREQ AXIS LIN/LOG..... | 4.85, 6.210 |
| COPY TRACE..... | 4.55, 6.124 | FREQUENCY LINE 1/2..... | 4.145, 6.17 |
| COUNTER RESOL..... | 4.112, 6.40 | FREQUENCY OFFSET | 4.88, 4.202, 6.196 |
| COUPLING CONTROL | 4.5, 6.131 | FREQUENCY ON/OFF..... | 4.7, 6.92 |
| COUPLING DEFAULT | 4.173, 6.168, 6.207 | FULL PAGE..... | 4.56, 6.124 |
| COUPLING RATIO..... | 4.176 | FULL SCREEN..... | 4.4, 6.92 |
| CP/ACP ABS/REL..... | 4.119, 6.205 | FULL SPAN..... | 4.92, 6.194 |
| DATA ENTRY FIELD..... | 4.8 | GAP LENGTH..... | 4.191, 6.210 |
| DATA SET CLEAR..... | 4.72, 6.138 | GAP SWEEP ON/OFF..... | 4.189, 6.209 |
| DATA SET CLEAR ALL..... | 4.72, 6.138 | GAP SWEEP SETTINGS | 4.190 |
| DATA SET LIST..... | 4.71 | GATE ADJUST..... | 4.186 |
| DATAENTRY OPAQUE | 4.8 | GATE DELAY..... | 4.185, 6.209 |
| DATAENTRY X..... | 4.8 | GATE EXTERN..... | 4.185, 6.209 |
| DATAENTRY Y..... | 4.8 | GATE LENGTH..... | 4.185, 6.209 |
| DATE..... | 4.45, 6.229 | GATE LEVEL..... | 4.184, 6.208 |
| dB*/MHz..... | 4.97, 6.62 | GATE MODE LEVEL/EDGE | 4.184, 6.208 |
| dB μ A..... | 4.97, 6.62 | GATE ON / OFF..... | 4.183, 6.208 |
| dB μ V..... | 4.97, 6.62 | GATE POL..... | 4.184, 6.208 |
| dBm..... | 4.97, 6.62 | GATE RF POWER..... | 4.185, 6.209 |
| dBmV..... | 4.97, 6.62 | GATE SETTINGS..... | 4.184 |
| dBpW..... | 4.97, 6.62 | GENERAL SETUP..... | 4.34, 4.40 |
| DECIM SEP | 4.167, 6.118 | GPIO ADDRESS..... | 4.34, 4.40, 6.226 |
| DEFAULT COLORS..... | 4.7, 6.93 | GRID ABS/REL..... | 4.95, 4.99, 6.96 |
| DEFAULT CONFIG..... | 4.74, 6.142 | HARDCOPY DEVICE | 4.58, 4.60, 6.121 |
| DEFAULT POSITION..... | 4.8 | HARDWARE+OPTIONS..... | 4.14, 6.6 |
| DEFINE MACRO..... | 4.82 | HEADER ON/OFF..... | 4.167, 6.118 |
| DEFINE PAUSE..... | 4.83 | HOLD CONT ON/OFF | 4.160, 6.99 |
| DELETE..... | 4.69, 6.135, 6.137 | HORIZONTAL SCALING | 4.5, 6.131 |
| DELETE FACTOR/SET..... | 4.23, 6.175, 6.177 | INPUT CAL..... | 4.32, 6.89 |
| DELETE LIMIT LINE..... | 4.150, 6.28 | INPUT RF..... | 4.32, 6.89 |
| DELETE MACRO..... | 4.83 | INPUT SELECT | 4.101, 4.102 |
| DELETE VALUE (limit line)..... | 4.155 | INSERT VALUE (limit line)..... | 4.155 |
| DELTA 1 to 4..... | 4.128, 6.9, 6.10, 6.11 | KEY CLICK ON/OFF..... | 4.40 |
| DELTA 1/2..... | 6.9, 6.10, 6.11 | LAST SPAN..... | 4.92 |
| DELTA ABS REL..... | 4.129, 6.10 | LIMIT CHECK..... | 4.117, 6.33, 6.34, 6.35 |
| DELTA TO STEPSIZE | 4.127 | LINE (trigger)..... | 4.178, 6.235 |
| DETECTOR..... | 4.163 | LINEAR/%..... | 4.99, 6.98 |
| DETECTOR AUTOPEAK | 4.163, 6.181 | LINEAR/dB | 4.99, 6.98 |
| DETECTOR AVERAGE | 4.164, 6.181 | LOCK ALL..... | 3.19 |
| DETECTOR MAX PEAK..... | 4.163, 6.181 | LOCK DATA | 3.19 |
| DETECTOR MIN PEAK..... | 4.163, 6.181 | LOG 10dB/20dB/50dB/100dB/120dB..... | 4.98 |
| DETECTOR RMS..... | 4.164, 6.181 | LOG MANUAL | 4.99, 6.96, 6.98 |
| DETECTOR SAMPLE..... | 4.164, 6.181 | LOGO ON/OFF..... | 4.7, 6.92 |
| DISABLE ALL ITEMS..... | 4.74, 4.79, 6.142 | | |

| | | | |
|---|--------------------------|---|---------------------------------------|
| LOWER LEFT | 4.56, 6.124 | REF POINT LEVEL..... | 4.130, 6.13 |
| LOWER RIGHT | 4.56, 6.124 | REF POINT LVL OFFSET | 4.130, 6.13 |
| MACRO 1 to 7..... | 4.81 | REF POINT TIME | 4.130, 6.13 |
| MACRO TITLE..... | 4.83 | REF VALUE..... | 4.198, 6.97 |
| MAIN PLL BANDWIDTH | 4.175, 6.170 | REF VALUE POSITION..... | 4.197, 6.98 |
| MAKE DIRECTORY..... | 4.69, 6.136 | REFERENCE..... | 4.33, 6.206 |
| MARGIN..... | 6.61 | REFERENCE FIXED..... | 4.129, 6.13 |
| MARKER 1 to 4..... | 4.106, 6.39, 6.41 | REFERENCE INT/EXT..... | 4.31, 6.206 |
| MARKER 1/2..... | 6.39, 6.41 | REFERENCE LINE..... | 4.145, 6.17 |
| MARKER DEMOD..... | 4.109, 4.110 | REFERENCE POINT..... | 4.130, 6.13 |
| MARKER INFO 4.109, 6.14, 6.44, 6.51, 6.57, 6.58, 6.94 | | REFERENCE PROG | 4.33, 6.206 |
| MARKER ZOOM | 4.109, 6.45 | RENAME..... | 4.69, 6.136 |
| MAX HOLD | 4.159, 6.98, 6.166 | RES BW 3dB/6dB..... | 4.172, 6.168 |
| MAX LEVEL AUTO | 4.95, 6.97 | RES BW AUTO..... | 4.171, 6.168 |
| MAX LEVEL MANUAL..... | 4.95, 6.97 | RES BW MANUAL..... | 4.172, 6.167 |
| MEAN..... | 4.139, 6.58 | RESTORE | 4.47 |
| MIN | 4.134, 6.12, 6.42 | RF ATTEN MANUAL..... | 4.100, 6.127 |
| MIN HOLD..... | 4.160, 6.98, 6.166 | RF INPUT 50 OHM..... | 4.101, 4.102, 6.128 |
| MIXER LEVEL..... | 4.101, 6.129 | RF INPUT 75 OHM/RAM | 4.101, 4.102, 6.129 |
| MKR -> CENTER..... | 4.141, 6.59 | RF INPUT 75 OHM/RAZ..... | 4.101, 4.102, 6.129 |
| MKR -> CF STEPSIZE..... | 4.142, 6.59 | RF POWER (trigger)..... | 4.179, 6.235 |
| MKR -> REF LEVEL..... | 4.142, 6.60 | RMS..... | 4.139, 6.57 |
| MKR -> START..... | 4.142, 6.60 | SATURATION..... | 4.7, 6.93 |
| MKR -> STOP..... | 4.142, 6.60 | SAVE LIMIT LINE..... | 4.155 |
| MKR -> TRACE..... | 4.142, 6.10, 6.39 | SCR. SAVER ON/OFF..... | 4.7, 6.100 |
| MKR DEMOD ON/OFF..... | 4.109, 4.110, 6.46 | SCR. SAVER TIME..... | 4.7, 6.100 |
| MKR STOP TIME..... | 4.109, 4.110, 6.46 | SCREEN A BARGRAPH..... | 4.4 |
| MKR TO STEPSIZE..... | 4.127, 6.60 | SCREEN A SWEEP..... | 4.4 |
| MODE COUPLED | 4.5, 6.131 | SCREEN COUPLING | 4.5 |
| MODULATION | 4.203 | SCREENS UNCOUPLED | 4.5, 6.131 |
| MONITOR CONNECTED | 4.39 | SEARCH LIMIT ON/OFF..... | 4.137, 6.39 |
| MOUSE..... | 4.46 | SELECT ITEMS.. 4.74, 4.79, 6.138, 6.139, 6.140, 6.141 | |
| MOVE ZOOM START | 4.93, 6.95 | SELECT LIMIT LINE..... | 4.148, 6.21, 6.22, 6.28 |
| MOVE ZOOM STOP | 4.93, 6.95 | SELECT MACRO..... | 4.83 |
| MOVE ZOOM WINDOW | 4.93, 6.96 | SELECT MARKER..... | 4.134 |
| N dB DOWN..... | 4.137, 6.44 | SELECT OBJECT..... | 4.6 |
| NAME (limit line)..... | 4.153, 6.28 | SELECT QUADRANT..... | 4.56 |
| NEW FACT/SET..... | 4.24, 4.27, 6.173, 6.175 | SELFTEST..... | 4.15, 6.7 |
| NEW LIMIT LINE..... | 4.152 | SERVICE..... | 4.32, 6.89 |
| NEXT MIN..... | 4.135, 6.12, 6.42 | SET CP REFERENCE..... | 4.119, 6.205 |
| NEXT MIN LEFT | 4.135, 6.12, 6.42 | SET NO. OF ADJ CHAN'S..... | 4.114, 6.204 |
| NEXT MIN RIGHT..... | 4.135, 6.12, 6.42 | SETTINGS DEVICE 1/2..... | 4.58, 4.61 |
| NEXT PEAK..... | 4.134, 6.11, 6.41 | SGL SWEEP DISP OFF | 4.181, 6.126 |
| NEXT PEAK LEFT | 4.134, 6.12, 6.42 | SHAPE FACT 60/3dB..... | 4.138, 6.46 |
| NEXT PEAK RIGHT..... | 4.134, 6.11, 6.41 | SHAPE FACT 60/6dB..... | 4.138, 6.46 |
| NOISE..... | 4.112, 6.45 | SHIFT X LIMIT LINE..... | 4.155, 6.23 |
| NOISE SOURCE..... | 4.32, 6.89 | SHIFT Y LIMIT LINE..... | 4.155, 6.25, 6.26 |
| NORMALIZE | 4.196, 6.172 | SIGNAL COUNT..... | 4.111, 6.40 |
| OCCUPIED PWR BANDW..... | 4.124, 6.50, 6.51 | SIGNAL TRACK..... | 4.108, 6.47 |
| OPTIONS..... | 4.14, 4.31, 6.6 | SINGLE SWEEP..... | 4.180, 6.125 |
| PEAK..... | 4.134, 6.11, 6.41 | SLOPE POS/NEG..... | 4.179, 6.237 |
| PEAK EXCURSION | 4.135, 6.43 | SORT MODE..... | 4.69 |
| PEAK HOLD ON/OFF | 4.140, 6.59 | SOURCE CAL..... | 4.194 |
| PHASE NOISE..... | 4.131, 6.13 | SOURCE ON/OFF..... | 4.193, 6.143 |
| POWER MEAS SETTINGS..... | 4.114 | SOURCE POWER..... | 4.193, 6.213 |
| POWER OFFSET..... | 4.193, 6.213 | SPAN / RBW AUTO [50]..... | 4.177, 6.168 |
| PRE TRIGGER (gap sweep)..... | 4.190, 6.209 | SPAN / RBW MANUAL..... | 4.177, 6.168 |
| PREDEFINED COLORS | 4.7, 6.93 | SPAN FIXED | 4.84, 4.86, 4.88, 6.193, 6.195 |
| PRESEL PEAK | 4.11, 6.64 | SPAN MANUAL | 4.91, 6.194 |
| PROBE CODE ON/OFF..... | 4.98, 6.240 | SPLIT SCREEN..... | 4.4, 6.92 |
| RBW / VBW MANUAL..... | 4.177, 6.169 | START FIXED | 4.86, 4.88, 4.92, 6.193, 6.194, 6.195 |
| RBW / VBW NOISE..... | 4.177, 6.169 | START MANUAL | 4.84, 6.195 |
| RBW / VBW PULSE..... | 4.177, 6.169 | STATISTICS..... | 4.17, 6.90 |
| RBW / VBW SINE [1]..... | 4.176, 6.169 | STEPSIZE = CENTER..... | 4.90 |
| RBW <= NORM/FFT | 4.174, 6.168 | STEPSIZE AUTO..... | 4.127, 6.14, 6.43 |
| RBW 1kHz ANA/DIG | 4.173, 6.168 | STEPSIZE MANUAL..... | 4.90, 4.127, 6.14, 6.43, 6.193 |
| RBW UP/DOWN..... | 4.173 | STOP FIXED | 4.84, 4.88, 4.92, 6.193, 6.194, 6.195 |
| RECALL | 4.199, 6.172 | STOP MANUAL | 4.86, 6.195 |
| RECORD ON/OFF | 4.82 | SUM MKR..... | 4.138, 6.52 |
| REF LEVEL..... | 4.95, 6.96 | SUMMARY MARKER | 4.139 |
| REF LEVEL OFFSET..... | 4.95, 6.97 | SWEEP COUNT | 4.140, 4.159, 4.181, 6.208 |
| REF POINT FREQUENCY..... | 4.130, 6.13 | SWEEP TIME AUTO | 4.173, 6.207 |

- SWEEP TIME MANUAL 4.173, 6.207
 - SYSTEM MESSAGES 4.16, 6.230
 - T1-REF 4.165, 4.166, 6.61
 - T1-T2+REF 4.165, 4.166, 6.61
 - T1-T3+REF 4.165, 4.166, 6.61
 - THRESHOLD LINE 4.145, 6.16
 - TIME 4.39, 4.45, 6.231
 - TIME LINE 1/2 4.146, 6.17
 - TIME ON/OFF 4.7, 6.95
 - TINT 4.6, 6.93
 - TITLE 4.57, 6.123
 - TRACE MATH 4.165
 - TRACE MATH OFF 4.165, 4.166, 6.61
 - TRACKING GENERATOR 4.18, 4.193, 6.130, 6.143
 - TRANSD SET RANGES 4.29, 6.176
 - TRANSD SET UNIT 4.28, 6.176
 - TRANSDUCER FACTOR 4.22, 6.174
 - TRANSDUCER SET 4.22, 6.175, 6.177
 - TRC COLOR AUTO INC 4.55, 6.124
 - TRD FACTOR NAME 4.25, 6.173
 - TRD FACTOR UNIT 4.25, 6.173
 - TRD FACTOR VALUES 4.26, 6.174
 - TRD SET NAME 4.28, 6.175
 - TRG TO GAP TIME 4.191, 6.210
 - TRIGGER DELAY 4.179, 6.236
 - TRIGGER LEVEL (gap sweep) 4.190, 6.236
 - UNIT 4.96, 6.240
 - UNLOCK 3.19
 - UPDATE 4.47
 - UPDATE MESSAGES 4.16
 - UPPER LEFT 4.56, 6.124
 - UPPER RIGHT 4.56, 6.124
 - USER PORT A/B 4.35, 4.41, 6.128, 6.143
 - VALUES (limit line) 4.154, 6.25
 - VECTOR ANALYZER 4.19, 6.130
 - VERTICAL SCALING 4.5, 6.131
 - VIDEO (trigger) 4.178, 6.235, 6.236
 - VIDEO BW AUTO 4.172, 6.169
 - VIDEO BW MANUAL 4.172, 6.169
 - VIEW 4.157, 6.98
 - VOLT 4.98, 6.62
 - VOLUME 4.110, 6.231
 - WATT 4.98, 6.62
 - X OFFSET 4.150, 6.23
 - Y OFFSET 4.150, 6.24, 6.26
 - ZERO SPAN 4.91, 6.194
 - ZOOM 4.93, 6.95
 - ZOOM OFF 4.93, 6.95
 - Span 4.91
 - measurement window 4.84
 - Special characters 6.2
 - Split screen 3.9, 4.4
 - Split screen mode 4.4
 - SRE (service request enable register) 5.21
 - SRQ (service request) 5.21, 5.32
 - Start frequency
 - sweep 4.84
 - Start-Up 1.18, 1.56
 - Status byte (STB) 5.21
 - Status information 3.4
 - DIFOVL 3.4
 - ExtRef 3.4
 - IFOVLD 3.4
 - LO LvD 3.4
 - LO Lvl 3.4
 - LO unl 3.4
 - MAX / REF LVL 3.4
 - OCXO 3.4
 - OVLd 3.4
 - UNCAL 3.4
 - Status register
 - CONDition part 5.19
 - ENABLE part 5.19
 - ESE 5.22
 - ESR 5.22
 - EVENT part 5.19
 - NTRansition part 5.19
 - overview 5.20
 - PPE 5.22
 - PTRansition part 5.19
 - SRE 5.21
 - STATus OPERation 5.23
 - STATus QUEStionable 5.24
 - ACPLimit 5.25
 - FREQuency 5.26
 - LIMit 5.27
 - LMARgin 5.28
 - POWer 5.29
 - SYNC 5.30
 - TRANsducer 5.31
 - STB 5.21
 - structure 5.18
 - sum bit 5.19
 - Status reporting system 5.18
 - resetting values 5.18, 5.34, 6.214
 - STB (status byte) 5.21
 - Step size
 - center frequency 4.89
 - delta marker 4.132
 - marker 4.127
 - setting 3.20
 - Stop frequency
 - sweep 4.86
 - String 5.14
 - Suffix 5.11
 - Sum bit 5.19
 - Supply voltage, external noise source 4.32
 - Sweep
 - count 4.159, 4.181
 - coupling 4.170
 - gap 4.188
 - gap length 4.191
 - gated 4.182
 - mode 4.180
 - single 4.180
 - time 4.173
 - Switching on/off 1.20
 - Switching operations 4.17
 - Syntax elements
 - command 5.14
 - System messages 4.16
- ## T
- Table entry 3.18
 - TCP/IP operation 1.54, 1.85
 - Test functional 1.58
 - Text parameter 5.14
 - Thick Ethernet 1.45, 1.74
 - Thin Ethernet 1.44, 1.73
 - Time 4.39, 4.45
 - Trace 4.156
 - copy 4.160
 - detector 4.161
 - export 4.167
 - mathematics 4.165
 - Transducer 4.20
 - entry 4.23
 - set 4.27
 - switch on 4.21
 - Transmission parameters of RS-232-C 4.194, 8.7

| | |
|---------------------|-------|
| Trigger | |
| delay | 4.179 |
| external | 4.179 |
| free run..... | 4.178 |
| gap sweep..... | 4.190 |
| line | 4.178 |
| pre-trigger..... | 4.190 |
| RF power..... | 4.179 |
| slope | 4.179 |
| video | 4.178 |
| TV demodulator..... | 4.206 |
| TV-Trigger | 4.208 |

U

| | |
|------------------------|------------|
| UNCAL | 3.4 |
| Units | 4.96 |
| Universal command..... | 8.5 |
| UNLD..... | 3.4 |
| Upper case | 6.2 |
| User port | |
| configuration..... | 4.35, 4.41 |
| interface | 8.21 |

V

| | |
|---------------------------|--------------|
| Vector analyzer mode..... | 4.19 |
| Video bandwidth | 4.172 |
| View | 4.157 |
| Volume | 4.109, 4.110 |

W

| | |
|--------------------|------|
| White space..... | 5.14 |
| Windows NT | 1.23 |
| administrator..... | 1.23 |
| login | 1.23 |
| password..... | 1.23 |

Z

| | |
|-----------------|-------------|
| Zero span | 4.91 |
| Zoom | 4.93, 4.157 |
| amplitude..... | 4.157 |



ROHDE & SCHWARZ

Test and
Measurement Division

Operating Manual

SPECTRUM ANALYZER

FSEA20/30

1065.6000.20/.25/35

FSEB20/30

1066.3010.20/.25/35

FSEM20/30

1080.1505.20/.21/.25

1079.8500.30/.31/.35

FSEK20/30

1088.1491.20/.21/.25

1088.3494.30/.31/.35

Volume 2

Operating manual consists of 2 volumes

Printed in the Federal
Republic of Germany

Tabbed Divider Overview

Volume 1

Data Sheet

Safety Instructions

Certificate of quality

EC Certificate of Conformity

Support Center

List of R & S Representatives

Manuals for Signal Analyzer FSE

Tabbed Divider

| | | |
|----|------------|------------------------|
| 1 | Chapter 1: | Putting into Operation |
| 2 | Chapter 2: | Getting Started |
| 3 | Chapter 3: | Operation |
| 4 | Chapter 4: | Functional Description |
| 10 | | Index |

Volume 2

Safety Instructions

Manuals for Signal Analyzer FSE

Tabbed Divider

| | | |
|----|------------|-------------------------------------|
| 5 | Chapter 5: | Remote Control – Basics |
| 6 | Chapter 6: | Remote Control – Commands |
| 7 | Chapter 7: | Remote Control – Program Examples |
| 8 | Chapter 8: | Maintenance and Hardware Interfaces |
| 9 | Chapter 9: | Error Messages |
| 10 | | Index |



Before putting the product into operation for the first time, make sure to read the following



Safety Instructions

Rohde & Schwarz makes every effort to keep the safety standard of its products up to date and to offer its customers the highest possible degree of safety. Our products and the auxiliary equipment required for them are designed and tested in accordance with the relevant safety standards. Compliance with these standards is continuously monitored by our quality assurance system. This product has been designed and tested in accordance with the EC Certificate of Conformity and has left the manufacturer's plant in a condition fully complying with safety standards. To maintain this condition and to ensure safe operation, observe all instructions and warnings provided in this manual. If you have any questions regarding these safety instructions, Rohde & Schwarz will be happy to answer them.

Furthermore, it is your responsibility to use the product in an appropriate manner. This product is designed for use solely in industrial and laboratory environments or in the field and must not be used in any way that may cause personal injury or property damage. You are responsible if the product is used for an intention other than its designated purpose or in disregard of the manufacturer's instructions. The manufacturer shall assume no responsibility for such use of the product.

The product is used for its designated purpose if it is used in accordance with its operating manual and within its performance limits (see data sheet, documentation, the following safety instructions). Using the products requires technical skills and knowledge of English. It is therefore essential that the products be used exclusively by skilled and specialized staff or thoroughly trained personnel with the required skills. If personal safety gear is required for using Rohde & Schwarz products, this will be indicated at the appropriate place in the product documentation.

Symbols and safety labels

| | | | | | | | |
|--------------------------------|------------------------------------|--------------------------|----------------------|-------------|--------|-----------------|--|
| | | | | | | | |
| Observe operating instructions | Weight indication for units >18 kg | Danger of electric shock | Warning! Hot surface | PE terminal | Ground | Ground terminal | Attention! Electrostatic sensitive devices |

| | | | | | |
|-----------------------|--------------------|---------------------|--------------------------|------------------------------------|--|
| | | | | | |
| Supply voltage ON/OFF | Standby indication | Direct current (DC) | Alternating current (AC) | Direct/alternating current (DC/AC) | Device fully protected by double/reinforced insulation |

Safety Instructions

Observing the safety instructions will help prevent personal injury or damage of any kind caused by dangerous situations. Therefore, carefully read through and adhere to the following safety instructions before putting the product into operation. It is also absolutely essential to observe the additional safety instructions on personal safety that appear in other parts of the documentation. In these safety instructions, the word "product" refers to all merchandise sold and distributed by Rohde & Schwarz, including instruments, systems and all accessories.

Tags and their meaning

| | |
|-----------|--|
| DANGER | This tag indicates a safety hazard with a high potential of risk for the user that can result in death or serious injuries. |
| WARNING | This tag indicates a safety hazard with a medium potential of risk for the user that can result in death or serious injuries. |
| CAUTION | This tag indicates a safety hazard with a low potential of risk for the user that can result in slight or minor injuries. |
| ATTENTION | This tag indicates the possibility of incorrect use that can cause damage to the product. |
| NOTE | This tag indicates a situation where the user should pay special attention to operating the product but which does not lead to damage. |

These tags are in accordance with the standard definition for civil applications in the European Economic Area. Definitions that deviate from the standard definition may also exist. It is therefore essential to make sure that the tags described here are always used only in connection with the associated documentation and the associated product. The use of tags in connection with unassociated products or unassociated documentation can result in misinterpretations and thus contribute to personal injury or material damage.

Basic safety instructions

1. The product may be operated only under the operating conditions and in the positions specified by the manufacturer. Its ventilation must not be obstructed during operation. Unless otherwise specified, the following requirements apply to Rohde & Schwarz products:
prescribed operating position is always with the housing floor facing down, IP protection 2X, pollution severity 2, overvoltage category 2, use only in enclosed spaces, max. operation altitude max. 2000 m. Unless specified otherwise in the data sheet, a tolerance of $\pm 10\%$ shall apply to the nominal voltage and of $\pm 5\%$ to the nominal frequency.
2. Applicable local or national safety regulations and rules for the prevention of accidents must be observed in all work performed. The product may be opened only by authorized, specially trained personnel. Prior to performing any work on the product or opening the product, the product must be disconnected from the supply network. Any adjustments, replacements of parts, maintenance or repair must be carried out only by technical personnel authorized by Rohde & Schwarz. Only original parts may be used for replacing parts relevant to safety (e.g. power switches, power transformers, fuses). A safety test must always be performed after parts relevant to safety have been replaced (visual inspection, PE conductor test, insulation resistance measurement, leakage current measurement, functional test).
3. As with all industrially manufactured goods, the use of substances that induce an allergic reaction (allergens, e.g. nickel) such as aluminum cannot be generally excluded. If you develop an allergic reaction (such as a skin rash, frequent sneezing, red eyes or respiratory difficulties), consult a physician immediately to determine the cause.

Safety Instructions

4. If products/components are mechanically and/or thermally processed in a manner that goes beyond their intended use, hazardous substances (heavy-metal dust such as lead, beryllium, nickel) may be released. For this reason, the product may only be disassembled, e.g. for disposal purposes, by specially trained personnel. Improper disassembly may be hazardous to your health. National waste disposal regulations must be observed.
5. If handling the product yields hazardous substances or fuels that must be disposed of in a special way, e.g. coolants or engine oils that must be replenished regularly, the safety instructions of the manufacturer of the hazardous substances or fuels and the applicable regional waste disposal regulations must be observed. Also observe the relevant safety instructions in the product documentation.
6. Depending on the function, certain products such as RF radio equipment can produce an elevated level of electromagnetic radiation. Considering that unborn life requires increased protection, pregnant women should be protected by appropriate measures. Persons with pacemakers may also be endangered by electromagnetic radiation. The employer is required to assess workplaces where there is a special risk of exposure to radiation and, if necessary, take measures to avert the danger.
7. Operating the products requires special training and intense concentration. Make certain that persons who use the products are physically, mentally and emotionally fit enough to handle operating the products; otherwise injuries or material damage may occur. It is the responsibility of the employer to select suitable personnel for operating the products.
8. Prior to switching on the product, it must be ensured that the nominal voltage setting on the product matches the nominal voltage of the AC supply network. If a different voltage is to be set, the power fuse of the product may have to be changed accordingly.
9. In the case of products of safety class I with movable power cord and connector, operation is permitted only on sockets with earthing contact and protective earth connection.
10. Intentionally breaking the protective earth connection either in the feed line or in the product itself is not permitted. Doing so can result in the danger of an electric shock from the product. If extension cords or connector strips are implemented, they must be checked on a regular basis to ensure that they are safe to use.
11. If the product has no power switch for disconnection from the AC supply, the plug of the connecting cable is regarded as the disconnecting device. In such cases, it must be ensured that the power plug is easily reachable and accessible at all times (length of connecting cable approx. 2 m). Functional or electronic switches are not suitable for providing disconnection from the AC supply. If products without power switches are integrated in racks or systems, a disconnecting device must be provided at the system level.
12. Never use the product if the power cable is damaged. By taking appropriate safety measures and carefully laying the power cable, ensure that the cable cannot be damaged and that no one can be hurt by e.g. tripping over the cable or suffering an electric shock.
13. The product may be operated only from TN/TT supply networks fused with max. 16 A.
14. Do not insert the plug into sockets that are dusty or dirty. Insert the plug firmly and all the way into the socket. Otherwise this can result in sparks, fire and/or injuries.
15. Do not overload any sockets, extension cords or connector strips; doing so can cause fire or electric shocks.
16. For measurements in circuits with voltages $V_{rms} > 30 V$, suitable measures (e.g. appropriate measuring equipment, fusing, current limiting, electrical separation, insulation) should be taken to avoid any hazards.
17. Ensure that the connections with information technology equipment comply with IEC 950/EN 60950.
18. Never remove the cover or part of the housing while you are operating the product. This will expose circuits and components and can lead to injuries, fire or damage to the product.

Safety Instructions

19. If a product is to be permanently installed, the connection between the PE terminal on site and the product's PE conductor must be made first before any other connection is made. The product may be installed and connected only by a skilled electrician.
20. For permanently installed equipment without built-in fuses, circuit breakers or similar protective devices, the supply circuit must be fused in such a way that suitable protection is provided for users and products.
21. Do not insert any objects into the openings in the housing that are not designed for this purpose. Never pour any liquids onto or into the housing. This can cause short circuits inside the product and/or electric shocks, fire or injuries.
22. Use suitable overvoltage protection to ensure that no overvoltage (such as that caused by a thunderstorm) can reach the product. Otherwise the operating personnel will be endangered by electric shocks.
23. Rohde & Schwarz products are not protected against penetration of water, unless otherwise specified (see also safety instruction 1.). If this is not taken into account, there exists the danger of electric shock or damage to the product, which can also lead to personal injury.
24. Never use the product under conditions in which condensation has formed or can form in or on the product, e.g. if the product was moved from a cold to a warm environment.
25. Do not close any slots or openings on the product, since they are necessary for ventilation and prevent the product from overheating. Do not place the product on soft surfaces such as sofas or rugs or inside a closed housing, unless this is well ventilated.
26. Do not place the product on heat-generating devices such as radiators or fan heaters. The temperature of the environment must not exceed the maximum temperature specified in the data sheet.
27. Batteries and storage batteries must not be exposed to high temperatures or fire. Keep batteries and storage batteries away from children. If batteries or storage batteries are improperly replaced, this can cause an explosion (warning: lithium cells). Replace the battery or storage battery only with the matching Rohde & Schwarz type (see spare parts list). Batteries and storage batteries are hazardous waste. Dispose of them only in specially marked containers. Observe local regulations regarding waste disposal. Do not short-circuit batteries or storage batteries.
28. Please be aware that in the event of a fire, toxic substances (gases, liquids etc.) that may be hazardous to your health may escape from the product.
29. Please be aware of the weight of the product. Be careful when moving it; otherwise you may injure your back or other parts of your body.
30. Do not place the product on surfaces, vehicles, cabinets or tables that for reasons of weight or stability are unsuitable for this purpose. Always follow the manufacturer's installation instructions when installing the product and fastening it to objects or structures (e.g. walls and shelves).
31. Handles on the products are designed exclusively for personnel to hold or carry the product. It is therefore not permissible to use handles for fastening the product to or on means of transport such as cranes, fork lifts, wagons, etc. The user is responsible for securely fastening the products to or on the means of transport and for observing the safety regulations of the manufacturer of the means of transport. Noncompliance can result in personal injury or material damage.
32. If you use the product in a vehicle, it is the sole responsibility of the driver to drive the vehicle safely. Adequately secure the product in the vehicle to prevent injuries or other damage in the event of an accident. Never use the product in a moving vehicle if doing so could distract the driver of the vehicle. The driver is always responsible for the safety of the vehicle; the manufacturer assumes no responsibility for accidents or collisions.
33. If a laser product (e.g. a CD/DVD drive) is integrated in a Rohde & Schwarz product, do not use any other settings or functions than those described in the documentation. Otherwise this may be hazardous to your health, since the laser beam can cause irreversible damage to your eyes. Never try to take such products apart, and never look into the laser beam.



Por favor lea imprescindiblemente antes de la primera puesta en funcionamiento las siguientes informaciones de seguridad



Informaciones de seguridad

Es el principio de Rohde & Schwarz de tener a sus productos siempre al día con los estándares de seguridad y de ofrecer a sus clientes el máximo grado de seguridad. Nuestros productos y todos los equipos adicionales son siempre fabricados y examinados según las normas de seguridad vigentes. Nuestra sección de gestión de la seguridad de calidad controla constantemente que sean cumplidas estas normas. Este producto ha sido fabricado y examinado según el comprobante de conformidad adjunto según las normas de la CE y ha salido de nuestra planta en estado impecable según los estándares técnicos de seguridad. Para poder preservar este estado y garantizar un funcionamiento libre de peligros, deberá el usuario atenerse a todas las informaciones, informaciones de seguridad y notas de alerta. Rohde&Schwarz está siempre a su disposición en caso de que tengan preguntas referentes a estas informaciones de seguridad.

Además queda en la responsabilidad del usuario utilizar el producto en la forma debida. Este producto solamente fue elaborado para ser utilizado en la industria y el laboratorio o para fines de campo y de ninguna manera deberá ser utilizado de modo que alguna persona/cosa pueda ser dañada. El uso del producto fuera de sus fines definidos o despreciando las informaciones de seguridad del fabricante queda en la responsabilidad del usuario. El fabricante no se hace en ninguna forma responsable de consecuencias a causa del maluso del producto.

Se parte del uso correcto del producto para los fines definidos si el producto es utilizado dentro de las instrucciones del correspondiente manual del uso y dentro del margen de rendimiento definido (ver hoja de datos, documentación, informaciones de seguridad que siguen). El uso de los productos hace necesarios conocimientos profundos y el conocimiento del idioma inglés. Por eso se deberá tener en cuenta de exclusivamente autorizar para el uso de los productos a personas peritas o debidamente minuciosamente instruidas con los conocimientos citados. Si fuera necesaria indumentaria de seguridad para el uso de productos de R&S, encontrará la información debida en la documentación del producto en el capítulo correspondiente.

Símbolos y definiciones de seguridad

| | | | | | | | |
|-------------------------------------|---|-------------------------------|-----------------------------------|--------------------------------|-------------------|----------------------------|---|
| | | | | | | | |
| Ver manual de instrucciones del uso | Informaciones para maquinaria con un peso de > 18kg | Peligro de golpe de corriente | ¡Advertencia! Superficie caliente | Conexión a conductor protector | Conexión a tierra | Conexión a masa conductora | ¡Cuidado! Elementos de construcción con peligro de carga electrostática |

| | | | | | |
|---------------------------|---------------------|-----------------------|----------------------|----------------------------------|--|
| | | | | | |
| potencia EN MARCHA/PARADA | Indicación Stand-by | Corriente continua DC | Corriente alterna AC | Corriente continua/alterna DC/AC | El aparato está protegido en su totalidad por un aislamiento de doble refuerzo |

Informaciones de seguridad

Tener en cuenta las informaciones de seguridad sirve para tratar de evitar daños y peligros de toda clase. Es necesario de que se lean las siguientes informaciones de seguridad concienzudamente y se tengan en cuenta debidamente antes de la puesta en funcionamiento del producto. También deberán ser tenidas en cuenta las informaciones para la protección de personas que encontrarán en otro capítulo de esta documentación y que también son obligatorias de seguir. En las informaciones de seguridad actuales hemos juntado todos los objetos vendidos por Rohde&Schwarz bajo la denominación de „producto“, entre ellos también aparatos, instalaciones así como toda clase de accesorios.

Palabras de señal y su significado

| | |
|-------------|--|
| PELIGRO | Indica un punto de peligro con gran potencial de riesgo para el usuario. Punto de peligro que puede llevar hasta la muerte o graves heridas. |
| ADVERTENCIA | Indica un punto de peligro con un potencial de riesgo mediano para el usuario. Punto de peligro que puede llevar hasta la muerte o graves heridas . |
| ATENCIÓN | Indica un punto de peligro con un potencial de riesgo pequeño para el usuario. Punto de peligro que puede llevar hasta heridas leves o pequeñas |
| CUIDADO | Indica la posibilidad de utilizar mal el producto y a consecuencia dañarlo. |
| INFORMACIÓN | Indica una situación en la que deberían seguirse las instrucciones en el uso del producto, pero que no consecuentemente deben de llevar a un daño del mismo. |

Las palabras de señal corresponden a la definición habitual para aplicaciones civiles en el ámbito de la comunidad económica europea. Pueden existir definiciones diferentes a esta definición. Por eso se debiera tener en cuenta que las palabras de señal aquí descritas sean utilizadas siempre solamente en combinación con la correspondiente documentación y solamente en combinación con el producto correspondiente. La utilización de las palabras de señal en combinación con productos o documentaciones que no les correspondan puede llevar a malinterpretaciones y tener por consecuencia daños en personas u objetos.

Informaciones de seguridad elementales

1. El producto solamente debe ser utilizado según lo indicado por el fabricante referente a la situación y posición de funcionamiento sin que se obstruya la ventilación. Si no se convino de otra manera, es para los productos R&S válido lo que sigue: como posición de funcionamiento se define principalmente la posición con el suelo de la caja para abajo , modo de protección IP 2X, grado de suciedad 2, categoría de sobrecarga eléctrica 2, utilizar solamente en estancias interiores, utilización hasta 2000 m sobre el nivel del mar.
A menos que se especifique otra cosa en la hoja de datos, se aplicará una tolerancia de $\pm 10\%$ sobre el voltaje nominal y de $\pm 5\%$ sobre la frecuencia nominal.
2. En todos los trabajos deberán ser tenidas en cuenta las normas locales de seguridad de trabajo y de prevención de accidentes. El producto solamente debe de ser abierto por personal périto autorizado. Antes de efectuar trabajos en el producto o abrirlo deberá este ser desconectado de la corriente. El ajuste, el cambio de partes, la manutención y la reparación deberán ser solamente efectuadas por electricistas autorizados por R&S. Si se reponen partes con importancia para los aspectos de seguridad (por ejemplo el enchufe, los transformadores o los fusibles), solamente podrán ser sustituidos por partes originales. Despues de cada recambio de partes elementales para la seguridad deberá ser efectuado un control de

Informaciones de seguridad

- seguridad (control a primera vista, control de conductor protector, medición de resistencia de aislamiento, medición de medición de la corriente conductora, control de funcionamiento).
3. Como en todo producto de fabricación industrial no puede ser excluido en general de que se produzcan al usarlo elementos que puedan generar alergias, los llamados elementos alergénicos (por ejemplo el níquel). Si se produjeran en el trato con productos R&S reacciones alérgicas, como por ejemplo urticaria, estornudos frecuentes, irritación de la conjuntiva o dificultades al respirar, se deberá consultar inmediatamente a un médico para averiguar los motivos de estas reacciones.
 4. Si productos / elementos de construcción son tratados fuera del funcionamiento definido de forma mecánica o térmica, pueden generarse elementos peligrosos (polvos de sustancia de metales pesados como por ejemplo plomo, berilio, níquel). La partición elemental del producto, como por ejemplo sucede en el tratamiento de materias residuales, debe de ser efectuada solamente por personal especializado para estos tratamientos. La partición elemental efectuada inadecuadamente puede generar daños para la salud. Se deben tener en cuenta las directivas nacionales referentes al tratamiento de materias residuales.
 5. En el caso de que se produjeran agentes de peligro o combustibles en la aplicación del producto que debieran de ser transferidos a un tratamiento de materias residuales, como por ejemplo agentes refrigerantes que deben ser repuestos en periodos definidos, o aceites para motores, deberán ser tenidas en cuenta las prescripciones de seguridad del fabricante de estos agentes de peligro o combustibles y las regulaciones regionales para el tratamiento de materias residuales. Cuiden también de tener en cuenta en caso dado las prescripciones de seguridad especiales en la descripción del producto.
 6. Ciertos productos, como por ejemplo las instalaciones de radiación HF, pueden a causa de su función natural, emitir una radiación electromagnética aumentada. En vista a la protección de la vida en desarrollo deberían ser protegidas personas embarazadas debidamente. También las personas con un bypass pueden correr peligro a causa de la radiación electromagnética. El empresario está comprometido a valorar y señalar áreas de trabajo en las que se corra un riesgo de exposición a radiaciones aumentadas de riesgo aumentado para evitar riesgos.
 7. La utilización de los productos requiere instrucciones especiales y una alta concentración en el manejo. Debe de ponerse por seguro de que las personas que manejen los productos estén a la altura de los requerimientos necesarios referente a sus aptitudes físicas, psíquicas y emocionales, ya que de otra manera no se pueden excluir lesiones o daños de objetos. El empresario lleva la responsabilidad de seleccionar el personal usuario apto para el manejo de los productos.
 8. Antes de la puesta en marcha del producto se deberá tener por seguro de que la tensión preseleccionada en el producto equivalga a la del la red de distribución. Si es necesario cambiar la preselección de la tensión también se deberán en caso dabo cambiar los fusibles correspondientes del producto.
 9. Productos de la clase de seguridad I con alimentación móvil y enchufe individual de producto solamente deberán ser conectados para el funcionamiento a tomas de corriente de contacto de seguridad y con conductor protector conectado.
 10. Queda prohibida toda clase de interrupción intencionada del conductor protector, tanto en la toma de corriente como en el mismo producto ya que puede tener como consecuencia el peligro de golpe de corriente por el producto. Si se utilizaran cables o enchufes de extensión se deberá poner al seguro, que es controlado su estado técnico de seguridad.
 11. Si el producto no está equipado con un interruptor para desconectarlo de la red, se deberá considerar el enchufe del cable de distribución como interruptor. En estos casos deberá asegurar de que el enchufe sea de fácil acceso y nabejo (medida del cable de distribución aproximadamente 2 m). Los interruptores de función o electrónicos no son aptos para el corte de la red eléctrica. Si los productos sin interruptor están integrados en construcciones o instalaciones, se deberá instalar el interruptor al nivel de la instalación.

Informaciones de seguridad

12. No utilice nunca el producto si está dañado el cable eléctrico. Asegure a través de las medidas de protección y de instalación adecuadas de que el cable de eléctrico no pueda ser dañado o de que nadie pueda ser dañado por él, por ejemplo al tropezar o por un golpe de corriente.
13. Solamente está permitido el funcionamiento en redes de distribución TN/TT aseguradas con fusibles de como máximo 16 A.
14. Nunca conecte el enchufe en tomas de corriente sucias o llenas de polvo. Introduzca el enchufe por completo y fuertemente en la toma de corriente. Si no tiene en consideración estas indicaciones se arriesga a que se originen chispas, fuego y/o heridas.
15. No sobrecargue las tomas de corriente, los cables de extensión o los enchufes de extensión ya que esto pudiera causar fuego o golpes de corriente.
16. En las mediciones en circuitos de corriente con una tensión de entrada de $U_{eff} > 30 \text{ V}$ se deberá tomar las precauciones debidas para impedir cualquier peligro (por ejemplo medios de medición adecuados, seguros, limitación de tensión, corte protector, aislamiento etc.).
17. En caso de conexión con aparatos de la técnica informática se deberá tener en cuenta que estos cumplan los requisitos de la EC950/EN60950.
18. Nunca abra la tapa o parte de ella si el producto está en funcionamiento. Esto pone a descubierto los cables y componentes eléctricos y puede causar heridas, fuego o daños en el producto.
19. Si un producto es instalado fijamente en un lugar, se deberá primero conectar el conductor protector fijo con el conductor protector del aparato antes de hacer cualquier otra conexión. La instalación y la conexión deberán ser efectuadas por un electricista especializado.
20. En caso de que los productos que son instalados fijamente en un lugar sean sin protector implementado, autointerruptor o similares objetos de protección, deberá la toma de corriente estar protegida de manera que los productos o los usuarios estén suficientemente protegidos.
21. Por favor, no introduzca ningún objeto que no esté destinado a ello en los orificios de la caja del aparato. No vierta nunca ninguna clase de líquidos sobre o en la caja. Esto puede producir corto circuitos en el producto y/o puede causar golpes de corriente, fuego o heridas.
22. Asegúrese con la protección adecuada de que no pueda originarse en el producto una sobrecarga por ejemplo a causa de una tormenta. Si no se verá el personal que lo utilice expuesto al peligro de un golpe de corriente.
23. Los productos R&S no están protegidos contra el agua si no es que exista otra indicación, ver también punto 1. Si no se tiene en cuenta esto se arriesga el peligro de golpe de corriente o de daños en el producto lo cual también puede llevar al peligro de personas.
24. No utilice el producto bajo condiciones en las que pueda producirse y se hayan producido líquidos de condensación en o dentro del producto como por ejemplo cuando se desplaza el producto de un lugar frío a un lugar caliente.
25. Por favor no cierre ninguna ranura u orificio del producto, ya que estas son necesarias para la ventilación e impiden que el producto se caliente demasiado. No pongan el producto encima de materiales blandos como por ejemplo sofás o alfombras o dentro de una caja cerrada, si esta no está suficientemente ventilada.
26. No ponga el producto sobre aparatos que produzcan calor, como por ejemplo radiadores o calentadores. La temperatura ambiental no debe superar la temperatura máxima especificada en la hoja de datos.

Informaciones de seguridad

27. Baterías y acumuladores no deben de ser expuestos a temperaturas altas o al fuego. Guardar baterías y acumuladores fuera del alcance de los niños. Si las baterías o los acumuladores no son cambiados con la debida atención existirá peligro de explosión (atención celulas de Litio). Cambiar las baterías o los acumuladores solamente por los del tipo R&S correspondiente (ver lista de piezas de recambio). Baterías y acumuladores son deshechos problemáticos. Por favor tirenlos en los recipientes especiales para este fin. Por favor tengan en cuenta las prescripciones nacionales de cada país referente al tratamiento de deshechos. Nunca sometan las baterías o acumuladores a un corto circuito.
28. Tengan en consideración de que en caso de un incendio pueden escaparse gases tóxicos del producto, que pueden causar daños a la salud.
29. Por favor tengan en cuenta que en caso de un incendio pueden desprenderse del producto agentes venenosos (gases, líquidos etc.) que pueden generar daños a la salud.
30. No sitúe el producto encima de superficies, vehículos, estantes o mesas, que por sus características de peso o de estabilidad no sean aptas para él. Siga siempre las instrucciones de instalación del fabricante cuando instale y asegure el producto en objetos o estructuras (por ejemplo paredes y estantes).
31. Las asas instaladas en los productos sirven solamente de ayuda para el manejo que solamente está previsto para personas. Por eso no está permitido utilizar las asas para la sujecion en o sobre medios de transporte como por ejemplo grúas, carretillas elevadoras de horquilla, carros etc. El usuario es responsable de que los productos sean sujetados de forma segura a los medios de transporte y de que las prescripciones de seguridad del fabricante de los medios de transporte sean tenidas en cuenta. En caso de que no se tengan en cuenta pueden causarse daños en personas y objetos.
32. Si llega a utilizar el producto dentro de un vehículo, queda en la responsabilidad absoluta del conductor que conducir el vehículo de manera segura. Asegure el producto dentro del vehículo debidamente para evitar en caso de un accidente las lesiones u otra clase de daños. No utilice nunca el producto dentro de un vehículo en movimiento si esto pudiera distraer al conductor. Siempre queda en la responsabilidad absoluta del conductor la seguridad del vehículo y el fabricante no asumirá ninguna clase de responsabilidad por accidentes o colisiones.
33. Dado el caso de que esté integrado un producto de laser en un producto R&S (por ejemplo CD/DVD-ROM) no utilice otras instalaciones o funciones que las descritas en la documentación. De otra manera pondrá en peligro su salud, ya que el rayo laser puede dañar irreversiblemente sus ojos. Nunca trate de descomponer estos productos. Nunca mire dentro del rayo laser.

Contents of Manuals for Spectrum Analyzer FSE

Operating Manual FSE

The operating manual describes the following models and options:

- FSEA20/30 9kHz/20 Hz to 3,5 GHz
- FSEB20/30 9kHz/20 Hz to 7 GHz
- FSEM20/30 9kHz/20 Hz to 26,5 GHz
- FSEK20/30 9kHz/20 Hz to 40 GHz

- Option FSE-B3 TV Demodulator
- Option FSE-B5 FFT Filter
- Option FSE-B8/9/10/11 Tracking Generator
- Option FSE-B13 1 dB Attenuator
- Option FSE-B15 DOS Controller (Id.-Nr: 1073.5696.02/.03)
- Option FSE-B15 Windows NT Controller (Id.-Nr.: 1073.5696.06)
- Option FSE-B16 Ethernet Adapter
- Option FSE-B17 Second IEC/IEEE Bus Interface

Options FSE-B7, Vector Signal Analysis, and FSE-B21, External Mixer Output, are described in separate manuals.

The present operating manual contains comprehensive information about the technical data of the instrument, the setup and putting into operation of the instrument, the operating concept and controls as well as the operation of the FSE via the menus and via remote control. Typical measurement tasks for the FSE are explained using the functions offered by the menus and a selection of program examples.

In addition the operating manual gives information about maintenance of the instrument and about error detection listing the error messages which may be output by the instrument. It is subdivided into 2 volumes containing the data sheet plus 9 chapters:

Volume 1

- The data sheet** informs about guaranteed specifications and characteristics of the instrument.
- Chapter 1** describes the control elements and connectors on the front and rear panel as well as all procedures required for putting the FSE into operation and integration into a test system.
- Chapter 2** gives an introduction to typical measurement tasks of the FSE which are explained step by step.
- Chapter 3** describes the operating principles, the structure of the graphical interface and offers a menu overview.
- Chapter 4** forms a reference for manual control of the FSE and contains a detailed description of all instrument functions and their application.
- Chapter 10** contains an index for the operating manual.

Volume 2

- Chapter 5** describes the basics for programming the FSE, command processing and the status reporting system.
- Chapter 6** lists all the remote-control commands defined for the instrument. At the end of the chapter a alphabetical list of commands and a table of softkeys with command assignment is given.
- Chapter 7** contains program examples for a number of typical applications of the FSE.
- Chapter 8** describes preventive maintenance and the characteristics of the instrument's interfaces.
- Chapter 8** gives a list of error messages that the FSE may generate.
- Chapter 9** contains a list of error messages.
- Chapter 10** contains an index for the operating manual.

Service Manual - Instrument

The service manual - instrument informs on how to check compliance with rated specifications (performance test) and on the self tests.

Service Manual

The service manual is not delivered with the instrument but may be obtained from your R&S service department using the order number 1065.6016.94.

The service manual informs on instrument function, repair, troubleshooting and fault elimination. It contains all information required for the maintenance of FSE by exchanging modules. It contains information about the individual modules of FSE. This comprises the test and adjustment of the modules, fault detection within the modules and the interface description.

Contents - Chapter 5 "Remote Control - "Basics"

| | |
|---|-------------|
| 5 Remote Control - Basics | 5.1 |
| Introduction | 5.1 |
| Brief Instructions | 5.2 |
| Switchover to Remote Control | 5.2 |
| Indications during Remote Control..... | 5.2 |
| Remote Control via IEC Bus..... | 5.3 |
| Setting the Device Address..... | 5.3 |
| Return to Manual Operation..... | 5.3 |
| Remote Control via RS-232-Interface..... | 5.4 |
| Setting the Transmission Parameters..... | 5.4 |
| Return to Manual Operation..... | 5.4 |
| Limitations..... | 5.5 |
| Remote Control via RSIB Interface..... | 5.6 |
| Windows Environment..... | 5.6 |
| Unix Environment – with Windows NT Controller..... | 5.6 |
| Remote Control..... | 5.6 |
| Return to Manual Operation..... | 5.6 |
| Messages | 5.7 |
| IEE/IEEE-Bus Interface Messages..... | 5.7 |
| RSIB Interface Messages..... | 5.7 |
| Device Messages (Commands and Device Responses)..... | 5.8 |
| Structure and Syntax of the Device Messages | 5.9 |
| SCPI Introduction..... | 5.9 |
| Structure of a Command..... | 5.9 |
| Structure of a Command Line..... | 5.12 |
| Responses to Queries..... | 5.12 |
| Parameters..... | 5.13 |
| Overview of Syntax Elements..... | 5.14 |
| Instrument Model and Command Processing | 5.15 |
| Input Unit..... | 5.15 |
| Command Recognition..... | 5.16 |
| Data Set and Instrument Hardware..... | 5.16 |
| Status Reporting System..... | 5.16 |
| Output Unit..... | 5.17 |
| Command Sequence and Command Synchronization..... | 5.17 |
| Status Reporting System | 5.18 |
| Structure of an SCPI Status Register..... | 5.18 |
| Overview of the Status Registers..... | 5.20 |
| Description of the Status Registers..... | 5.21 |
| Status Byte (STB) and Service Request Enable Register (SRE)..... | 5.21 |
| IST Flag and Parallel Poll Enable Register (PPE)..... | 5.22 |
| Event-Status Register (ESR) and Event-Status-Enable Register (ESE)..... | 5.22 |
| STATUS:OPERation Register..... | 5.23 |
| STATUS:QUEStionable Register..... | 5.24 |
| STATUS QUEStionable:ACPLimit Register..... | 5.25 |

| | |
|--|------|
| STATus QUEStionable:FREQuency Register..... | 5.26 |
| STATus QUEStionable:LIMit Register | 5.27 |
| STATus QUEStionable:LMARgin Register | 5.28 |
| STATus QUEStionable:POWer Register | 5.29 |
| STATus QUEStionable:SYNC Register | 5.30 |
| STATus QUEStionable:TRANsducer Register | 5.31 |
| Application of the Status Reporting Systems..... | 5.32 |
| Service Request, Making Use of the Hierarchy Structure | 5.32 |
| Serial Poll | 5.32 |
| Parallel Poll..... | 5.33 |
| Query by Means of Commands..... | 5.33 |
| Error-Queue Query..... | 5.33 |
| Resetting Values of the Status Reporting System..... | 5.34 |

5 Remote Control - Basics

In this chapter you find:

- instructions how to put the FSE into operation via remote control,
- a general introduction to remote control of programmable instruments. This includes the description of the command structure and syntax according to the SCPI standard, the description of command execution and of the status registers,
- diagrams and tables describing the status registers used in the FSE.

In chapter 6, all remote control functions are described in detail. The subsystems are listed by alphabetical order according to SCPI. All commands and their parameters are listed by alphabetical order in the command list at the end of chapter 6.

Program examples for the FSE can be found in chapter 7.

The remote control interfaces and their interface functions are described in chapter 8.

Introduction

The instrument is equipped with an IEC-bus interface according to standard IEC 625.1/IEEE 488.2 and two RS-232 interfaces. The connector is located at the rear of the instrument and permits to connect a controller for remote control.

The option FSE-B15, (controller function) together with the option FSE B17 (2nd IEC-bus interface) may also be used as a controller (see chapter 1, section "Option FSE-B17 - Second IEC/IEEE Interface).

In addition, the instrument is equipped with an RSIB interface that allows instrument control by Visual C++ and Visual Basic programs

The instrument supports the SCPI version 1994.0 (Standard Commands for Programmable Instruments). The SCPI standard is based on standard IEEE 488.2 and aims at the standardization of device-specific commands, error handling and the status registers (see section "SCPI Introduction").

This section assumes basic knowledge of IEC-bus programming and operation of the controller. A description of the interface commands is to be obtained from the relevant manuals. The RSIB interface functions are matched to the function interface for IEC/IEEE-bus programming from National Instruments. The functions supported by the DLLs are listed in chapter 8.

The requirements of the SCPI standard placed on command syntax, error handling and configuration of the status registers are explained in detail in the respective sections. Tables provide a fast overview of the commands implemented in the instrument and the bit assignment in the status registers. The tables are supplemented by a comprehensive description of every command and the status registers. Detailed program examples of the main functions are to be found in chapter 7.

The program examples for IEC-bus programming are all written in Quick BASIC.

Brief Instructions

The short and simple operating sequence given below permits fast putting into operation of the instrument and setting of its basic functions. As a prerequisite, the IEC-bus address, which is factory-set to 20, must not have been changed.

1. Connect instrument and controller using IEC-bus cable.
2. Write and start the following program on the controller:

```
CALL IBFIND("DEV1", analyzer%)           'Open port to the instrument
CALL IBPAD(analyzer%, 20)                 'Inform controller about instrument address
CALL IBWRT(analyzer%, "*RST;*CLS")       'Reset instrument
CALL IBWRT(analyzer%, 'FREQ:CENT 100MHz') 'Set center frequency to 100 MHz
CALL IBWRT(analyzer%, 'FREQ:SPAN 10MHz')  'Set span to 10 MHz
CALL IBWRT(analyzer%, 'DISP:TRAC:Y:RLEV -10dBm') 'Set reference level to -10 dBm
```

The instrument now performs a sweep in the frequency range of 95 MHz to 105 MHz.

3. To return to manual control, press the *LOCAL* key at the front panel

Switchover to Remote Control

On power-on, the instrument is always in the manual operating state ("LOCAL" state) and can be operated via the front panel.

It is switched to remote control ("REMOTE" state)

| | |
|---------|--|
| IEC-bus | as soon as it receives an addressed command from a controller. |
| RS-232 | as soon as it receives the command '@REM' from a controller. |
| RSIB | as soon as it receives an addressed command from a controller. |

During remote control, operation via the front panel is disabled. The instrument remains in the remote state until it is reset to the manual state via the front panel or via remote control interfaces. Switching from manual operation to remote control and vice versa does not affect the remaining instrument settings.

Indications during Remote Control

Remote control mode is indicated by the LED "REMOTE" on the instrument's front panel. In this mode the softkeys, the function fields and the diagram labelling on the display are not shown.

Note: Command *SYSTEM:DISPlay:UPDate ON* activates all indications during remote control to check the instrument settings.

Remote Control via IEC Bus

Setting the Device Address

In order to operate the instrument via the IEC-bus, it must be addressed using the set IEC-bus address. The IEC-bus address of the instrument is factory-set to 20. It can be changed manually in the *SETUP - GENERAL SETUP* menu or via IEC bus. Addresses 0 to 31 are permissible.

- Manually:**
- Call *SETUP - GENERAL SETUP* menu
 - Enter desired address in table *GPIB ADDRESS*
 - Terminate input using one of the unit keys (=ENTER).

Via IEC bus:

| | |
|---|--------------------------------------|
| CALL IBFIND("DEV1", analyzer%) | 'Open port to the instrument |
| CALL IBPAD(analyzer%, 20) | 'Inform controller about old address |
| CALL IBWRT(analyzer%, "SYST:COMM:GPIB:ADDR 18") | 'Set instrument to new address |
| CALL IBPAD(analyzer%, 18) | 'Inform controller about new address |

Return to Manual Operation

Return to manual operation is possible via the front panel or the IEC bus.

- Manually:**
- Press the *LOCAL* key.

- Notes:**
- Before switchover, command processing must be completed as otherwise switchover to remote control is effected immediately.
 - The *LOCAL* key can be disabled by the universal command *LLO* (see chapter 8) in order to prevent unintentional switchover. In this case, switchover to manual mode is only possible via the IEC bus.
 - The *LOCAL* key can be enabled again by deactivating the *REN* line of the IEC bus (see chapter 8).

Via IEC bus:

| | |
|-----------------------|--------------------------------------|
| ... | |
| CALL IBLOC(analyzer%) | 'Set instrument to manual operation. |
| ... | |

Remote Control via RS-232-Interface

Setting the Transmission Parameters

To enable an error-free and correct data transmission, the parameters of the unit and the controller should have the same setting. Parameters can be manually changed in menu *SETUP-GENERAL SETUP* in table *COM PORT 1/2* or via remote control using the command `SYSTEM:COMMunicate:SERial1|2:....`.

The transmission parameters of the interfaces COM1 and COM2 are factory-set to the following values:

Instruments with Windows NT controller:

baudrate = 9600, data bits = 8, stop bits = 1, parity = NONE and owner = INSTRUMENT.

Manually:

Setting interface COM1|2

- Call *SETUP-GENERAL SETUP* menu
- Select desired baudrate, bits, stopbit, parity and protocoll in table *COM PORT 1/2*.
- Set owner to Instrument or INSTR and DOS in table *COM PORT1/2* (with option FSE-B15 only)
- Terminate input using one of the unit keys (=ENTER).

Instruments with MS DOS controller or without controller:

baudrate = 9600, data bits = 8, stop bits = 1, parity = NONE, protocoll = NONE and owner = INSTRUMENT.

Manually:

Setting interface COM1|2

- Call *SETUP-GENERAL SETUP* menu
- Select desired baudrate, bits, stopbit, parity and protocoll in table *COM PORT 1/2*.
- Set owner to Instrument or INSTR and DOS in table *COM PORT1/2* (with MS DOS option FSE-B15 only)
- Terminate input using one of the unit keys (=ENTER).

Return to Manual Operation

Return to manual operation is possible via the front panel or via RS-232 interface.

Manually:

- Press the *LOCAL* key.

Notes: *Before switchover, command processing must be completed as otherwise switchover to remote control is effected immediately.*

- *The LOCAL key can be disabled by the universal command LLO (see chapter 8) in order to prevent unintentional switchover. In this case, switchover to manual mode is only possible via remote control.*
- *The LOCAL key can be enabled again by sending the control codes "@LOC" via RS-232 (see chapter 8).*

Via RS-232:

```
...
V24puts(port, '@LOC');      Set instrument to manual operation.
...
```

Limitations

The following limitations apply if the unit is remote-controlled via the RS-232-C interface:

- No interface messages, some control codes are defined (see chapter 8).
- Only the Common Commands *OPC? can be used for command synchronization, *WAI and *OPC are not available.
- Block data cannot be transmitted.

When Windows NT is booted, data are output via the COM interface because of automatic external device recognition. Therefore, it is recommended to clear the input buffer of the controller before remote operation of the instrument via the COM interface.

Remote Control via RSIB Interface

Notes: The RSIB interface is only available for instruments equipped with controller option, FSE-B15.

Windows Environment

To access the measuring instruments via the RSIB interface the DLLs should be installed in the corresponding directories:

Instruments with Windows NT controller:

- RSIB.DLL in Windows NT `system` directory or control application directory.
- RSIB32.DLL in Windows NT `system32` directory or control application directory.

On the measuring instrument the DLL is already installed in the corresponding directory.

Instruments with MS DOS controller

- RSIB.DLL in Windows NT `system` directory or control application directory.

Unix Environment – with Windows NT Controller

In order to access the measuring equipment via the RSIB interface, copy the `librsib.so.X.Y` file to a directory for which the control application has read rights. `X.Y` in the file name indicates the version number of the library, for example `1.0` (for details see Chapter 8).

Remote Control

The control is performed with Visual C++ or Visual Basic programs. The local link to the internal controller is established with the name '@local'. If a remote controller is used, the instrument IP address is to be indicated here (only with Windows NT controller).

Via VisualBasic:

| | |
|----------------------|---|
| internal controller: | ud = RSDLLibfind ('@local', ibsta, iberr, ibcntl) |
| remote controller: | ud = RSDLLibfind ('82.1.1.200', ibsta, iberr, ibcntl) |

Return to Manual Operation

The return to manual operation can be performed via the front panel (*LOCAL* key) or the RSIB interface.

Manually: ➤ Press the *LOCAL* key.

Note: Before switchover, command processing must be completed as otherwise switchover to remote control is effected immediately.

Via RSIB:

```
...
ud = RSDLLibloc (ud, ibsta, iberr, ibcntl);
...
```

Messages

The messages transferred via the data lines of the IEC bus or the RSIB interface (see chapter 8) can be divided into two groups:

- **interface messages and**
- **device messages.**

Some control characters are defined for the control of the RS-232-interface (see chapter 8).

IEE/IEEE-Bus Interface Messages

Interface messages are transferred on the data lines of the IEC bus, the "ATN" control line being active. They are used for communication between controller and instrument and can only be sent by a controller which has the IEC-bus control. Interface commands can be subdivided into

- **universal commands and**
- **addressed commands.**

Universal commands act on all devices connected to the IEC bus without previous addressing, addressed commands only act on devices previously addressed as listeners. The interface messages relevant to the instrument are listed in chapter 8.

RSIB Interface Messages

The RSIB interface enables the instrument to be controlled by Visual C++ or Visual Basic programs. The interface functions are matched to the function interface for IEC/IEEE-bus programming from National Instruments.

The functions supported by interface are listed in chapter 8.

Device Messages (Commands and Device Responses)

Device messages are transferred on the data lines of the IEC bus, the "ATN" control line not being active. ASCII code is used. The device messages are more or less equal for the different interfaces. A distinction is made according to the direction in which they are sent on the IEC bus:

- **Commands** are messages the controller sends to the instrument. They operate the device functions and request informations.
The commands are subdivided according to two criteria:
 1. According to the effect they have on the instrument:
 - Setting commands** cause instrument settings such as reset of the instrument or setting the center frequency.
 - Queries** cause data to be provided for output on the IEC-bus, e.g. for identification of the device or polling the marker.
 2. According to their definition in standard IEEE 488.2:
 - Common Commands** are exactly defined as to their function and notation in standard IEEE 488.2. They refer to functions such as management of the standardized status registers, reset and selftest.
 - Device-specific commands** refer to functions depending on the features of the instrument such as frequency setting. A majority of these commands has also been standardized by the SCPI committee (cf. Section 3.5.1).
- **Device responses** are messages the instrument sends to the controller after a query. They can contain measurement results, instrument settings and information on the instrument status (cf. Section 3.5.4).

Structure and syntax of the device messages are described in the following section. The commands are listed and explained in detail in chapter 6.

Structure and Syntax of the Device Messages

SCPI Introduction

SCPI (Standard Commands for Programmable Instruments) describes a standard command set for programming instruments, irrespective of the type of instrument or manufacturer. The goal of the SCPI consortium is to standardize the device-specific commands to a large extent. For this purpose, a model was developed which defines the same functions inside a device or for different devices. Command systems were generated which are assigned to these functions. Thus it is possible to address the same functions with identical commands. The command systems are of a hierarchical structure.

Fig. 5-1 illustrates this tree structure using a section of command system SENSE, which controls the sensor functions of the devices.

SCPI is based on standard IEEE 488.2, i.e. it uses the same syntactic basic elements as well as the common commands defined in this standard. Part of the syntax of the device responses is defined with greater restrictions than in standard IEEE 488.2 (see Section "Responses to Queries").

Structure of a Command

The commands consist of a so-called header and, in most cases, one or more parameters. Header and parameter are separated by a "white space" (ASCII code 0 to 9, 11 to 32 decimal, e.g. blank). The headers may consist of several key words. Queries are formed by directly appending a question mark to the header.

Note: *The commands used in the following examples are not in every case implemented in the instrument.*

Common commands

Common commands consist of a header preceded by an asterisk "*" and one or several parameters, if any.

Examples: *RST RESET, resets the device
 *ESE 253 EVENT STATUS ENABLE, sets the bits of the
 event status enable register
 *ESR? EVENT STATUS QUERY, queries the
 contents of the event status register.

Device-specific commands

Hierarchy: Device-specific commands are of hierarchical structure (see Fig. 5-1). The different levels are represented by combined headers. Headers of the highest level (root level) have only one key word. This key word denotes a complete command system.

Example: `SENSe` This key word denotes the command system `SENSe`.

For commands of lower levels, the complete path has to be specified, starting on the left with the highest level, the individual key words being separated by a colon ":".

Example: `SENSe:FREQuency:SPAN:LINK START`

This command lies in the fourth level of the `SENSe` system. It determines which parameter remains unchanged when the span is changed. If `LINK` is set to `START`, the values of `CENTer` and `STOP` are adjusted when the span is changed.

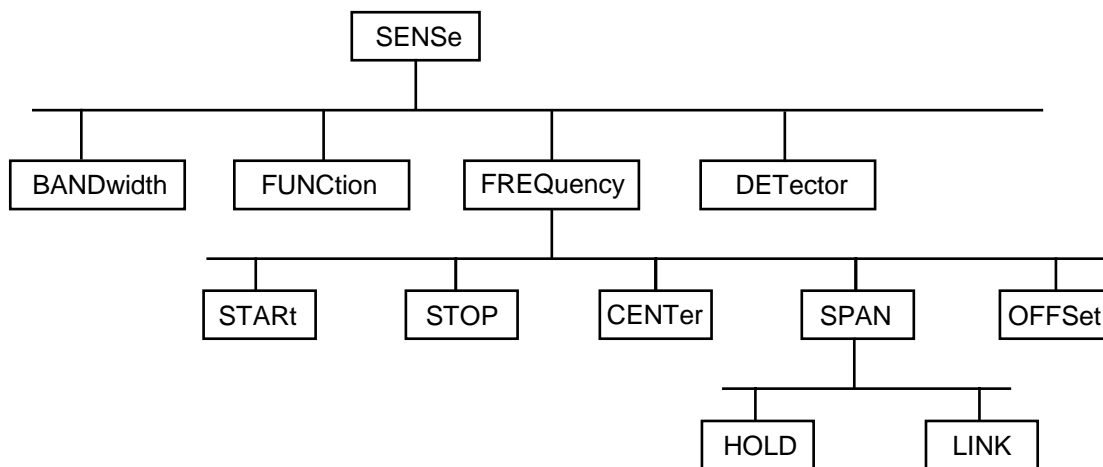

Fig. 5-1 Tree structure the SCPI command systems using the SENSE system by way of example

Some key words occur in several levels within one command system. Their effect depends on the structure of the command, that is to say, at which position in the header of a command they are inserted.

Example: `SOURce:FM:POLarity NORMal`

This command contains key word `POLarity` in the third command level. It defines the polarity between modulator and modulation signal.

`SOURce:FM:EXTernal:POLarity NORMal`

This command contains key word `POLarity` in the fourth command level. It defines the polarity between modulation voltage and the resulting direction of the modulation only for the external signal source indicated.

Optional key words: Some command systems permit certain key words to be optionally inserted into the header or omitted. These key words are marked by square brackets in the description. The full command length must be recognized by the instrument for reasons of compatibility with the SCPI standard. Some commands are considerably shortened by these optional key words.

Example: [SENSE]:BANDwidth[:RESolution]:AUTO

This command couples the resolution bandwidth of the instrument to other parameters. The following command has the same effect:

BANDwidth:AUTO

Note: *An optional key word must not be omitted if its effect is specified in detail by a numeric suffix.*

Long and short form: The key words feature a long form and a short form. Either the short form or the long form can be entered, other abbreviations are not permissible.

Beispiel: STATus:QUESTionable:ENABle 1= STAT:QUES:ENAB 1

Note: *The short form is marked by upper-case letters, the long form corresponds to the complete word. Upper-case and lower-case notation only serve the above purpose, the instrument itself does not make any difference between upper-case and lower-case letters.*

Parameter: The parameter must be separated from the header by a "white space". If several parameters are specified in a command, they are separated by a comma ",". A few queries permit the parameters MINimum, MAXimum and DEFault to be entered. For a description of the types of parameter, refer to Section 3.5.5.

Example: SENSE:FREQuency:STOP? MAXimum Response: 3.5E9
This query requests the maximal value for the stop frequency.

Numeric suffix: If a device features several functions or features of the same kind, e.g. inputs, the desired function can be selected by a suffix added to the command. Entries without suffix are interpreted like entries with the suffix 1.

Example: SYSTem:COMMunicate:SERial2:BAUD 9600

This command sets the baudrate of the second serial interface.

Parameters

Most commands require a parameter to be specified. The parameters must be separated from the header by a "white space". Permissible parameters are numerical values, Boolean parameters, text, character strings and block data. The type of parameter required for the respective command and the permissible range of values are specified in the command description (see Section 3.6).

Numerical values Numerical values can be entered in any form, i.e. with sign, decimal point and exponent. Values exceeding the resolution of the instrument are rounded up or down. The value range is $-9.9E37$ to $9.9E37$. The exponent is introduced by an "E" or "e". Entry of the exponent alone is not permissible. In the case of physical quantities, the unit can be entered. Permissible unit prefixes are G (giga), MA (mega), MOHM and MHZ are also permissible), K (kilo), M (milli), U (micro) and N (nano). If the unit is missing, the basic unit is used.

Example:

```
SENSe:FREQuency:STOP 1.5GHz = SENSe:FREQuency:STOP 1.5E9
```

Special numerical The texts MINimum, MAXimum, DEFault, UP and DOWN are interpreted as special numerical values.

In the case of a query, the numerical value is provided.

Example: Setting command: `SENSe:FREQuency:STOP MAXimum`

Query: `SENSe:FREQuency:STOP?` Response: `3.5E9`

MIN/MAX MINimum and MAXimum denote the minimum and maximum value.

DEF DEFault denotes a preset value which has been stored in the EPROM. This value conforms to the default setting, as it is called by the *RST command

UP/DOWN UP, DOWN increases or reduces the numerical value by one step. The step width can be specified via an allocated step command for each parameter which can be set via UP, DOWN.

INF/NINF INFINITY, Negative INFINITY (NINF) Negative INFINITY (NINF) represent the numerical values $-9.9E37$ or $9.9E37$, respectively. INF and NINF are only sent as device responses.

NAN Not A Number (NAN) represents the value $9.91E37$. NAN is only sent as device response. This value is not defined. Possible causes are the division by zero, the subtraction/addition of infinite and the representation of undefined values.

Boolean Parameters Boolean parameters represent two states. The ON state (logically true) is represented by ON or a numerical value unequal to 0. The OFF state (logically untrue) is represented by OFF or the numerical value 0. 0 or 1 is provided in a query.

Example: Setting command: `DISPlay:WINDow:STATE ON`

Query: `DISPlay:WINDow:STATE?` Response: `1`

Text Text parameters observe the syntactic rules for key words, i.e. they can be entered using a short or long form. Like any parameter, they have to be separated from the header by a white space. In the case of a query, the short form of the text is provided.

Example: Setting command: `INPut:COUPling GROund`
 Query: `INPut:COUPling?` Response `GRO`

Strings Strings must always be entered in quotation marks (' or ").

Example: `SYSTem:LANGUage "SCPI"` or
`SYSTem:LANGUage 'SCPI'`

Block data Block data are a transmission format which is suitable for the transmission of large amounts of data. A command using a block data parameter has the following structure:

Example: `HEADer:HEADer #45168xxxxxxxx`

ASCII character # introduces the data block. The next number indicates how many of the following digits describe the length of the data block. In the example the 4 following digits indicate the length to be 5168 bytes. The data bytes follow. During the transmission of these data bytes all End or other control signs are ignored until all bytes are transmitted..

Overview of Syntax Elements

The following survey offers an overview of the syntax elements.

- `:` The colon separates the key words of a command.
In a command line the separating semicolon marks the uppermost command level.
- `;` The semicolon separates two commands of a command line.
It does not alter the path.
- `,` The comma separates several parameters of a command.
- `?` The question mark forms a query.
- `*` The asterisk marks a common command.
- `"`
`'` Double or single quotation marks introduce a string and terminate it.
- `#` The double dagger # introduces block data.
- A "white space" (ASCII-Code 0 to 9, 11 to 32 decimal, e.g. blank) separates header and parameter.

Instrument Model and Command Processing

The instrument model shown in Fig. 5-2 has been made viewed from the standpoint of the servicing of IEC-bus commands. The individual components work independently of each other and simultaneously. They communicate by means of so-called "messages".

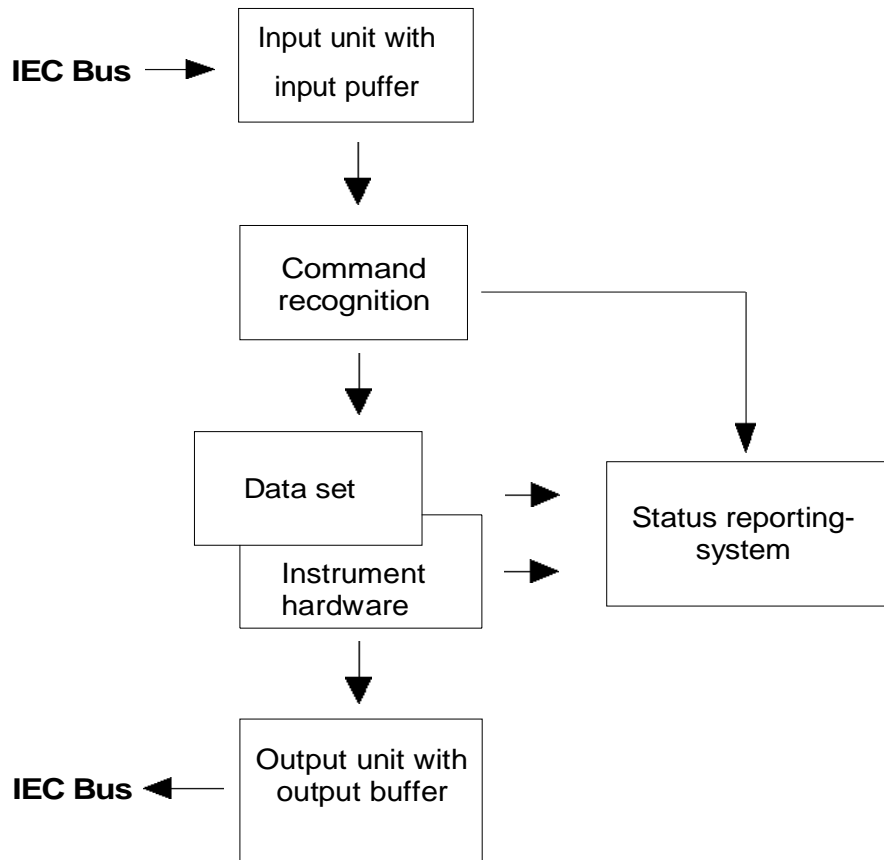

Fig. 5-2 Instrument model in the case of remote control by means of the IEC bus

Input Unit

The input unit receives commands character by character from the IEC bus and collects them in the input buffer. The input buffer has a size of 256 characters. The input unit sends a message to the command recognition as soon as the input buffer is full or as soon as it receives a delimiter, <PROGRAM MESSAGE TERMINATOR>, as defined in IEEE 488.2, or the interface message DCL.

If the input buffer is full, the IEC-bus traffic is stopped and the data received up to then are processed. Subsequently the IEC-bus traffic is continued. If, however, the buffer is not yet full when receiving the delimiter, the input unit can already receive the next command during command recognition and execution. The receipt of a DCL clears the input buffer and immediately initiates a message to the command recognition.

Command Recognition

The command recognition analyses the data received from the input unit. It proceeds in the order in which it receives the data. Only a DCL is serviced with priority, a GET (Group Execute Trigger), e.g., is only executed after the commands received before as well. Each recognized command is immediately transferred to the data set but without being executed there at once.

Syntactical errors in the command are recognized here and supplied to the status reporting system. The rest of a command line after a syntax error is analysed further if possible and serviced.

If the command recognition recognizes a delimiter or a DCL, it requests the data set to set the commands in the instrument hardware as well now. Subsequently it is immediately prepared to process commands again. This means for the command servicing that further commands can already be serviced while the hardware is still being set ("overlapping execution").

Data Set and Instrument Hardware

Here the expression "instrument hardware" denotes the part of the instrument fulfilling the actual instrument function - signal generation, measurement etc. The controller is not included.

The instrument data base is a detailed reproduction of the instrument hardware in the software.

IEC-bus setting commands lead to an alteration in the data set. The data base management enters the new values (e.g. frequency) into the data base, however, only passes them on to the hardware when requested by the command recognition.

The data are only checked for their compatibility among each other and with the instrument hardware immediately before they are transmitted to the instrument hardware. If the detection is made that an execution is not possible, an "execution error" is signalled to the status reporting system. The alteration of the data base are cancelled, the instrument hardware is not reset.

IEC-bus queries induce the data set management to send the desired data to the output unit.

Status Reporting System

The status reporting system collects information on the instrument state and makes it available to the output unit on request. The exact structure and function are described in the following section.

Output Unit

The output unit collects the information requested by the controller, which it receives from the data set management. It processes it according to the SCPI rules and makes it available in the output buffer. The output buffer has a size of 4096 characters. If the information requested is longer, it is made available "in portions" without this being recognized by the controller.

If the instrument is addressed as a talker without the output buffer containing data or awaiting data from the data set management, the output unit sends error message "Query UNTERMINATED" to the status reporting system. No data are sent on the IEC bus, the controller waits until it has reached its time limit. This behaviour is specified by SCPI.

Command Sequence and Command Synchronization

What has been said above makes clear that all commands can potentially be carried out overlapping. Equally, setting commands within one command line are not absolutely serviced in the order in which they have been received.

In order to make sure that commands are actually carried out in a certain order, each command must be sent in a separate command line, that is to say, with a separate IBWRT()-call.

In order to prevent an overlapping execution of commands, one of commands *OPC, *OPC? or *WAI must be used. All three commands cause a certain action only to be carried out after the hardware has been set and has settled. By a suitable programming, the controller can be forced to wait for the respective action to occur (cf. Table 5-1).

Table 5-1 Synchronisation using *OPC, *OPC? and *WAI

| Commnd | Action after the hardware has settled | Programming the controller |
|--------|---|---|
| *OPC | Setting the operation-complete bit in the ESR | - Setting bit 0 in the ESE - Setting bit 5 in the SRE - Waiting for service request (SRQ) |
| *OPC? | Writing a "1" into the output buffer | Addressing the instrument as a talker |
| *WAI | Continuing the IEC-bus handshake | Sending the next command |

An example as to command synchronization can be found in chapter 7 "Program Examples".

Status Reporting System

The status reporting system (cf. Fig. 5-3) stores all information on the present operating state of the instrument, e.g. that the instrument presently carries out an AUTORANGE and on errors which have occurred. This information is stored in the status registers and in the error queue. The status registers and the error queue can be queried via IEC bus.

The information is of a hierarchical structure. The register status byte (STB) defined in IEEE 488.2 and its associated mask register service request enable (SRE) form the uppermost level. The STB receives its information from the standard event status register (ESR) which is also defined in IEEE 488.2 with the associated mask register standard event status enable (ESE) and registers STATus:OPERation and STATus:QUESTionable which are defined by SCPI and contain detailed information on the instrument.

The IST flag ("Individual STatus") and the parallel poll enable register (PPE) allocated to it are also part of the status reporting system. The IST flag, like the SRQ, combines the entire instrument status in a single bit. The PPE fulfills an analog function for the IST flag as the SRE for the service request.

The output buffer contains the messages the instrument returns to the controller. It is not part of the status reporting system but determines the value of the MAV bit in the STB and thus is represented in Fig. 5-3.

Table 5-12 at the end of this chapter comprises the different commands and events causing the status reporting system to be reset.

Structure of an SCPI Status Register

Each SCPI register consists of 5 parts which each have a width of 16 bits and have different functions (cf. Fig. 5-2). The individual bits are independent of each other, i.e. each hardware status is assigned a bit number which is valid for all five parts. For example, bit 3 of the STATus:OPERation register is assigned to the hardware status "wait for trigger" in all five parts. Bit 15 (the most significant bit) is set to zero for all parts. Thus the contents of the register parts can be processed by the controller as positive integer.

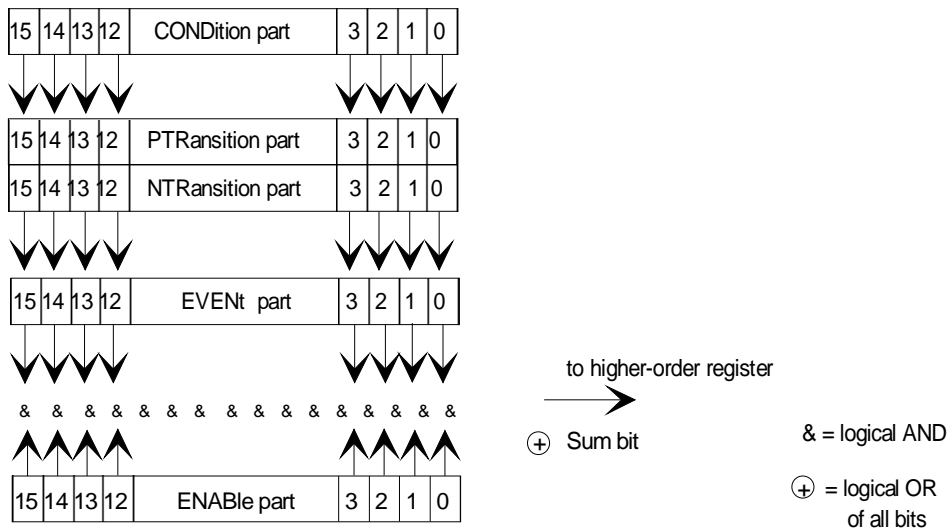

Fig. 5-2 The status-register model

| | |
|-------------------------|--|
| CONDition part | The CONDition part is directly written into by the hardware or the sum bit of the next lower register. Its contents reflects the current instrument status. This register part can only be read, but not written into or cleared. Its contents is not affected by reading. |
| PTRansition part | The Positive-TRansition part acts as an edge detector. When a bit of the CONDition part is changed from 0 to 1, the associated PTR bit decides whether the EVENT bit is set to 1. PTR bit =1: the EVENT bit is set. PTR bit =0: the EVENT bit is not set. This part can be written into and read at will. Its contents is not affected by reading. |
| NTRansition part | The Negative-TRansition part also acts as an edge detector. When a bit of the CONDition part is changed from 1 to 0, the associated NTR bit decides whether the EVENT bit is set to 1. NTR-Bit = 1: the EVENT bit is set. NTR-Bit = 0: the EVENT bit is not set. This part can be written into and read at will. Its contents is not affected by reading. With these two edge register parts the user can define which state transition of the condition part (none, 0 to 1, 1 to 0 or both) is stored in the EVENT part. |
| EVENT part | The EVENT part indicates whether an event has occurred since the last reading, it is the "memory" of the condition part. It only indicates events passed on by the edge filters. It is permanently updated by the instrument. This part can only be read by the user. During reading, its contents is set to zero. In linguistic usage this part is often equated with the entire register. |
| ENABLE part | The ENABLE part determines whether the associated EVENT bit contributes to the sum bit (cf. below). Each bit of the EVENT part is ANDed with the associated ENABLE bit (symbol '&'). The results of all logical operations of this part are passed on to the sum bit via an OR function (symbol '+'). ENABLE-Bit = 0: the associated EVENT bit does not contribute to the sum bit ENABLE-Bit = 1: if the associated EVENT bit is "1", the sum bit is set to "1" as well. This part can be written into and read by the user at will. Its contents is not affected by reading. |
| Sum bit | As indicated above, the sum bit is obtained from the EVENT and ENABLE part for each register. The result is then entered into a bit of the CONDition part of the higher-order register. The instrument automatically generates the sum bit for each register. Thus an event, e.g. a PLL that has not locked, can lead to a service request throughout all levels of the hierarchy. |
| Note: | <i>The service request enable register SRE defined in IEEE 488.2 can be taken as ENABLE part of the STB if the STB is structured according to SCPI. By analogy, the ESE can be taken as the ENABLE part of the ESR.</i> |

Overview of the Status Registers

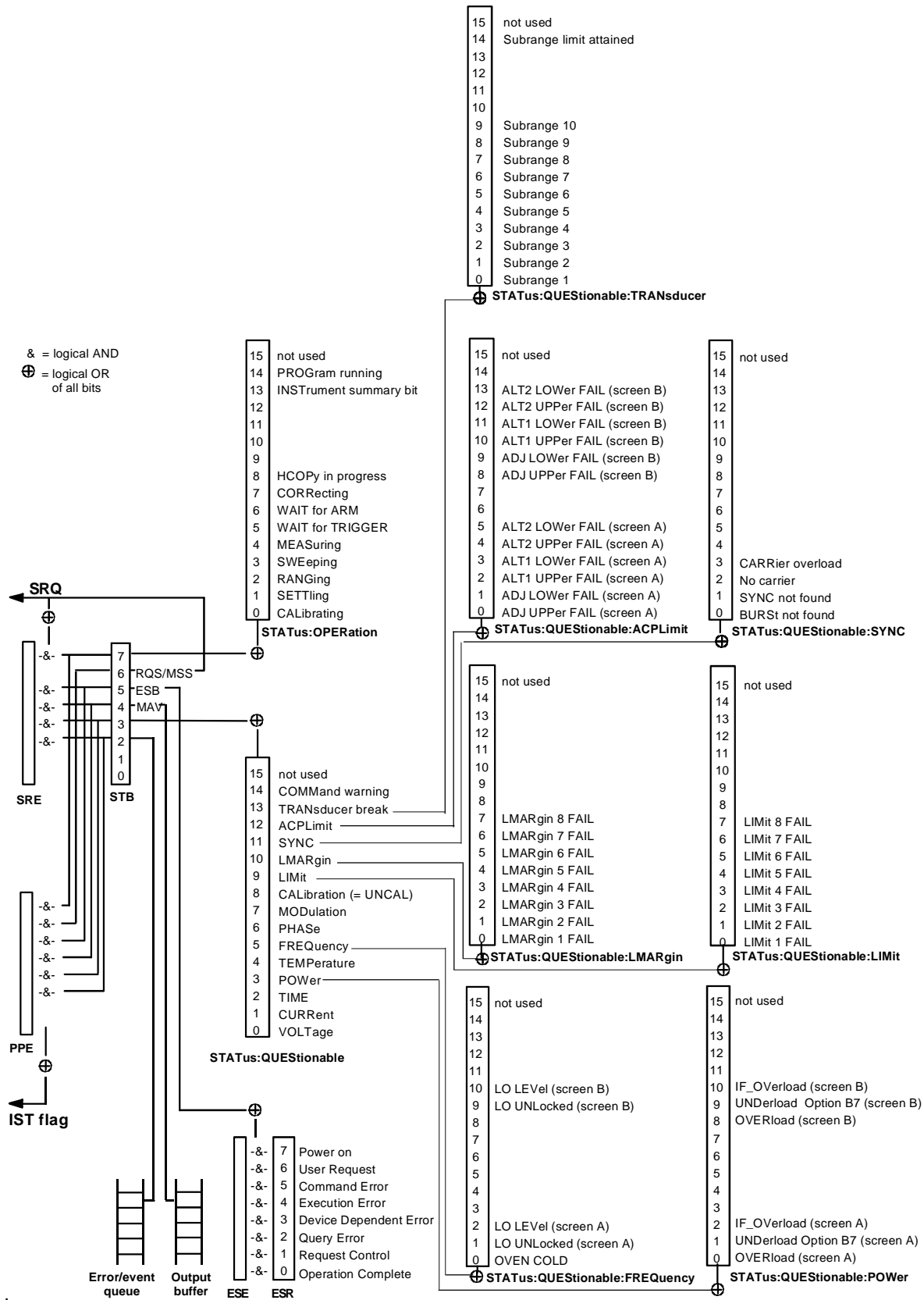

Fig. 5-3 Overview of the status registers

Description of the Status Registers

Status Byte (STB) and Service Request Enable Register (SRE)

The STB is already defined in IEEE 488.2. It provides a rough overview of the instrument status by collecting the pieces of information of the lower registers. It can thus be compared with the CONDition part of an SCPI register and assumes the highest level within the SCPI hierarchy. A special feature is that bit 6 acts as the sum bit of the remaining bits of the status byte.

The STATUS BYTE is read out using the command "*STB?" or a serial poll.

The STB implies the SRE. It corresponds to the ENABLE part of the SCPI registers as to its function. Each bit of the STB is assigned a bit in the SRE. Bit 6 of the SRE is ignored. If a bit is set in the SRE and the associated bit in the STB changes from 0 to 1, a Service Request (SRQ) is generated on the IEC bus, which triggers an interrupt in the controller if this is appropriately configured and can be further processed there.

The SRE can be set using command "*SRE" and read using "*SRE?".

Table 5-2 Meaning of the bits in the status byte

| Bit No. | Meaning |
|---------|---|
| 2 | <p>Error Queue not empty</p> <p>The bit is set when an entry is made in the error queue. If this bit is enabled by the SRE, each entry of the error queue generates a Service Request. Thus an error can be recognized and specified in greater detail by polling the error queue. The poll provides an informative error message. This procedure is to be recommended since it considerably reduces the problems involved with IEC-bus control.</p> |
| 3 | <p>QUESTIONable status sum bit</p> <p>The bit is set if an EVENT bit is set in the QUESTIONable-Status register and the associated ENABLE bit is set to 1. A set bit indicates a questionable instrument status, which can be specified in greater detail by polling the QUESTIONable-Status register.</p> |
| 4 | <p>MAV bit (message available)</p> <p>The bit is set if a message is available in the output buffer which can be read. This bit can be used to enable data to be automatically read from the instrument to the controller (cf. chapter 7, program examples).</p> |
| 5 | <p>ESB bit</p> <p>Sum bit of the event status register. It is set if one of the bits in the event status register is set and enabled in the event status enable register. Setting of this bit implies an error or an event which can be specified in greater detail by polling the event status register.</p> |
| 6 | <p>MSS bit (master status summary bit)</p> <p>The bit is set if the instrument triggers a service request. This is the case if one of the other bits of this registers is set together with its mask bit in the service request enable register SRE.</p> |
| 7 | <p>OPERation status register sum bit</p> <p>The bit is set if an EVENT bit is set in the OPERation-Status register and the associated ENABLE bit is set to 1. A set bit indicates that the instrument is just performing an action. The type of action can be determined by polling the OPERation-status register.</p> |

IST Flag and Parallel Poll Enable Register (PPE)

By analogy with the SRQ, the IST flag combines the entire status information in a single bit. It can be queried by means of a parallel poll or using command "*IST?".

The parallel poll enable register (PPE) determines which bits of the STB contribute to the IST flag. The bits of the STB are ANDed with the corresponding bits of the PPE, with bit 6 being used as well in contrast to the SRE. The Ist flag results from the ORing of all results. The PPE can be set using commands "*PRE" and read using command "*PRE?".

Event-Status Register (ESR) and Event-Status-Enable Register (ESE)

The ESR is already defined in IEEE 488.2. It can be compared with the EVENT part of an SCPI register. The event status register can be read out using command "*ESR?".

The ESE is the associated ENABLE part. It can be set using command "*ESE" and read using command "*ESE?".

Table 5-3 Meaning of the bits in the event status register

| Bit No. | Meaning |
|---------|---|
| 0 | Operation Complete This bit is set on receipt of the command *OPC exactly when all previous commands have been executed. |
| 1 | Request Control This bit is set if the instrument requests the controller function. This is the case when hardcopy is outputted to a printer or a plotter via the IEC-bus. |
| 2 | Query Error This bit is set if either the controller wants to read data from the instrument without having send a query, or if it does not fetch requested data and sends new instructions to the instrument instead. The cause is often a query which is faulty and hence cannot be executed. |
| 3 | Device-dependent Error This bit is set if a device-dependent error occurs. An error message with a number between -300 and -399 or a positive error number, which denotes the error in greater detail, is entered into the error queue (cf. chapter 9, Error Messages). |
| 4 | Execution Error This bit is set if a received command is syntactically correct, however, cannot be performed for other reasons. An error message with a number between -200 and -300, which denotes the error in greater detail, is entered into the error queue (cf. chapter 9, Error Messages). |
| 5 | Command Error This bit is set if a command which is undefined or syntactically incorrect is received. An error message with a number between -100 and -200, which denotes the error in greater detail, is entered into the rror queue (cf. chapter 9, -Error Messages). |
| 6 | User Request This bit is set on pressing the LOCAL key. |
| 7 | Power On (supply voltage on) This bit is set on switching on the instrument. |

STATus:OPERation Register

In the CONDition part, this register contains information on which actions the instrument is being executing or, in the EVENt part, information on which actions the instrument has executed since the last reading. It can be read using commands "STATus:OPERation:CONDition?" or "STATus:OPERation[:EVENT]?".

Table 5-4 Meaning of the bits in the STATus.OPERation register

| Bit No. | Meaning |
|---------|---|
| 0 | CALibrating This bit is set as long as the instrument is performing a calibration. |
| 1 | SETTling This bit is set as long as the new status is settling after a setting command. It is only set if the settling time is longer than the command processing time. |
| 2 | RANGing This bit is set as long as the instrument is changing a range (e.g. Autorange). |
| 3 | SWEeping This bit is set while the instrument is performing a sweep. |
| 4 | MEASuring This bit is set while the instrument is performing a measurement. |
| 5 | WAIT for TRIGGER This bit is set as long as the instrument is waiting for a trigger event. |
| 6 | WAIT for ARM This bit is set as long as the instrument is waiting for an arming event. |
| 7 | CORRecting This bit is set while the instrument is performing a correction. |
| 8 | HardCOPy in progress This bit is set while the instrument is printing a hardcopy. |
| 9-12 | Device dependent |
| 13 | INSTrument Summary Bit This bit is set when one or more logical instruments is reporting a status message. |
| 14 | PROGram running This bit is set while the instrument is performing a program. |
| 15 | This bit is always 0 |

The FSE supports bits 0 and 8.

STATus:QUEStionable Register

This register comprises information about indefinite states which may occur if the unit is operated without meeting the specifications. It can be queried by commands `STATus:QUEStionable:CONDition?` and `STATus:QUEStionable[:EVENT]?`.

Table 5-5 Meaning of bits in STATus:QUEStionable register

| Bit No. | Meaning |
|---------|---|
| 0 | VOLTage This bit is set if a questionable voltage occurs. |
| 1 | CURRent This bit is set if a questionable current occurs. |
| 2 | TIME This bit is set if a questionable time occurs. |
| 3 | POWER This bit is set if a questionable power occurs (cf. also section "STATus:QUEStionable:POWERRegister") |
| 4 | TEMPerature This bit is set if a questionable temperature occurs. |
| 5 | FREQuency The bit is set if a frequency is questionable (cf. section "STATus:QUEStionable:FREQuency Register") |
| 6 | PHASe The bit is set if a phase value is questionable. |
| 7 | MODulation The bit is set if a modulation is performed questionably. |
| 8 | CALibration The bit is set if a measurement is performed uncalibrated ($\hat{=}$ label "UNCAL") |
| 9 | LIMit (unit-dependent) This bit is set if a limit value is violated (see also section STATus:QUEStionable:LIMit Register) |
| 10 | LMARgin (unit-dependent) This bit is set if a margin is violated (see also section STATus:QUEStionable:LMARgin Register) |
| 11 | SYNC (unit-dependent) This bit is set if, during measurements with Option B7 (Signal Vector Analysis), the synchronization with midamble or a successful search for bursts cannot be performed (see also STATus:QUEStionable:SYNC Register) |
| 12 | ACPLimit (unit-dependent) This bit is set if a limit for the adjacent channel power measurement is violated (see also section STATus:QUEStionable:ACPLimit Register) |
| 13 | TRANsducer break This bit is set when the limit of the transducer set subrange is attained. |
| 14 | COMMand Warning This bit is set if the instrument ignores parameters when executing a command. |
| 15 | This bit is always 0. |

The FSE supports bits 3, 5, 7, 8, 9, 10, 11, 12 and 13, bits 7 (MODulation) and 11 (SYNC) only with option FSE-B7, Vector Signal Analysis'.

STATus QUESTIONable:ACPLimit Register

This register comprises information about the observance of limits during adjacent power measurements. It can be queried with commands 'STATus:QUESTIONable:ACPLimit:CONDition?' and 'STATus:QUESTIONable:ACPLimit[:EVENT]?'

Table 5- Meaning of bits in STATus:QUESTIONable:ACPLimit register

| Bit No. | Meaning |
|---------|---|
| 0 | ADJ UPPER FAIL (Screen A) This bit is set if the limit is exceeded in the upper adjacent channel. |
| 1 | ADJ LOWER FAIL (Screen A) This bit is set if the limit is exceeded in the lower adjacent channel. |
| 2 | ALT1 UPPER FAIL (Screen A) This bit is set if the limit is exceeded in the upper 1st alternate channel. |
| 3 | ALT1 LOWER FAIL (Screen A) This bit is set if the limit is exceeded in the lower 1st alternate channel. |
| 4 | ALT2 UPPER FAIL (Screen A) This bit is set if the limit is exceeded in the upper 2nd alternate channel. |
| 5 | ALT2 LOWER FAIL (Screen A) This bit is set if the limit is exceeded in the lower 2nd alternate channel. |
| 6 | not used |
| 7 | not used |
| 8 | ADJ UPPER FAIL (Screen B) This bit is set if the limit is exceeded in the upper adjacent channel. |
| 9 | ADJ LOWER FAIL (Screen B) This bit is set if the limit is exceeded in the lower adjacent channel. |
| 10 | ALT1 UPPER FAIL (Screen B) This bit is set if the limit is exceeded in the upper 1st alternate channel. |
| 11 | ALT1 LOWER FAIL (Screen B) This bit is set if the limit is exceeded in the lower 1st alternate channel. |
| 12 | ALT2 UPPER FAIL (Screen B) This bit is set if the limit is exceeded in the upper 2nd alternate channel. |
| 13 | ALT2 LOWER FAIL (Screen A) This bit is set if the limit is exceeded in the lower 2nd alternate channel. |
| 14 | not used |
| 15 | This bit is always 0. |

STATus QUEStionable:FREQuency Register

This register comprises information about the reference and local oscillator. It can be queried with commands `STATus:QUEStionable:FREQuency:CONDition?` and `"STATus:QUEStionable:FREQuency[:EVENT]?"`.

Table 5-6 Meaning of bits in STATus:QUEStionable:FREQuency register

| Bit No. | Meaning |
|---------|--|
| 0 | OVEN COLD This bit is set if the reference oscillator has not yet attained its operating temperature. 'OCXO' will then be displayed. |
| 1 | LO UNLocked (Screen A) This bit is set if the local oscillator no longer locks. 'LO unl' will then be displayed. |
| 2 | LO LEVei (Screen A) This bit is set if the level of the local oscillator is smaller than the nominal value. 'LO LVL' will then be displayed. |
| 3 | not used |
| 4 | not used |
| 5 | not used |
| 6 | not used |
| 7 | not used |
| 8 | not used |
| 9 | LO UNLocked (Screen B) This bit is set if the local oscillator no longer locks.' LO unl' will then be displayed. |
| 10 | LO LEVei (Screen B) This bit is set if the level of the local oscillator is smaller than the nominal value. 'LO LVL' will then be displayed. |
| 11 | not used |
| 12 | not used |
| 13 | not used |
| 14 | not used |
| 15 | This bit is always 0. |

STATus QUEStionable:LIMit Register

This register comprises information about the observance of limit lines. It can be queried with commands `STATus:QUEStionable:LIMit:CONDition?` and `STATus:QUEStionable:LIMit[:EVENT]?`.

Table 5-7 Meaning of bits in STATus:QUEStionable:LIMit register

| Bit No. | Meaning |
|---------|---|
| 0 | LIMit 1 FAIL This bit is set if limit line 1 is violated. |
| 1 | LIMit 2 FAIL This bit is set if limit line 2 is violated. |
| 2 | LIMit 3 FAIL This bit is set if limit line 3 is violated. |
| 3 | LIMit 4 FAIL This bit is set if limit line 4 is violated. |
| 4 | LIMit 5 FAIL This bit is set if limit line 5 is violated. |
| 5 | LIMit 6 FAIL This bit is set if limit line 6 is violated. |
| 6 | LIMit 7 FAIL This bit is set if limit line 7 is violated. |
| 7 | LIMit 8 FAIL This bit is set if limit line 8 is violated. |
| 8 | not used |
| 9 | not used |
| 10 | not used |
| 11 | not used |
| 12 | not used |
| 13 | not used |
| 14 | not used |
| 15 | This bit is always 0. |

STATus QUESTIONable:LMARgin Register

This register comprises information about the observance of limit margins. It can be queried with commands `STATus:QUESTIONable:LMARgin:CONDition?` and `"STATus:QUESTIONable:LMARgin[:EVENT]?"`.

Table 5-8 Meaning of bits in STATus:QUESTIONable:LMARgin register

| Bit No. | Meaning |
|---------|---|
| 0 | LMARgin 1 FAIL This bit is set if limit margin 1 is violated. |
| 1 | LMARgin 2 FAIL This bit is set if limit margin 2 is violated. |
| 2 | LMARgin 3 FAIL This bit is set if limit margin 3 is violated. |
| 3 | LMARgin 4 FAIL This bit is set if limit margin 4 is violated. |
| 4 | LMARgin 5 FAIL This bit is set if limit margin 5 is violated. |
| 5 | LMARgin 6 FAIL This bit is set if limit margin 1 is violated. |
| 6 | LMARgin 7 FAIL This bit is set if limit margin 7 is violated. |
| 7 | LMARgin 8 FAIL This bit is set if limit margin 8 is violated. |
| 8 | not used |
| 9 | not used |
| 10 | not used |
| 11 | not used |
| 12 | not used |
| 13 | not used |
| 14 | not used |
| 15 | This bit is always 0. |

STATus QUEStionable:POWer Register

This register comprises all information about possible overloads of the unit.

It can be queried with commands `STATus:QUEStionable :POWer:CONDition?` and `"STATus:QUEStionable:POWer [:EVENT]?"`.

Table 5-9 Meaning of bits in STATus:QUEStionable:POWer register

| Bit No. | Meaning |
|---------|---|
| 0 | OVERload (Screen A) This bit is set if the RF input is overloaded. 'OVLD' will then be displayed. |
| 1 | UNDERload (Screen A) - Option FSE-B7 This bit is set if, during measurements in vector analyzer mode without capture buffer used, the lower level limit in the IF path is violated. |
| 2 | IF_OVERload (Screen A) This bit is set if the IF path is overloaded. 'IFOVLD' will then be displayed. |
| 3 | not used |
| 4 | not used |
| 5 | not used |
| 6 | not used |
| 7 | not used |
| 8 | OVERload (Screen B) This bit is set if the RF input is overloaded. 'OVLD' will then be displayed. |
| 9 | UNDERload (Screen B) - Option FSE-B7 This bit is set if, during measurements without capture buffer used, the lower level limit in the IF path is violated. |
| 10 | IF_OVERload (Screen B) This bit is set if the IF path is overloaded. 'IFOVLD' will then be displayed. |
| 11 | not used |
| 12 | not used |
| 13 | not used |
| 14 | not used |
| 15 | This bit is always 0. |

STATus:QUESTionable:SYNC Register

This register comprises information about sync and burst events related to Vector Analyzer mode, option FSE-B7, and to GSM measurements, options FSE-K10/20/30 and FSE-K11/21/31). It can be queried with commands `STATus:QUESTionable:SYNC:CONDition?` and `"STATus:QUESTionable:SYNC[:EVENT]?"`.

Table 5-10 Meaning of bits in STATus:QUESTionable:SYNC register

| Bit No. | Meaning |
|---------|--|
| 0 | BURSt not found This bit is set if a burst was not found. |
| 1 | SYNC not found This bit is set if the sync sequence of midamble was not found. |
| 2 | No carrier This bit is set if the carrier power determined in the pre-measurement is 20 dB below of the expected signal power (options FSE-K10/ FSE-K11). |
| 3 | Carrier overload This bit is set if the carrier power determined in the pre-measurement is 4 dB above of the expected signal power (options FSE-K10/ FSE-K11). |
| 4 to 14 | not used |
| 15 | This bit is always 0. |

The 'SYNC not found' and 'BURSt not found' bits are set with all measurements evaluating this information. The bits are recalculated for each sweep so that they show the current status at the end of a sweep.

GSM measurements (options FSE-K10 and FSE-K11) carrying along the two bits synchronously with the sweep:

- CPW Carrier Power activated with 'Sync To Midamble' (*)
- PVT Power versus Time activated with 'Sync To Midamble' (*)
- PFE Phase/Frequency Error
- MAC Modulation Accuracy
- TAA Trigger AutoAdjust

* With GMSK modulation, the PVT and CPW measurements do not perform a burst search. The burst search is only active with 8PSK modulation (EDGE).

The Carrier Overload' and 'No Carrier' bits are reset at the beginning of each GSM measurement (options FSE-K10 and FSE-K11) and, if required, set at the end of the pre-measurement. If single-step measurements (CPW) are performed, the bits are set after the initial step and reset again at the beginning of the next.

GSM measurements with bit setting as required:

- CPW Carrier Power (first step only, measurement of full power)
- PVT Power versus Time (setting possible after each of the two pre-measurements)
- MOD Modulation Spectrum
- TRA Transient Spectrum (**)

** With FSE-K10 (mobile) and power coupling OFF selected, a pre-measurement is not performed. Measuring the carrier power is therefore not possible and so the two bits are not set.

STATus QUESTionable:TRANsducer Register

This register indicates that a transducer hold point is attained (bit 15) and what range is to be swept next (bit 0 to 10). The sweep can be continued with command `INITiate2:CONMeasure`.

It can be queried with commands `STATus:QUESTionable:TRANsducer:CONDition?` and `"STATus:QUESTionable:TRANsducer[:EVENT]?"`.

Table 5-11 Meaning of bits in STATus:QUESTionable:TRANsducer register

| Bit No. | Meaning |
|---------|---|
| 0 | Range 1 This bit is set when subrange 1 is attained. |
| 1 | Range 2 This bit is set when subrange 2 is attained. |
| 2 | Range 3 This bit is set when subrange 3 is attained. |
| 3 | Range 4 This bit is set when subrange 4 is attained. |
| 4 | Range 5 This bit is set when subrange 1 is attained. |
| 5 | Range 6 This bit is set when subrange 6 is attained. |
| 6 | Range 7 This bit is set when subrange 7 is attained. |
| 7 | Range 8 This bit is set when subrange 8 is attained. |
| 8 | Range 9 This bit is set when subrange 9 is attained. |
| 9 | Range 10 This bit is set when subrange 10 is attained. |
| 10 | not used |
| 11 | not used |
| 12 | not used |
| 13 | not used |
| 14 | Subrange limit This bit is set when the transducer is at the point of changeover from one range to another. |
| 15 | This bit is always 0. |

Application of the Status Reporting Systems

In order to be able to effectively use the status reporting system, the information contained there must be transmitted to the controller and further processed there. There are several methods which are represented in the following. Detailed program examples are to be found in chapter 7, Program Examples.

Service Request, Making Use of the Hierarchy Structure

Under certain circumstances, the instrument can send a service request (SRQ) to the controller. Usually this service request initiates an interrupt at the controller, to which the control program can react with corresponding actions. As evident from Fig. 5-3, an SRQ is always initiated if one or several of bits 2, 3, 4, 5 or 7 of the status byte are set and enabled in the SRE. Each of these bits combines the information of a further register, the error queue or the output buffer. The corresponding setting of the ENABLE parts of the status registers can achieve that arbitrary bits in an arbitrary status register initiate an SRQ. In order to make use of the possibilities of the service request, all bits should be set to "1" in enable registers SRE and ESE.

Examples (cf. Fig. 5-3 and chapter 7, Program Examples, as well):

Use of command "*OPC" to generate an SRQ at the end of a sweep.

- Set bit 0 in the ESE (Operation Complete)
- Set bit 5 in the SRE (ESB)?

After its settings have been completed, the instrument generates an SRQ.

The SRQ is the only possibility for the instrument to become active on its own. Each controller program should set the instrument such that a service request is initiated in the case of malfunction. The program should react appropriately to the service request. A detailed example for a service request routine is to be found in chapter 7, Program Examples.

Serial Poll

In a serial poll, just as with command "*STB", the status byte of an instrument is queried. However, the query is realized via interface messages and is thus clearly faster. The serial-poll method has already been defined in IEEE 488.1 and used to be the only standard possibility for different instruments to poll the status byte. The method also works with instruments which do not adhere to SCPI or IEEE 488.2.

The quick-BASIC command for executing a serial poll is "IBRSP()". Serial poll is mainly used to obtain a fast overview of the state of several instruments connected to the IEC bus.

Parallel Poll

In a parallel poll, up to eight instruments are simultaneously requested by the controller by means of a single command to transmit 1 bit of information each on the data lines, i.e., to set the data line allocated to each instrument to logically "0" or "1". By analogy to the SRE register which determines under which conditions an SRQ is generated, there is a parallel poll enable register (PPE) which is ANDed with the STB bit by bit as well considering bit 6. The results are ORed, the result is then sent (possibly inverted) as a response in the parallel poll of the controller. The result can also be queried without parallel poll by means of command "*IST".

The instrument first has to be set for the parallel poll using quick-BASIC command "IBPPC()". This command allocates a data line to the instrument and determines whether the response is to be inverted. The parallel poll itself is executed using "IBRPP()".

The parallel-poll method is mainly used in order to quickly find out after an SRQ which instrument has sent the service request if there are many instruments connected to the IEC bus. To this effect, SRE and PPE must be set to the same value. A detailed example as to the parallel poll is to be found in chapter 7, Program Examples.

Query by Means of Commands

Each part of every status register can be read by means of queries. The individual commands are indicated in the detailed description of the registers. What is returned is always a number which represents the bit pattern of the register queried. Evaluating this number is effected by the controller program.

Queries are usually used after an SRQ in order to obtain more detailed information on the cause of the SRQ.

Error-Queue Query

Each error state in the instrument leads to an entry in the error queue. The entries of the error queue are detailed plain-text error messages which can be looked at in the ERROR menu via manual control or queried via the IEC bus using command "SYSTem:ERRor?". Each call of "SYSTem:ERRor?" provides an entry from the error queue. If no error messages are stored there any more, the instrument responds with 0, "No error".

The error queue should be queried after every SRQ in the controller program as the entries describe the cause of an error more precisely than the status registers. Especially in the test phase of a controller program the error queue should be queried regularly since faulty commands from the controller to the instrument are recorded there as well.

Resetting Values of the Status Reporting System

Table 5-12 comprises the different commands and events causing the status reporting system to be reset. None of the commands, except for *RST and SYSTem:PRESet influences the functional instrument settings. In particular, DCL does not change the instrument settings.

Table 5-12 Resetting instrument functions

| Event | Switching on supply voltage | | DCL,SDC (Device Clear, Selected Device Clear) | *RST or SYSTem:PRESet | STATus:PRESet | *CLS |
|--|-----------------------------|-----|--|--------------------------|---------------|------|
| | Power-On-Status-Clear | | | | | |
| | 0 | 1 | | | | |
| Clear STB,ESR | — | yes | — | — | — | yes |
| Clear SRE,ESE | — | yes | — | — | — | — |
| Clear PPE | — | yes | — | — | — | — |
| Clear EVENTt parts of the registers | — | yes | — | — | — | yes |
| Clear Enable parts of all OPERation and QUEStionable registers, Fill Enable parts of all other registers with "1". | — | yes | — | — | yes | — |
| Fill PTRansition parts with "1", Clear NTRansition parts | — | yes | — | — | yes | — |
| Clear error queue | yes | yes | — | — | — | yes |
| Clear output buffer | yes | yes | yes | 1) | 1) | 1) |
| Clear command processing and input buffer | yes | yes | yes | — | — | — |

1) Every command being the first in a command line, i.e., immediately following a <PROGRAM MESSAGE TERMINATOR> clears the output buffer.

Contents - Chapter 6 "Remote Control - Description of Commands"

| | |
|--|--------------|
| 6 Description of Commands | 6.1 |
| Notation | 6.1 |
| Common Commands | 6.4 |
| ABORt Subsystem | 6.8 |
| CALCulate Subsystem | 6.8 |
| CALCulate:DELTamarker Subsystem | 6.9 |
| CALCulate:DLINe Subsystem | 6.15 |
| CALCulate:FEED Subsystem | 6.18 |
| CALCulate:FORMat and CALCulate:FSK Subsystems..... | 6.19 |
| CALCulate:LIMit Subsystem | 6.20 |
| CALCulate:MARKer Subsystem | 6.36 |
| CALCulate:MATH Subsystem | 6.61 |
| CALCulate:X and CALCulate:UNIT Subsystem | 6.62 |
| CALibration Subsystem | 6.63 |
| CONFigure Subsystem | 6.65 |
| CONFigure:BTS Subsystem..... | 6.65 |
| CONFigure:BURSt Subsystem..... | 6.73 |
| CONFigure:MS Subsystem | 6.77 |
| CONFigure:SPECTrum Subsystem..... | 6.85 |
| CONFigure:SPURious Subsystem | 6.87 |
| DIAGnostic Subsystem | 6.89 |
| DISPlay Subsystem | 6.91 |
| FETCh Subsystem | 6.101 |
| FETCh:BURSt Subsystem | 6.101 |
| FETCh:PTEMplate Subsystem..... | 6.111 |
| FETCh:SPECTrum Subsystem | 6.112 |
| FETCh:SPURious Subsystem..... | 6.115 |
| FORMat Subsystem | 6.117 |
| HCOPy Subsystem | 6.119 |
| INITiate Subsystem | 6.125 |
| INPut Subsystem | 6.127 |
| INSTrument Subsystem | 6.130 |
| MMEMory Subsystem | 6.132 |
| OUTPut Subsystem | 6.143 |
| READ Subsystem | 6.145 |
| READ:BURSt Subsystem | 6.145 |
| READ:SPECTrum Subsystem | 6.159 |
| READ:SPURious Subsystem | 6.161 |

SENSE Subsystem 6.163

- SENSE:ADEMod Subsystem 6.163
- SENSE:AVERage Subsystem 6.165
- SENSE:BANDwidth Subsystem 6.167
- SENSE:CORRection-Subsystem 6.171
- SENSE:DETEctor Subsystem 6.181
- SENSE:DDEMod Subsystem 6.182
- SENSE:FILTEr Subsystem 6.190
- SENSE:FREQuency Subsystem 6.193
- SENSE:MIXer - Subsystem 6.197
- SENSE:MSUMmary Subsystem 6.201
- SENSE:POWEr Subsystem 6.203
- SENSE:ROSCillator Subsystem 6.206
- SENSE:SWEEp Subsystem 6.207
- SENSE:TV Subsystem 6.211

SOURce Subsystem 6.212

STATus Subsystem 6.214

SYSTem Subsystem 6.226

TRACe Subsystem 6.233

TRIGger Subsystem 6.235

UNIT Subsystem 6.240

Alphabetical List of Commands 6.241

Table of Softkeys with IEC/IEEE-Bus Command Assignment 6.259

- Basic Instrument - Signal Analysis Mode 6.259
 - FREQUENCY Key Group 6.259
 - LEVEL Key Group 6.261
 - INPUT Key 6.262
 - MARKER Key Group 6.263
 - LINES Key Group 6.267
 - TRACE Key Group 6.269
 - SWEEP Key Group 6.271
- Basic Instrument - General Device Settings 6.274
 - DATA VARIATION Key Group 6.274
 - SYSTEM Key Group 6.274
 - CONFIGURATION Key Group 6.277
 - STATUS Key Group 6.279
 - HARDCOPY Key Group 6.280
 - MEMORY Key Group 6.281
 - USER Key 6.283
- Operating Mode Vector-Signal Analyzer (Option FSE-B7) 6.284
 - CONFIGURATION Key Group - Digital Demodulation 6.284
 - CONFIGURATION Key Group - Analog Demodulation 6.288
 - FREQUENCY Key Group 6.289
 - LEVEL Key Group 6.290
 - INPUT Key 6.291
 - MARKER Key Group 6.291
 - LINES Key Group 6.293

| | |
|---|-------|
| TRACE Key Group | 6.294 |
| SWEEP Key Group | 6.295 |
| TRIGGER Key Group - Digital Demodulation | 6.295 |
| TRIGGER Key Group - Analog Demodulation | 6.296 |
| Operating Mode Tracking Generator (Option FSE-B8 to B11)..... | 6.297 |
| CONFIGURATION Key Group | 6.297 |
| Operating Mode TV Demodulation (Option FSE-B3) | 6.298 |
| CONFIGURATION Key Group | 6.298 |
| SWEEP Key Group | 6.298 |
| Operating Mode GSM BTS Analyzer (Option FSE-K11) | 6.299 |
| CONFIGURATION Key Group | 6.299 |
| Operating Mode GSM MS Analyzer (Option FSE-K10)..... | 6.309 |
| CONFIGURATION Key Group | 6.309 |
| External Mixer Output (Option FSE-B21) | 6.319 |
| INPUT Key Group..... | 6.319 |

6 Description of Commands

Notation

In the following sections, all commands implemented in the instrument are first listed in tables and then described in detail, separated according to the command system. The notation corresponds to the one of the SCPI standards to a large extent. The SCPI conformity information can be taken from the individual description of the commands.

Table of Commands

| | |
|------------|---|
| Command: | In the command column, the table provides an overview of the commands and their hierarchical arrangement (see indentations). |
| Parameter: | The parameter column indicates the requested parameters together with their specified range. |
| Unit: | The unit column indicates the basic unit of the physical parameters. |
| Remark: | In the remark column an indication is made on: <ul style="list-style-type: none"> – whether the command does not have a query form, – whether the command has only one query form – whether this command is implemented only with a certain option of the instrument |

Indentations

The different levels of the SCPI command hierarchy are represented in the table by means of indentations to the right. The lower the level is, the farther the indentation to the right is. Please observe that the complete notation of the command always includes the higher levels as well.

Example: `:SENSE:FREQUENCY:CENTER` is represented in the table as follows:

| | |
|-------------------------|--------------|
| <code>:SENSe</code> | first level |
| <code>:FREQuency</code> | second level |
| <code>:CENTer</code> | third level |

Individual description

In the individual description, the complete notation of the command is given. An example for each command, the *RST value and the SCPI information is written out at the end of the individual description.

The modes for which a command can be used are indicated by the following abbreviations:

| | |
|------|---|
| A | Spectrum analysis |
| A-F | Spectrum analysis - frequency domain only |
| A-Z | Spectrum analysis - time domain only (zero span) |
| VA | Vector signal analysis (option FSE-B7) |
| VA-D | Vector signal analysis - digital demodulation (option FSE-B7) |
| VA-A | Vector signal analysis - analog demodulation (option FSE-B7) |
| BTS | GSM BTS analysis (option FSE-K11) |
| MS | GSM MS analysis (option FSE-K10) |

Note: *The spectrum analysis (analyzer) mode is implemented in the basic unit. For the other modes, the corresponding options are required.*

Upper/lower case notation Upper/lower case letters serve to mark the long or short form of the key words of a command in the description (see Chapter 5). The instrument itself does not distinguish between upper and lower case letters.

Special characters | A selection of key words with an identical effect exists for several commands. These key words are indicated in the same line, they are separated by a vertical stroke. Only one of these key words has to be indicated in the header of the command. The effect of the command is independent of which of the key words is indicated.

Example: `SENSe:FREQuency:CW|:FIXed`

The two following commands of identical meaning can be formed. They set the frequency of the constantly frequent signal to 1 kHz:

`SENSe:FREQuency:CW 1E3 = SENSe:FREQuency:FIXed 1E3`

A vertical stroke in indicating the parameters marks alternative possibilities in the sense of "or". The effect of the command is different, depending on which parameter is entered.

Example: Selection of the parameters for the command

`INPut:COUPling AC | DC`

If parameter AC is selected, only the AC content is fed through, in the case of DC, the DC as well as the AC content.

[] Key words in square brackets can be omitted when composing the header (cf. Chapter 5, Section "Optional Keywords"). The full command length must be accepted by the instrument for reasons of compatibility with the SCPI standards.

Parameters in square brackets can optionally be incorporated in the command or omitted as well.

{ } Parameters in braces can optionally be incorporated in the command either not at all, once or several times.

Description of parameters Due to the standardization, the parameter section of SCPI commands consists always of the same syntactical elements. SCPI has specified a series of definitions therefore, which are used in the tables of commands. In the tables, these established definitions are indicated in angled brackets (<...>) and will be briefly explained in the following (see also Chapter 5, Section "Parameters").

<Boolean> This indication refers to parameters which can adopt two states, "on" and "off". The "off" state may either be indicated by the keyword **OFF** or by the numeric value 0, the "on" state is indicated by **ON** or any numeric value other than zero. Parameter queries are always returned the numeric value 0 or 1.

<numeric_value>
 <num> These indications mark parameters which may be entered as numeric values or be set using specific keywords (character data).
 The keywords given below are permitted:
MINimum This keyword sets the parameter to the smallest possible value.
MAXimum This keyword sets the parameter to the largest possible value.
DEFault This keyword is used to reset the parameter to its default value.
UP This keyword increments the parameter value.
DOWN This keyword decrements the parameter.
The numeric values associated to MAXimum/MINimum/DEFault can be queried by adding the corresponding keywords to the command. They must be entered following the quotation mark.
Example:SENSe:FREQuency:CENTer? MAXimum
returns the maximum possible numeric value of the center frequency as result.

<arbitrary block program data>
This keyword is provided for commands the parameters of which consist of a binary data block.

Common Commands

The common commands are taken from the IEEE 488.2 (IEC 625-2) standard. Some commands have the same effect on different devices. The headers of these commands consist of an asterisk "*" followed by three letters. Many common commands refer to the status reporting system which is described in detail in Chapter 5.

| Command | Designation | Parameter | Remark |
|---------|-------------------------------|-----------|------------|
| *CAL? | Calibration Query | | query only |
| *CLS | Clear Status | | no query |
| *ESE | Event Status Enable | 0 to 255 | |
| *ESR? | Standard Event Status Query | 0 to 255 | query only |
| *IDN? | Identification Query | <string> | query only |
| *IST? | Individual Status Query | 0 to 255 | query only |
| *OPC | Operation Complete | | |
| *OPT? | Option Identification Query | | query only |
| *PCB | Pass Control Back | 0 to 30 | no query |
| *PRE | Parallel Poll Register Enable | 0 to 255 | |
| *PSC | Power On Status Clear | 0 1 | |
| *RST | Reset | | no query |
| *SRE | Service Request Enable | 0 to 255 | |
| *STB? | Status Byte Query | | query only |
| *TRG | Trigger | | no query |
| *TST? | Self Test Query | | query only |
| *WAI | Wait to continue | | no query |

*CAL?

CALIBRATION QUERY triggers a calibration of the instrument and subsequently query the calibration status. Any responses > 0 indicate errors.

*CLS

CLEAR STATUS sets the status byte (STB), the standard event register (ESR) and the EVENT-part of the QUESTIONable and the OPERATION register to zero. The command does not alter the mask and transition parts of the registers. It clears the output buffer.

***ESE 0 to 255**

EVENT STATUS ENABLE sets the event status enable register to the value indicated. Query *ESE? returns the contents of the event status enable register in decimal form.

***ESR?**

STANDARD EVENT STATUS QUERY returns the contents of the event status register in decimal form (0 to 255) and subsequently sets the register to zero.

***IDN?**

IDENTIFICATION QUERY queries the instrument identification.

The instrument identification consists of the following elements which are separated by commas:

Manufacturer

Device (analyzer model)

Serial number of the instrument

Firmware version number

Example: "Rohde&Schwarz, FSEA30, 825082/007, 1.67"

***IST?**

INDIVIDUAL STATUS QUERY returns the contents of the IST flag in decimal form (0 | 1). The IST flag is the status bit which is sent during a parallel poll (cf. Chapter 5).

***OPC**

OPERATION COMPLETE sets bit 0 in the event status register when all preceding commands have been executed. This bit can be used to initiate a service request (cf. Chapter 5).

***OPC?**

OPERATION COMPLETE QUERY writes message "1" into the output buffer as soon as all preceding commands have been executed (cf. Chapter 5).

***PSC 0 | 1**

POWER ON STATUS CLEAR determines whether the contents of the ENABLE registers is maintained or reset in switching on.

*PSC = 0 causes the contents of the status registers to be maintained. Thus a service request can be triggered in switching on in the case of a corresponding configuration of status registers ESE and SRE.

*PSC \neq 0 resets the registers.

Query *PSC? reads out the contents of the power-on-status-clear flag. The response can be 0 or 1.

***RST**

RESET sets the instrument to a defined default status. The command essentially corresponds to pressing the [PRESET] key. The default setting is indicated in the description of the commands.

***SRE 0 to 255**

SERVICE REQUEST ENABLE sets the service request enable register to the value indicated. Bit 6 (MSS mask bit) remains 0. This command determines under which conditions a service request is triggered. Query *SRE? reads the contents of the service request enable register in decimal form. Bit 6 is always 0.

***STB?**

READ STATUS BYTE QUERY reads out the contents of the status byte in decimal form.

***TRG**

TRIGGER triggers a measurement. This command corresponds to `INITiate:IMMediate` (cf. Section "TRIGger subsystem", as well).

***TST?**

SELF TEST QUERY triggers all selftests of the instrument and outputs an error code in decimal form.

***WAI**

WAIT-to-CONTINUE only permits the servicing of the subsequent commands after all preceding commands have been executed and all signals have settled (cf. Chapter 5 and "*OPC" as well).

ABORt Subsystem

The ABORt subsystem contains the commands for aborting triggered actions. An action can be triggered again immediately after being aborted. All commands trigger events which is why they are not assigned any *RST value.

| COMMAND | PARAMETERS | UNIT | COMMENT |
|---------|------------|------|----------|
| ABORt | -- | -- | no query |

:ABORt

This command aborts a current measurement and resets the trigger system.

Example: "ABOR ; INIT : IMM "

Features: *RST value: 0
 SCPI: conforming

Modes: A, VA, BTS, MS

CALCulate Subsystem

The CALCulate subsystem contains commands for converting instrument data, transforming and carrying out corrections. These functions are carried out subsequent to data acquisition, i.e., following the SENSE subsystem.

In the split-screen representation, a distinction is made between CALCulate1 and CALCulate2:

CALCulate1 \triangleq screen A;

CALCulate2 \triangleq screen B

For setting REAL/IMAG PART in Vector Analyzer mode a distinction is also made between CALCulate3 and CALCulate4 in the split-screen representation:

CALCulate3 \triangleq screen C;

CALCulate4 \triangleq screen D

:CALCulate<1|2>:DELTamarker<1 to 4>:MODE ABSolute | RELative

This command switches over between relative and absolute input of frequency of the delta marker.

Example: " :CALC:DELT:MODE ABS "

Features: *RST value: REL
SCPI: device-specific

Modes: A, VA, BTS, MS

In the RELative mode, the frequency of the delta marker is programmed relative to the reference marker. In the ABSolute mode, the frequency is defined by the absolute values.

:CALCulate<1|2>:DELTamarker<1 to 4>:AOFF

This command switches off all active delta markers.

Example: " :CALC:DELT:AOFF "

Features: *RST value: -
SCPI: device-specific

Modes: A, VA, BTS, MS

:CALCulate<1|2>:DELTamarker<1 to 4>:TRACe 1 to 4

This command assigns the selected delta marker to the indicated measuring curve.

Example: " :CALC:DELT3:TRAC 2 "

Features: *RST value: -
SCPI: device-specific

Modes: A, VA, BTS, MS

:CALCulate<1|2>:DELTamarker<1 to 4>:X 0 to MAX (frequency | sweep time | symbols)

This command positions the selected delta marker to the indicated frequency (span > 0) or time (span = 0). The query always returns the absolute value of frequency or time.

Example: " :CALC:DELT:X 10.7MHz "

Features: *RST value: -
SCPI: device-specific

Modes: A, VA, BTS, MS

The SYM unit is only valid in Vector Signal Analysis mode.

:CALCulate<1|2>:DELTamarker<1 to 4>:X:RELative?

This command queries the frequency (span > 0) or time (span = 0) of the selected delta marker relative to the reference marker.

Example: " :CALC:DELT:X:REL? "

Features: *RST value: -
SCPI: device-specific

Modes: A, VA, BTS, MS

:CALCulate<1|2>:DELTamarker<1 to 4>:Y?

This command queries the value of the selected marker.

Example: " : CALC : DELT : Y ? "

Features: *RST value: -
SCPI: device-specific

Modes: A, VA, BTS, MS

In complex presentations (vector signal analysis - polar diagrams), the real and the imaginary component as well as magnitude and phase are output separated by a comma.

:CALCulate<1|2>:DELTamarker<1 to 4>:MAXimum[:PEAK]

This command positions the delta marker to the current maximum value in the trace memory.

Example: " : CALC : DELT : MAX "

Features: *RST value: -
SCPI: device-specific

Modes: A, VA, BTS, MS

This command is an event which is why it is not assigned an *RST value and has no query.

:CALCulate<1|2>:DELTamarker<1 to 4>:MAXimum:APEak

This command positions the delta marker to the maximum absolute value of the trace.

Example: " : CALC : DELT : MAX : APE "

Features: *RST value: -
SCPI: device-specific

Modes: VA

This command is an event which is why it is not assigned an *RST value and has no query.

:CALCulate<1|2>:DELTamarker<1 to 4>:MAXimum:NEXT

This command positions the delta marker to the next smaller maximum value in the trace memory.

Example: " : CALC : DELT : MAX : NEXT "

Features: *RST value: -
SCPI: device-specific

Modes: A, BTS, MS

This command is an event which is why it is not assigned an *RST value and has no query.

:CALCulate<1|2>:DELTamarker<1 to 4>:MAXimum:RIGHT

This command positions the delta marker to the next smaller maximum value to the right of the current value (i.e., in ascending X direction) in the trace memory.

Example: " : CALC : DELT : MAX : RIGH "

Features: *RST value: -
SCPI: device-specific

Modes: A, BTS, MS

This command is an event which is why it is not assigned an *RST value and has no query.

:CALCulate<1|2>:DELTamarker<1 to 4>:MAXimum:LEFT

This command positions the delta marker to the next smaller maximum value to the left of the current value (i.e., in descending X direction) in the trace memory.

Example: " : CALC : DELT : MAX : LEFT "

Features: *RST value: -
SCPI: device-specific

Modes: A, BTS, MS

Modes: R, A

This command is an event which is why it is not assigned an *RST value and has no query.

:CALCulate<1|2>:DELTamarker<1 to 4>:MINimum[:PEAK]

This command positions the delta marker to the current minimum value in the trace memory.

Example: " : CALC : DELT : MIN "

Features: *RST value: -
SCPI: device-specific

Modes: A, VA, BTS, MS

This command is an event which is why it is not assigned an *RST value and has no query.

:CALCulate<1|2>:DELTamarker<1 to 4>:MINimum:NEXT

This command positions the delta marker to the next higher minimum value in the trace memory.

Example: " : CALC : DELT : MIN : NEXT "

Features: *RST value: -
SCPI: device-specific

Modes: A, BTS, MS

This command is an event which is why it is not assigned an *RST value and has no query.

:CALCulate<1|2>:DELTamarker<1 to 4>:MINimum:RIGHT

This command positions the delta marker to the next higher minimum value to the right of the current value (ie in ascending X direction).

Example: " : CALC : DELT : MIN : RIGH "

Features: *RST value: -
SCPI: device-specific

Modes: A, BTS, MS

This command is an event which is why it is not assigned an *RST value and has no query.

:CALCulate<1|2>:DELTamarker<1 to 4>:MINimum:LEFT

This command positions the delta marker to the next higher minimum value to the left of the current value (ie in descending X direction).

Example: " : CALC : DELT : MIN : LEFT "

Features: *RST value: -
SCPI: device-specific

Modes: A, BTS, MS

This command is an event which is why it is not assigned an *RST value and has no query.

:CALCulate<1|2>:DELTamarker<1 to 4>:FUNCTION:FIXed[:STATe] ON | OFF

This command switches the relative measurement to a fixed reference value on or off.

Example: " :CALC:DELT:FUNC:FIX ON"

Features: *RST value: OFF
SCPI: device-specific.

Modes: A, VA-D, BTS, MS

The reference value is independent of the current trace.

:CALCulate<1|2>:DELTamarker<1 to 4>:FUNCTION:FIXed:RPOint:Y <numeric_value>

This command defines a new fixed reference value for the relative measurement.

Example: " :CALC:DELT:FUNC:FIX:RPO:Y -10dBm"

Features: *RST value: - (FUNCTION:FIXed[:STATe] is set to OFF)
SCPI: device-specific

Modes: A, VA

The reference value is independent of the current trace.

:CALCulate<1|2>:DELTamarker<1 to 4>:FUNCTION:FIXed:RPOint:Y:OFFSet <numeric_value>

This command defines an additional level offset for the relative measurement.

Example: " :CALC:DELT:FUNC:FIX:RPO:Y:OFFS 10dB"

Features: *RST value: 0 dB
SCPI: device-specific

Modes: A, VA

The level offset is included in the output of the level value.

:CALCulate<1|2>:DELTamarker<1 to 4>:FUNCTION:FIXed:RPOint:X <numeric_value>

This command defines the new fixed reference frequency, time or symbols for the relative measurement.

Example: " :CALC:DELT:FUNC:FIX:RPO:X 10.7MHz"

Features: *RST value: - (FUNCTION:FIXed[:STATe] is set to OFF)
SCPI: device-specific

Mode: A

The reference value is independent of the current trace. With span = 0, the reference time, otherwise the reference frequency is defined.

:CALCulate<1|2>:DELTamarker<1 to 4>:FUNCTION:PNOise[:STATe] ON | OFF

This command switches the measurement of the phase noise on or off.

Example: " :CALC:DELT:FUNC:PNO ON"

Features: *RST value: OFF
SCPI: device-specific

Mode: A

When the phase noise is measured, the correction values for the bandwidth and the log amplifier are automatically considered. The measurement uses the reference values defined by
FUNCTION:FIXed:RPOint:X or :Y.

:CALCulate<1|2>:DELTamarker<1 to 4>:FUNCTION:PNOise:RESult?

This command queries the result of the phase noise measurement.

Example: " :CALC:DELT:FUNC:PNO:RES? "

Features: *RST value: -
SCPI: device-specific

Modes: A, BTS, MS

This command is only a query which is why it is not assigned an *RST value.

:CALCulate<1|2>:DELTamarker<1 to 4>:STEP[:INCRement] <numeric_value>

This command defines the delta marker step width.

Example: " :CALC:DELT:STEP 10kHz " (frequency domain)
" :CALC:DELT:STEP 5ms " (time domain)

Features: *RST value: - (STEP is set to AUTO)
SCPI: device-specific

Mode: A

:CALCulate<1|2>:DELTamarker<1 to 4>:STEP:AUTO ON | OFF

This command switches the automatic adaptation of the marker step width on or off.

Example: " :CALC:DELT:STEP:AUTO OFF "

Features: *RST value: ON
SCPI: device-specific

Mode: A

With AUTO ON, the step width is 10% of the span.

CALCulate:DLINe Subsystem

The CALCulate:DLINe subsystem checks the display lines in the instrument, i.e., the level, frequency and time lines (depending on the X-axis) as well as threshold and reference lines.

| COMMAND | PARAMETERS | UNIT | COMMENT |
|-------------------------------|-----------------|--|---------|
| CALCulate<1 2> :DLINe<1 2> | <numeric_value> | DBM DB DEG RAD S HZ PCT | |
| :STATe | <Boolean> | | |
| :THReshold | <numeric_value> | DBM DB DEG RAD S HZ PCT | |
| :STATe | <Boolean> | | |
| :CTHReshold | <numeric_value> | DBM DB DEG RAD S HZ PCT | |
| :STATe | <Boolean> | | |
| :RLINe | <numeric_value> | DBM DB DEG RAD S HZ PCT | |
| :STATe | <Boolean> | | |
| :FLINe<1 2> | <numeric_value> | HZ | |
| :STATe | <Boolean> | | |
| :TLINe<1 2> | <numeric_value> | S SYM | |
| :STATe | <Boolean> | | |

:CALCulate<1|2>:DLINe<1|2> MINimum to MAXimum (depending on current unit)

This command defines the position of the display line.

Example: " :CALC:DLIN -20dBm "

Features: *RST value: - (STATe to OFF)
SCPI: device-specific

Modes: A, VA, BTS, MS

The display lines mark the given level in the display. The units DEG, RAD, S, and HZ are only valid in conjunction with option Vector Signal Analysis, FSE-B7.

:CALCulate<1|2>:DLINe<1|2>:STATe ON | OFF

This command switches the display line on or off.

Example: " :CALC:DLIN2:STAT OFF "

Features: *RST value: OFF
SCPI: device-specific

Modes: A, VA, BTS, MS

:CALCulate<1|2>:THReshold MINimum to MAXimum (depending on current unit)

This command defines the position of the thresholds.

Example: " :CALC:THR -82dBm"

Features: *RST value: - (STATe to OFF)
SCPI: device-specific

Modes: A, VA, BTS, MS

For marker scan functions MAX PEAK, NEXT PEAK etc., the threshold serves as the lowest limit for maximum or minimum search. The units DEG, RAD, S, and HZ are only valid in conjunction with option Vector Signal Analysis, FSE-B7.

:CALCulate<1|2>:THReshold:STATe ON | OFF

This command switches the threshold on or off.

Example: " :CALC:THR:STAT ON"

Features: *RST value: OFF
SCPI: device-specific

Modes: A, VA, BTS, MS

:CALCulate<1|2>:CTHReshold MINimum to MAXimum (depending on the current unit)

This command defines the position of a threshold line (base line), below which all measured values are cleared.

Example: " :CALC:CTHR -82dBm"

Features: *RST value: - (STATe to OFF)
SCPI: device-specific

Mode: A, VA, BTS, MS

The units DEG, RAD, S, and HZ are only valid in conjunction with option Vector Signal Analysis, FSE-B7.

:CALCulate<1|2>:CTHReshold:STATe ON | OFF

This command is for switching on or off the threshold line (base line), below which all measured values are cleared.

Example: " :CALC:CTHR:STAT ON"

Features: *RST value: OFF
SCPI: device-specific

Mode: A, VA, BTS, MS

:CALCulate<1|2>:RLINE MINimum to MAXimum (depending on the current unit)

This command defines the position of the reference line.

Example: " :CALC:RLIN -10dBm"

Features: *RST value: - (STATe to OFF)
SCPI: device-specific

Modes: A, VA, BTS, MS

The reference line serves as a reference for the arithmetic operation of traces. The units DEG, RAD, S, and HZ are only valid in conjunction with option Vector Signal Analysis, FSE-B7.

:CALCulate<1|2>:RLINe:STATe ON | OFF

This command switches the reference line on or off.

Example: " :CALC:RLIN:STAT ON "

Features: *RST value: OFF
SCPI: device-specific

Modes: A, VA, BTS, MS

:CALCulate<1|2>:FLINe<1|2> 0 GHz to f_{\max}

This command defines the position of the frequency lines.

Example: " :CALC:FLIN2 120MHz "

Features: *RST value: - (STATe to OFF)
SCPI: device-specific

Modes: A-F, VA, BTS, MS

The frequency lines mark the given frequencies in the display. Frequency lines are only valid for a SPAN >0.

:CALCulate<1|2>:FLINe<1|2>:STATe ON | OFF

This command switches the frequency line on or off.

Example: " :CALC:FLIN2:STAT ON "

Features: *RST value: OFF
SCPI: device-specific

Modes: A-F, VA, BTS, MS

:CALCulate<1|2>:TLINe<1|2> 0 to 1000s

This command defines the position of the time lines.

Example: " :CALC:TLIN 10ms "

Features: *RST value: - (STATe to OFF)
SCPI: device-specific

Modes: A-Z, VA, BTS, MS

The time lines mark the given times in the display. Time lines are only valid for a SPAN = 0.

:CALCulate<1|2>:TLINe<1|2>:STATe ON | OFF

This command switches the time line on or off.

Example: " :CALC:TLIN2:STAT ON "

Features: *RST value: OFF
SCPI: device-specific

Modes: A-Z, VA, BTS, MS

CALCulate:FORMat and CALCulate:FSK Subsystems

The CALCulate:FORMat and CALCulate:FSK subsystems determine further processing and conversion of measured data in operating mode vector signal analysis.

This sub system is only valid in connection with option FSE-B7, Vector Signal Analysis.

| COMMAND | PARAMETERS | UNIT | COMMENT |
|----------------------------------|--|------|------------------------|
| CALCulate<1 2> :FORMat | MAGNitude PHASe UPHase RIMag FREQuency IEYE QEYE TEYE FEYE COMP CONS | | Vector Signal Analysis |
| :FSK :DEViation :REFerence | <numeric_value> | HZ | Vector Signal Analysis |

:CALCulate<1|2>:FORMat MAGNitude | PHASe | UPHase | RIMag | FREQuency | IEYE | QEYE |
TEYE | FEYE | COMP | CONS

This command defines the display of the traces.

Example: " :CALC:FORM CONS "

Features: *RST value: MAGNitude
SCPI: conforming

Mode: VA-D

The availability of the parameters depends on the selected data (see command :CALCulate:FEED).

Available for selection measurement signal, reference signal and modulation error
(CALCulate:FEED `XTIM:DDEM:MEAS`, `XTIM:DDEM:REF`, `XTIM:DDEM:ERR:MPH`):

MAGNitude Display of the magnitude in the time domain (only available for settings :CALCulate:FEED `XTIM:DDEM:ERR:MPH` (error signal) or `XTIM:DDEM:MEAS` (measurement signal) or `XTIM:DDEM:REF` (reference signal)

PHASe | UPHase Display of the phase in the time domain with or without ("unwrapped") limitation to $\pm 180^\circ$

RIMag Display of the time characteristic of inphase and quadrature component

FREQuency Display of the frequency response in the time domain

COMP Display of the polar vector diagram (complex)

CONS Display of the polar vector diagram (constellation)

Available for selection measurement signal and reference signal (CALCulate:FEED `XTIM:DDEM:MEAS`, `XTIM:DDEM:REF`):

IEYE | QEYE Eye diagram of the inphase or quadrature component

TEYE Display of the trellis diagram

FEYE Eye diagram of FSK modulation

:CALCulate<1|2>:FSK:DEViation:REFerence <numeric_value>

This command defines the reference value of the frequency deviation for FSK modulation.

Example: " :CALC:FSK:DEV:REF 20kHz "

Features: *RST value: -
SCPI: device-specific

Mode: VA-D

CALCulate:LIMit Subsystem

The CALCulate:LIMit subsystem comprises the limit lines and the corresponding limit checks. Limit lines can be defined as upper and lower limit lines. The individual values of the limit lines correspond to the values of the X-axis (CONTRol) which have to have the same number.

| COMMAND | PARAMETERS | UNIT | COMMENT |
|----------------|---|-------------------------------------|------------------------|
| CALCulate<1 2> | | | |
| :LIMit<1 to 8> | | | Query only |
| :ACTive? | <numeric_value> | | |
| :TRACe | <Boolean> | -- | |
| :STATe | DBM DBPW DBPT WATT DBUV DBMV VOLT DBUA AMPere DB DBUV_MHZ DBMV_MHZ DBUA_MHZ DBUV_M DBUA_M DBUV_MMHZ DBUA_MMHZ DEG RAD S HZ PCT UNITLESS | | |
| :UNIT | | | |
| CATalog? | | | Query only |
| :CONTRol | <numeric_value>,<numeric_value>.. | HZ S SYM | |
| [:DATA] | FREQuency TIME | | |
| :DOMain | <numeric_value> | HZ S SYM | |
| :OFFSet | RELative ABSolute | | |
| :MODE | | | |
| :UNIT | S SYM | | |
| [:TIME] | <numeric_value> | HZ S SYM | Vector Signal Analysis |
| :SHIFt | LINear LOGarithmic | | |
| :SPACing | | | |
| :UPPer | <numeric_value>,<numeric_value>.. | DBM DB DEG RAD S HZ PCT | |
| [:DATA] | <Boolean> | -- | |
| :STATe | <numeric_value> | DB DEG RAD S HZ PCT | |
| :OFFSet | <numeric_value> | DB DEG RAD S HZ PCT | |
| :MARGin | RELative ABSolute | -- | |
| :MODE | <numeric_value> | DB DEG RAD S HZ PCT | |
| :SHIFt | LINear LOGarithmic | | |
| :SPACing | | | |
| :LOWer | <numeric_value>,<numeric_value>.. | DBM DB DEG RAD S HZ PCT | |
| [:DATA] | <Boolean> | -- | |
| :STATe | <numeric_value> | DB DEG RAD S HZ PCT | |
| :OFFSet | <numeric_value> | DB DEG RAD S HZ PCT | |
| :MARGin | RELative ABSolute | -- | |
| :MODE | <numeric_value> | DB DEG RAD S HZ PCT | |
| :SHIFt | LINear LOGarithmic | | |
| :SPACing | | | |
| :FAIL? | | -- | query only |
| :CLEar | -- | -- | |
| [:IMMEDIATE] | | | no query |

| COMMAND | PARAMETERS | UNIT | COMMENT |
|---|---|------------------------|--|
| CALCulate<1 2> :LIMit<1 to 8> :COMMeNt :COpy :NAme :DELete :BURSt :PTEMplate? :POWEr? :PFERror? :MACCuracy? :SPEctrum :MODulation? :FAILs? :EXCeptions? :SWITChing? :FAILs? :SPURious? :FAILs? :MARGin :ACPower [:STATe] :ACHannel :STATe :RESult? :ALTErnate<1 2> :STATe :RESult? | <string> 1 to 8 < name> <string> -- -- -- -- -- ARFCn TXBand RXBand COMBined DCSRx1800 ARFCn TXBand RXBand COMBined DCSRx1800 ARFCn TXBand RXBand COMBined DCSRx1800 -- TXBand OTXBand RXBand IDLeband TXBand OTXBand RXBand IDLeband <numeric_value> <Boolean> <numeric_value>, <numeric_value> <Boolean> -- <numeric_value>, <numeric_value> <Boolean> -- | DB DB; DB DB; DB | Option FSE-K11 or FSE-K10 query only query only query only query only, option FSE-K20/K21 Option FSE-K11 or FSE-K10 query only query only query only query only; Option FSE-K11 or FSE-K10 query only query only; Option FSE-K11 or FSE-K10 query only query only |

:CALCulate<1|2>:LIMit<1 to 8>:ACTive?

This command queries the names of all activated limit lines. The names are output in alphabetical order. If no limit line is activated, an empty string will be output. The numeric suffixes in CALCulate<1|2> and LIMit<1 to 8> are not significant.

Example: ":CALC:LIM:ACT?"

Features: *RST value: -
 SCPI: device-specific

Mode: A, VA, BTS, MS

:CALCulate<1|2>:LIMit<1 to 8>:TRACe 1 to 4

This command assigns a trace to a limit line.

Example: ":CALC:LIM2:TRAC 2"

Features: *RST value: 1
 SCPI: device-specific

Modes: A, VA, BTS, MS

:CALCulate<1|2>:LIMit<1 to 8>:STATe ON | OFF

This command switches the limit check for the selected limit line on or off. With limit check switched off, the limit line is disabled.

Example: " :CALC:LIM:STAT ON"

Features: *RST value: OFF
SCPI: conforming

Modes: A, VA, BTS, MS

The result of the limit check can be queried with CALCulate:LIMit:FAIL?.

:CALCulate<1|2>:LIMit<1 to 8>:UNIT DBM | DBPW | DBPT | WATT | DBUV | DBMV | VOLT | DBUA | AMPere | DB | DBUV_MHZ | DBMV_MHZ | DBUA_MHZ | DBUV_M | DBUA_M | DBUV_MMHZ | DBUA_MMHZ | UNITLESS|

This command defines the unit of the selected limit line.

Example: " :CALC:LIM:UNIT DBUV"

Features: *RST value: DBM
SCPI: device-specific

Modes: A, VA, BTS, MS

DBUV_MHZ and DBUA_MHZ denote the units DBUV/MHZ or DBUA/MHZ.

Upon selection of the unit DB the limit line is automatically switched to the relative mode. For units different from DB the limit line is automatically switched to the absolute mode.

The units DEG, RAD, S, HZ are available in the vector analysis mode only.

:CALCulate<1|2>:LIMit:CATalog?

This command reads out the names of all limit lines stored on the harddisk.

Syntax of output format:

<Sum of file lengths of all subsequent files>,<free memory on hard disk>,
<1st file name>,,<1st file length>,<2nd file name>,,<2nd file length>,....,<nth file name>,
<nth file length>

Example: " :CALC:LIM:CAT?"

Feature: *RST value: -
SCPI: device-specific

Mode: A, VA, BTS, MS

:CALCulate<1|2>:LIMit<1 to 8>:CONTrol[:DATA] <numeric_value>,<numeric_value>..

This command defines the X-axis values (frequencies or times) of the upper or lower limit lines.

Example: " :CALC:LIM:CONT 1MHz , 30MHz , 300MHz , 1GHz"

Features: *RST value: - (LIMit:STATe is set to OFF)
SCPI: conforming

Modes: A, VA, BTS, MS

The number of values for the CONTrol axis and the corresponding UPPer- and/or LOWER limit lines have to be identical. Available units are HZ | S | SYM, SYM only for vector signal analyzer mode.

:CALCulate<1|2>:LIMit<1 to 8>:CONTrol:DOMain FREQUency | TIME

This command defines the X-axis in the frequency or time domain.

Example: " :CALC:LIM:CONT:DOM TIME "

Features: *RST value: FREQUency
SCPI: device-specific

Modes: A, VA, BTS, MS

:CALCulate<1|2>:LIMit<1 to 8>:CONTrol:OFFSet <numeric_value>

This command defines an offset for the X-axis value of the selected relative limit line in the frequency or time domain.

Example: " :CALC:LIM:CONT:OFFS 100us "

Features: *RST value: 0
SCPI: device-specific

Modes: A, VA

:CALCulate<1|2>:LIMit<1 to 8>:CONTrol:MODE RELative | ABSolute

This command selects the relative or absolute scaling for the X-axis of the selected limit line.

Example: " :CALC:LIM:CONT:MODE REL "

Features: *RST value: ABSolute
SCPI: device-specific

Modes: A, VA, BTS, MS

Upon selection of RELative, the unit is switched to DB.

:CALCulate<1|2>:LIMit<1 to 8>:CONTrol:UNIT[:TIME] S | SYM

This command defines the unit of the x-axis scaling of limit lines.

Example: " :CALC:LIM:CONT:UNIT SYM "

Features: *RST value: S
SCPI: device-specific

Mode: VA

:CALCulate<1|2>:LIMit<1 to 8>:CONTrol:SHIFt <numeric_value>

This command shifts a limit line which has been specified for relative frequencies or times (X-axis).

Example: " :CALC:LIM:CONT:SHIF 50kHz "

Features: *RST value: --
SCPI: device-specific

Modes: A, VA, BTS, MS

This command is an event which is why it is not assigned an *RST value and has no query.

:CALCulate<1|2>:LIMit<1 to 8>:CONTrol:SPACing LINear | LOGarithmic

This command makes a selection between linear and logarithmic interpolation for determining the limit line from the frequency points.

Example: " :CALC:LIM:CONT:SPAC LIN "

Features: *RST value: LIN
SCPI: device-specific

Modes: A, VA, BTS, MS

:CALCulate<1|2>:LIMit<1 to 8>:UPPer[:DATA] <numeric_value>,<numeric_value>..

This command defines the values for the upper limit lines.

Example: " :CALC:LIM:UPP -10,0,0,-10 "

Features: *RST value: - (LIMit:STATe is set to OFF)
SCPI: conforming

Modes: A, VA, BTS, MS

The number of values for the CONTrol axis and the corresponding UPPer limit line have to be identical. The unit must be identical with the unit selected by command CALC:LIM:UNIT.

If the measured values exceed the UPPer limit line, the limit check signals errors.

The unit must be identical with the unit selected by CALC:LIM:UNIT.

The units DEG, RAD, S, and HZ are available in the vector signal analysis mode only.

:CALCulate<1|2>:LIMit<1 to 8>:UPPer:STATe ON | OFF

This command defines the selected limit line as upper limit line.

Example: " :CALC:LIM:UPPer:STAT ON "

Features: *RST value: OFF
SCPI: conforming

Modes: A, VA, BTS, MS

The limit check is switched on with command CALCulate:LIMit:STATe ON. The result of the limit check can be queried with CALCulate:LIMit<1 to 8>:FAIL?.

:CALCulate<1|2>:LIMit<1 to 8>:UPPer:OFFSet <numeric_value>

This command defines an offset for the Y-axis of the selected relative upper limit line.

Example: " :CALC:LIM:UPP:OFFS 3dB "

Features: *RST value: 0
SCPI: device-specific

Modes: A, VA

:CALCulate<1|2>:LIMit<1 to 8>:UPPer:MARGin <numeric_value>

This command defines the margin of the selected upper limit line.

Example: " :CALC:LIM:UPP:MARG 10dB "

Features: *RST value: 0
SCPI: device-specific

Modes: A, VA, BTS, MS

:CALCulate<1|2>:LIMit<1 to 8>:UPPer:MODE RELative | ABSolute

This command selects the relative or absolute scaling for the Y-axis of the selected upper limit line.

Example: " :CALC:LIM:UPP:MODE REL "

Features: *RST value: ABSolute
SCPI: device-specific

Modes: A, VA, BTS, MS

:CALCulate<1|2>:LIMit<1 to 8>:UPPer:SHIFt <numeric_value>

This command shifts a limit line, which has relative values for the Y-axis (levels or linear units such as volt).

Example: " :CALC:LIM:UPP:SHIF 20dB "

Features: *RST value: --
SCPI: device-specific

Modes: A, VA, BTS, MS

This command is an event which is why it is not assigned an *RST value and has no query.

:CALCulate<1|2>:LIMit<1 to 8>:UPPer:SPACing LINear | LOGarithmic

This command makes a selection between linear and logarithmic interpolation for the upper limit line.

Example: " :CALC:LIM:UPP:SPAC LIN "

Features: *RST value: LIN
SCPI: device-specific

Modes: A, VA, BTS, MS

:CALCulate<1|2>:LIMit<1 to 8>:LOWer[:DATA] <numeric_value>,<numeric_value>..

This command defines the values for the selected lower limit line.

Example: " :CALC:LIM:LOW -30,-40,-40,-30 "

Features: *RST value: - (LIMit:STATe is set to OFF)
SCPI: conforming

Modes: A, VA, BTS, MS

The number of values for the CONTROL axis and the corresponding LOWER limit line have to be identical. If the measured values violate the LOWER limit line, the limit check signals errors. The unit must be identical with the unit selected by command CALC:LIM:UNIT.

The units DEG, RAD, S, and HZ are available in the vector signal analysis mode only.

:CALCulate<1|2>:LIMit<1 to 8>:LOWer:STATe ON | OFF

This command defines the selected limit line as lower limit line.

Example: ":CALC:LIM:LOWer:STAT ON"

Features: *RST value: OFF
 SCPI: conforming

Modes: A, VA, BTS, MS

The limit check is switched on with command `CALCulate:LIMit:STATe ON`. The result of the limit check can be queried with `CALCulate:LIMit:FAIL?`.

:CALCulate<1|2>:LIMit<1 to 8>:LOWer:OFFSet <numeric_value>

This command defines an offset for the Y-axis of the selected relative lower limit line.

Example: ":CALC:LIM:LOW:OFFS 3dB"

Features: *RST value: 0
 SCPI: device-specific

Modes: A, VA

:CALCulate<1|2>:LIMit<1 to 8>:LOWer:MARGin <numeric_value>

This command defines the margin of the selected lower limit line.

Example: ":CALC:LIM:LOW:MARG 10dB"

Features: *RST value: 0
 SCPI: device-specific

Modes: A, VA, BTS, MS

:CALCulate<1|2>:LIMit<1 to 8>:LOWer:MODE RELative | ABSolute

This command selects the relative or absolute scaling for the Y-axis of the selected lower limit line.

Example: ":CALC:LIM:LOW:MODE REL"

Features: *RST value: ABSolute
 SCPI: device-specific

Modes: A, VA, BTS, MS

:CALCulate<1|2>:LIMit<1 to 8>:LOWer:SHIFt <numeric_value>

This command shifts a limit line, which has relative values for the Y-axis (levels or linear units such as volt).

Example: ":CALC:LIM:LOW:SHIF 20dB"

Features: *RST value: --
 SCPI: device-specific

Modes: A, VA, BTS, MS

This command is an event which is why it is not assigned an *RST value and has no query.

:CALCulate<1|2>:LIMit<1 to 8>:LOWer:SPACing LINear | LOGarithmic

This command makes a selection between linear and logarithmic interpolation for the lower limit line.

Example: " :CALC:LIM:LOW:SPAC LIN"

Features: *RST value: LIN
SCPI: device-specific

Modes: A, VA, BTS, MS

:CALCulate<1|2>:LIMit<1 to 8>:FAIL?

This command queries the result of the limit check.

Example: " :CALC:LIM:FAIL?"

Features: *RST value: -
SCPI: conforming

Modes: A, VA, BTS, MS

The result of the limit check responds with 0 in case of PASS and with 1 in case of FAIL.

For measurements spectrum due to modulation and spectrum due to transients (options FSE-K10 and FSE-K11), the result of the limit check is queried with this command in frequency sweep mode.

:CALCulate<1|2>:LIMit<1 to 8>:CLEar[:IMMediate]

This command deletes the result of the current limit check.

Example: " :CALC:LIM:CLE "

Features: *RST value: -
SCPI: conforming

Modes: A, VA, BTS, MS

This command is an event which is why it is not assigned an *RST value.

:CALCulate<1|2>:LIMit<1 to 8>:COMMent <string>

This command defines a comment for the limit line selected.

Example: " :CALC:LIM:COMM 'Upper limit for spectrum' "

Features: *RST value: blank comment
SCPI: device-specific

Modes: A, VA, BTS, MS

:CALCulate<1|2>:LIMit<1 to 8>:COPY 1 to 8 | <name>

This command copies one limit line onto another one.

Parameter: 1 to 8 ::= number of the new limit line or, alternatively:
<name> ::= name of the new limit line given as a string

Example: " :CALC:LIM1:COPY 2 "
" :CALC:LIM1:COPY 'GSM2' "

Features: *RST value: --
SCPI: device-specific

Modes: A, VA, BTS, MS

The name of the limit line may contain a maximum of 8 characters. This command is an "event" which is why it is not assigned an *RST value and has no query.

:CALCulate<1|2>:LIMit<1 to 8>:NAME <name of limit line>

This command assigns a name to a limit line numbered 1 to 8. If a limit line of the given name doesn't exist previously, a limit line with this name is created. The values of a previous limit line with the selected line number are kept and the current unit is used. If no limit line with the selected line number was defined yet, the correct values for the x and y axis have to be entered before the new limit line will be saved (using commands CALCulate:LIMit:CONTRol:DATA and CALCulate:LIMit:LOWer|UPPer:DATA).

Example: " :CALC:LIM1:NAME 'GSM1' "

Features: *RST value: 'REM1' to 'REM8' for lines 1 to 8
SCPI: device-specific

Modes: A, VA, BTS, MS

The name of the limit line may contain a maximum of 8 characters.

:CALCulate<1|2>:LIMit<1 to 8>:DELeTe

This command deletes the limit line selected.

Examples: " :CALC:LIM1:DEL "

Features: *RST value: --
SCPI: device-specific

Modes: A, VA, BTS, MS

This command is an "event" which is why it is not assigned an *RST value and has no query.

:CALCulate<1|2>:LIMit<1 to 8>:BURSt:PTEMplate?

This command queries the result of the limit check for a power vs. time measurement.

Parameter: The result is displayed in character data form. Possible values are:

| | | |
|---------|--------|---------------------------|
| | PASSED | limit not exceeded |
| FAILED | | limit exceeded |
| RUNNING | | measurement not completed |

Examples: " :CALC:LIM:BURS:PTEM? "

Features: *RST value: --
SCPI: device-specific

Modes: BTS, MS

This command is a query and therefore not assigned a *RST value.

If no measurement has been carried out yet, a query error is triggered off. The numeric suffixes <1|2> or <1 to 8> are not significant for this command.

:CALCulate<1|2>:LIMit<1 to 8>:BURSt:POWer?

This command queries the total result of the carrier power measurement.

Parameter: The result is displayed in character data form. Possible values are:

| | |
|---------|---------------------------|
| PASSED | limit not exceeded |
| FAILED | limit exceeded |
| ABORTED | measurement aborted |
| RUNNING | measurement not completed |

Examples: " :CALC:LIM:BURS:POW? "
Result: PASSED

Features: *RST value: --
SCPI: device-specific

Modes: BTS, MS

This command is a query and therefore not assigned a *RST value.

If the command is triggered off before the carrier power measurement was started for the first time, a query error results. The numeric suffixes <1|2> or <1 to 8> are not significant for this command.

:CALCulate<1|2>:LIMit<1 to 8>:BURSt:PFERror?

This command queries the total result of the phase/frequency measurement.

Parameter: Result 1 limit not exceeded
0 limit exceeded

Example: " :CALC:LIM:BURS:PFER? "
Result:1

Features: *RST value: --
SCPI: device-specific

Modes: BTS, MS

This command is a query and therefore not assigned a *RST value.

If the command is triggered off before the phase/frequency measurement was started for the first time, a query error results. The numeric suffixes <1|2> or <1 to 8> are not significant for this command.

:CALCulate<1|2>:LIMit<1 to 8>:BURSt:MACCuracy?

This command queries the total result of the modulation accuracy measurement.

Parameter: 1 limit not exceeded
 0 limit exceeded

Example: " :CALC:LIM:BURS:MACC? "
 Result: 1

Features: *RST value: --
 SCPI: device-specific

Modes: BTS, MS

This command is a query and therefore not assigned a *RST value.
 If the command is triggered off before the cphase-frequency measurement was started for the first time, a query error results. The numeric suffixes <1|2> or <1 to 8> are not significant for this command. This command is only available in conjunction with option FSE-K20 / FSE-K21 .

:CALCulate<1|2>:LIMit<1 to 8>:SPECtrum:MODulation? ARFCn | TXBand | RXBand | COMBined | DCSRx1800

This command queries the total result of the spectrum due to modulation measurement for list mode. For frequency mode, the limit violations are queried with command CALCulate:LIMit:FAIL? .

Parameter: The result is displayed in character data form. Possible values are:

PASSED limit not exceeded
 FAILED limit exceeded
 ABORTED measurement aborted
 RUNNING measurement not completed

Examples: " :CALC:LIM:SPEC:MOD? RXB "
 Result: PASSED

Features: *RST value: --
 SCPI: device-specific

Modes: BTS, MS

| | | | |
|-----------|--|----------|---------------------------|
| ARFCn | ARFCN ± 1.8 MHz | TXBand | TX-band |
| RXBand | RX-band | COMBined | ARFCN ± 1.8 MHz / TX-band |
| DCSRx1800 | RX-Band DCS 1800 (option FSE-K10 only) | | |

This command is a query and therefore not assigned a *RST value.
 The numeric suffixes <1|2> or <1 to 8> are not significant for this command.

:CALCulate<1|2>:LIMit<1 to 8>:SPECtrum:MODulation:FAILs? ARFCn | TXBand | RXBand | COMBined | DCSRx1800

This command queries the number of limit violations of the spectrum due to modulation measurement for list mode. The number of limit violations is the total of all violations above and below the carrier. For frequency mode, the limit violations are queried with command `CALCulate:LIMit:FAIL?`.

Examples: " :CALC:LIM:SPEC:MOD:FAIL? RXB "

Features: *RST value: --
SCPI: device-specific

Modes: BTS, MS

| | |
|-----------|--|
| ARFCn | ARFCN \pm 1.8 MHz |
| TXBand | TX-band |
| RXBand | RX-band |
| COMBined | ARFCN \pm 1.8 MHz / TX-band |
| DCSRx1800 | RX-Band DCS 1800 (option FSE-K10 only) |

This command is a query and therefore not assigned a *RST value. The numeric suffixes <1|2> or <1 to 8> are not significant for this command.

:CALCulate<1|2>:LIMit<1 to 8>:SPECtrum:MODulation:EXCptions? ARFCn | TXBand | RXBand | COMBined | DCSRx1800

This command queries the number of limit violations of the spectrum due to modulation measurement which are marked as exceptions. This command is only available for list mode.

Examples: " :CALC:LIM:SPEC:MOD:EXC? RXB "

Features: *RST value: --
SCPI: device-specific

Modes: BTS, MS

| | |
|-----------|--|
| ARFCn | ARFCN \pm 1.8 MHz |
| TXBand | TX-band |
| RXBand | RX-band |
| COMBined | ARFCN \pm 1.8 MHz / TX-band |
| DCSRx1800 | RX-Band DCS 1800 (option FSE-K10 only) |

This command is a query and therefore not assigned a *RST value. The numeric suffixes <1|2> or <1 to 8> are not significant for this command.

:CALCulate<1|2>:LIMit<1 to 8>:SPECtrum:SWITching?

This command queries the total result of the spectrum due to switching transients measurements for list mode. For frequency mode, the limit violations are queried with command `CALCulate:LIMit:FAIL?`

Parameter: The result is displayed in character data form. Possible values are:

| | |
|---------|---------------------------|
| PASSED | limit not exceeded |
| FAILED | limit exceeded |
| ABORTED | measurement aborted |
| RUNNING | measurement not completed |

Examples: `" :CALC:LIM:SPEC:SWIT?"`
 Result: PASSED

Features: *RST value: --
 SCPI: device-specific

Modes: BTS, MS

This command is a query and therefore not assigned a *RST value. The numeric suffixes <1|2> or <1 to 8> are not significant for this command.

:CALCulate<1|2>:LIMit<1 to 8>:SPECtrum:SWITching:FAILs?

This command queries the number of limit violations of the spectrum due to switching transient measurement for list mode. The number of limit violations is the total of all violations above and below the carrier. For frequency mode, the limit violations are queried with command `CALCulate:LIMit:FAIL?`.

Examples: `" :CALC:LIM:SPEC:SWIT:FAIL?"`

Features: *RST value: --
 SCPI: device-specific

Modes: BTS, MS

This command is a query and therefore not assigned a *RST value. The numeric suffixes <1|2> or <1 to 8> are not significant for this command.

:CALCulate<1|2>:LIMit<1 to 8>:SPURious? TXBand | OTXBand | RXBand | IDLeband

This command queries the total result of the spurious emissions measurement.

Parameter: The result is displayed in character data form. Possible values are:

| | |
|---------|---------------------------|
| PASSED | limit not exceeded |
| FAILED | limit exceeded |
| ABORTED | measurement aborted |
| RUNNING | measurement not completed |

Examples: `" :CALC:LIM:SPUR? OTXB"`
 Result: PASSED

Features: *RST value: --
 SCPI: device-specific

Modes: BTS, MS

| | |
|----------|--------------------------------|
| TXBand | TX-band |
| OTXBand | Not TX-band |
| RXBand | RX-band (option FSE-K11 only) |
| IDLeband | IDLeband (option FSE-K10 only) |

This command is a query and therefore not assigned a *RST value. The numeric suffixes <1|2> or <1 to 8> are not significant for this command.

:CALCulate<1|2>:LIMit<1 to 8>:SPURious:FAILs? TXBand | OTXBand | RXBand | IDLeband

This command queries the number of limit violations of the spurious emissions measurement.

Examples: " :CALC:LIM:SPUR:FAIL? OTXB "

Features: *RST value: --
SCPI: device-specific

Modes: BTS, MS

TXBand TX-band
OTXBand Not TX-band
RXBand RX-band (option FSE-K11 only)
IDLeband IDLeband (option FSE-K10 only)

This command is a query and therefore not assigned a *RST value. The numeric suffixes <1|2> or <1 to 8> are not significant for this command.

:CALCulate<1|2>:LIMit<1 to 8>:MARGin 0 to 100DB

This command sets/changes the value of the margin (safe difference to the actual limit) for the limit check.

Examples: " :CALC:LIM:MARG 6DB "

Features: *RST value: 3DB
SCPI: device-specific

Modes: BTS, MS

The numeric suffixes <1|2> or <1 to 8> are not significant for this command.

:CALCulate<1|2>:LIMit<1 to 8>:ACPpower[:STATe] ON | OFF

This command switches on and off the limit check for adjacent channel power measurements. The commands `CALC:LIM:ACP:ACH:STAT` or `CALC:LIM:ACP:ALT:STAT` must be used in addition to specify whether the limit check is to be performed for the upper/lower adjacent channel or for the alternate adjacent channels.

Examples: " :CALC:LIM:ACP ON "

Features: *RST value: OFF
SCPI: device-specific

Modes: A, VA

The numeric suffixes <1|2> or <1 to 8> are not significant for this command.

:CALCulate<1|2>:LIMit<1 to 8>:ACPpower:ACHannel 0 to 100 dB, 0 to 100 dB

This command defines the limit for the upper/lower adjacent channel for adjacent channel power measurements.

Parameter: The first (second) numeric value is the limit for the upper (lower) adjacent channel.

Examples: " :CALC:LIM:ACP:ACH 30DB, 30DB "

Features: *RST value: 0 dB
SCPI: device-specific

Modes: A, VA

The numeric suffixes <1|2> or <1 to 8> are not significant for this command.

:CALCulate<1|2>:LIMit<1 to 8>:ACPower:ACHannel:STATe ON | OFF

This command activates the limit check for the adjacent channel when adjacent channel power measurement is performed. Before, the limit check must be activated using `CALC:LIM:ACP ON`.

Examples: " :CALC:LIM:ACP:ACH:STAT ON "

Features: *RST value: OFF
SCPI: device-specific

Modes: A, VA

The numeric suffixes <1|2> or <1 to 8> are not significant for this command.

:CALCulate<1|2>:LIMit<1 to 8>:ACPower:ACHannel:RESult?

This command queries the result of the limit check for the upper/lower adjacent channel when adjacent channel power measurement is performed.

Parameter: The result is returned in the form <result>, <result> where <result> = PASSED | FAILED, and where the first returned value denotes the lower, the second denotes the upper adjacent channel.

Examples: " :CALC:LIM:ACP:ACH:RES? "

Features: *RST value: --
SCPI: device-specific

Modes: A, VA

This command is a query and therefore not assigned a *RST value. If the power measurement of the adjacent channel is switched off, the command triggers a query error.

The numeric suffixes <1|2> or <1 to 8> are not significant for this command.

:CALCulate<1|2>:LIMit<1 to 8>:ACPower:ALternate<1|2> 0 to 100DB, 0 to 100 dB.

This command defines the limit for the first/second alternate adjacent channel for adjacent channel power measurements.

Parameter: The first (second) numeric value is the limit for the lower (upper) alternate adjacent channel. The numeric suffix after `ALternate<1|2>` denotes the first or the second alternate channel.

Examples: " :CALC:LIM:ACP:ALT2 30DB 30DB "

Features: *RST value: 0DB
SCPI: device-specific

Modes: A, VA

The numeric suffixes <1|2> or <1 to 8> are not significant for this command.

:CALCulate<1|2>:LIMit<1 to 8>:ACPpower:ALternate<1|2>:STATe ON | OFF

This command activates the limit check for the first/second alternate adjacent channel for adjacent channel power measurements. Before, the limit check must be activated using `CALC:LIM:ACP ON`.

Examples: "`:CALC:LIM:ACP:ALT2:STAT ON`"

Features: *RST value: OFF
 SCPI: device-specific

Modes: A, VA

The numeric suffixes `<1|2>` or `<1 to 8>` are not significant for this command.

:CALCulate<1|2>:LIMit<1 to 8>:ACPpower:ALternate<1|2>:RESult?

This command queries the result of the limit check for the first/second alternate adjacent channel for adjacent channel power measurements.

Parameter: The result is returned in the form `<result>`, `<result>` where `<result>` = PASSED | FAILED and where the first (second) returned value denotes the lower (upper) alternate adjacent channel.

Examples: "`:CALC:LIM:ACP:ALT2:RES?`"

Features: *RST value: --
 SCPI: device-specific

Modes: A, VA

This command is a query and therefore not assigned a *RST value. If the power measurement of the adjacent channel is switched off, the command triggers a query error.

The numeric suffixes `<1|2>` or `<1 to 8>` are not significant for this command.

CALCulate:MARKer Subsystem

The CALCulate:MARKer subsystem checks the marker functions in the instrument.

| COMMAND | PARAMETERS | UNIT | COMMENT |
|-----------------|---------------------|--------------|-------------------------------------|
| CALCulate<1 2> | | | |
| :MARKer<1 to 4> | | | |
| [:STATe] | <Boolean> | -- | |
| :AOFF | | | no query |
| :TRACe | <numeric_value> | -- | |
| :X | <numeric_value> | HZ S SYM | |
| :SLIMits | | | |
| [:STATe] | <Boolean> | | |
| :COUNt | <Boolean> | -- | |
| :RESolution | <numeric_value> | HZ | |
| :FREQuency? | -- | -- | query only |
| :COUPled | | | |
| [:STATe] | <Boolean> | | |
| :LOEXclude | <Boolean> | | |
| :Y? | -- | -- | query only |
| :MAXimum | | | |
| [:PEAK] | -- | -- | no query |
| :APEak | -- | -- | no query, Vector Signal Analysis |
| :NEXT | -- | -- | no query |
| :RIGHT | -- | -- | no query |
| :LEFT | -- | -- | no query |
| :MINimum | | | |
| [:PEAK] | -- | -- | no query |
| :NEXT | -- | -- | no query |
| :RIGHT | -- | -- | no query |
| :LEFT | -- | -- | no query |
| :STEP | | | |
| [:INCRement] | <numeric_value> | HZ S SYM | |
| :AUTO | <Boolean> | -- | |
| :PEXCursion | <numeric_value> | DB | |
| :READout | MPHase RIMaginary | | Vector Signal Analysis |
| :FUNCTion | | | |
| :NDBDown | <numeric_value> | DB | |
| :STATe | <Boolean> | | |
| :RESult? | -- | -- | query only |
| :FREQuency? | -- | -- | query only |
| :ZOOM | <numeric_value> | HZ | no query |
| :NOISe | | | |
| [:STATe] | <Boolean> | | |
| :RESult? | -- | -- | query only |
| :DEModulation | | | |
| :SElect | AM FM | | |
| [:STATe] | <Boolean> | | |
| :HOLDoff | <numeric_value> | S | |
| :SFACtor | <expr> | | |
| :STATe | <Boolean> | | |
| :RESult? | -- | -- | query only |
| :FREQuency? | -- | -- | query only |

:CALCulate<1|2>:MARKer<1 to 4>[:STATe] ON | OFF

This command switches on or off the currently selected marker. If no indication is made, marker 1 is selected automatically.

Example: " :CALC:MARK3 ON "

Features: *RST value: OFF
SCPI: device-specific

Modes: A, VA, BTS, MS

:CALCulate<1|2>:MARKer<1 to 4>:AOFF

This command switches off all active markers.

Example: " :CALC:MARK:AOFF "

Features: *RST value: -
SCPI: device-specific

Modes: A, VA, BTS, MS

This command is an event which is why it is not assigned an *RST value and has no query.

:CALCulate<1|2>:MARKer<1 to 4>:TRACe 1 to 4

This command assigns the selected marker (1 to 4) to the indicated test curve.

Example: " :CALC:MARK3:TRAC 2 "

Features: *RST value -
SCPI: device-specific

Modes: A, VA, BTS, MS

:CALCulate<1|2>:MARKer<1 to 4>:X 0 to MAX (frequency | sweep time | symbols)

This command positions the selected marker to the indicated frequency (span > 0) or time (span = 0).

Example: " :CALC:MARK:X 10.7MHz "

Features: *RST value: -
SCPI: device-specific

Modes: A, VA, BTS, MS

The unit SYM is available only in the vector signal analysis mode.

:CALCulate<1|2>:MARKer<1 to 4>:X:SLIMits[:STATe] ON | OFF

This command switches between a limited (ON) and unlimited (OFF) search range.

Example: " :CALC:MARK:X:SLIM ON "

features: *RST value: OFF
SCPI: device-specific

Modes: A, VA

:CALCulate<1|2>:MARKer<1 to 4>:COUNT ON | OFF

This command switches on or off the frequency counter at the marker position.

Example: " :CALC:MARK:COUN ON"
Features: *RST value: OFF
 SCPI: device-specific
Mode: A

:CALCulate<1|2>:MARKer<1 to 4>:COUNT:RESolution 0.1 | 1 | 10 | 100 | 1000 | 10000 Hz

This command specifies the resolution of the frequency counter.

Example: " :CALC:MARK:COUN:RES 1kHz "
Features: *RST value: 1kHz
 SCPI: device-specific
Mode: A

The numeric suffix in MARKer<1 to 4> is not significant.

:CALCulate<1|2>:MARKer<1 to 4>:COUNT:FREQuency?

This command queries the result of the frequency counter.

Example: " :CALC:MARK:COUN:FREQ? "
Features: *RST value: -
 SCPI: device-specific
Modes: A, BTS, MS

This command is only a query and thus has no *RST value.

:CALCulate<1|2>:MARKer<1 to 4>:COUPled[:STATe] ON | OFF

This command switches the coupling of markers on or off.

Example: " :CALC:MARK:COUP ON"
Features: *RST value: OFF
 SCPI: device-specific
Modes: VA

The numeric suffix in MARKer<1 to 4> is not significant.

:CALCulate<1|2>:MARKer<1 to 4>:LOEXclude ON | OFF

This command switches the local oscillator suppression on or off.

Example: " :CALC:MARK:LOEX ON"
Features: *RST value: OFF
 SCPI: device-specific
Mode: A-F

The numeric suffixes 1|2 and 1 to 4 are not significant.

:CALCulate<1|2>:MARKer<1 to 4>:Y?

This command queries the selected marker value.

Example: " : CALC : MARK : Y ? "

Features: *RST value: -
SCPI: device-specific

Modes: A, VA, BTS, MS

:CALCulate<1|2>:MARKer<1 to 4>:MAXimum[:PEAK]

This command positions the marker to the current maximum value in the trace memory.

Example: " : CALC : MARK : MAX "

Features: *RST value: -
SCPI: device-specific

Modes: A, VA, BTS, MS

This command is an event which is why it is not assigned an *RST value and has no query.

:CALCulate<1|2>:MARKer<1 to 4>:MAXimum:APEak

This command positions the marker to the maximum absolute value of the trace.

Example: " : CALC : MARK : MAX : APE "

Features: *RST value: -
SCPI: device-specific

Mode: VA

This command is an event which is why it is not assigned an *RST value and has no query.

:CALCulate<1|2>:MARKer<1 to 4>:MAXimum:NEXT

This command positions the marker to the next lower maximum value in the trace memory.

Example: " : CALC : MARK : MAX : NEXT "

Features: *RST value: -
SCPI: device-specific

Modes: A, BTS, MS

This command is an event which is why it is not assigned an *RST value and has no query.

:CALCulate<1|2>:MARKer<1 to 4>:MAXimum:RIGHT

This command positions the marker to the next smaller maximum value to the right of the current value (i.e., in ascending X direction) in the trace memory.

Example: " : CALC : MARK : MAX : RIGH "

Features: *RST value: -
SCPI: device-specific

Modes: A, BTS, MS

This command is an event which is why it is not assigned an *RST value and has no query.

:CALCulate<1|2>:MARKer<1 to 4>:MAXimum:LEFT

This command positions the marker to the next smaller maximum value to the left of the current value (i.e., in descending X direction) in the trace memory.

Example: " : CALC : MARK : MAX : LEFT "

Features: *RST value: -
SCPI: device-specific

Modes: A, BTS, MS

This command is an event which is why it is not assigned an *RST value and has no query.

:CALCulate<1|2>:MARKer<1 to 4>:MINimum[:PEAK]

This command positions the marker to the current minimum value in the trace memory.

Example: " : CALC : MARK : MIN "

Features: *RST value: -
SCPI: device-specific

Modes: A, VA, BTS, MS

This command is an event which is why it is not assigned an *RST value and has no query.

:CALCulate<1|2>:MARKer<1 to 4>:MINimum:NEXT

This command positions the marker to the next higher minimum value in the trace memory.

Example: " : CALC : MARK : MIN : NEXT "

Features: *RST value: -
SCPI: device-specific

Modes: A, BTS, MS

This command is an event which is why it is not assigned an *RST value and has no query.

:CALCulate<1|2>:MARKer<1 to 4>:MINimum:RIGHT

This command positions the marker to the next higher minimum value to the right of the current value (ie in ascending X direction).

Example: " : CALC : MARK : MIN : RIGH "

Features: *RST value: -
SCPI: device-specific

Modes: A, BTS, MS

This command is an event which is why it is not assigned an *RST value and has no query.

:CALCulate<1|2>:MARKer<1 to 4>:MINimum:LEFT

This command positions the marker to the next higher minimum value to the left of the current value (ie in descending X direction).

Example: " : CALC : MARK : MIN : LEFT "

Features: *RST value: -
SCPI: device-specific

Modes: A, BTS, MS

is command is an event which is why it is not assigned an *RST value and has no query.

:CALCulate<1|2>:MARKer<1 to 4>:STEP[:INCRement] <numeric_value>

This command defines the marker step width.

Example: " :CALC:MARK:STEP 10kHz " (frequency domain)
CALC:MARK:STEP 5ms " (time domain)

Features: *RST value: - (STEP is set to AUTO)
SCPI: device-specific

Mode: A

This command sets STEP:AUTO to OFF. The numeric suffix in MARKer<1 to 4> is not significant.

:CALCulate<1|2>:MARKer<1 to 4>:STEP:AUTO ON | OFF

This command switches the automatic adaptation of the marker step width on or off.

Example: " :CALC:MARK:STEP:AUTO OFF "

Features: *RST value: ON
SCPI: device-specific

Mode: A

With AUTO ON, the step width is 10% of the span. The numeric suffix in MARKer<1 to 4> is not significant.

:CALCulate<1|2>:MARKer<1 to 4>:PEXCursion <numeric_value>

This command defines the peak excursion.

Example: " :CALC:MARK:PEXC 10dB "

Features: *RST value: 6dB
SCPI: device-specific

Modes: A, VA, BTS, MS

The numeric suffix in MARKer<1 to 4> is not significant.

:CALCulate<1|2>:MARKer<1 to 4>:READout MPHase | RIMaginary

This command determines the type of the marker display.

Example: " :CALC:MARK:READ RIM "

Features: *RST value: -
SCPI: device-specific

Mode: VA-D

The numeric suffix in MARKer<1 to 4> is not significant.

:CALCulate<1|2>:MARKer<1 to 4>:FUNCtion:NDBDown <numeric_value>

This command defines the "N dB Down" value.

Example: " :CALC:MARK:FUNC:NDBD 3dB "

Features: *RST value: 6dB
SCPI: device-specific

Mode: A

The temporary markers T1 and T2 are positioned by n dB below the active reference marker. The frequency spacing of these markers can be queried with CALCulate:MARKer:FUNCtion:NDBDown:RESult?.

:CALCulate<1|2>:MARKer<1 to 4>:FUNCtion:NDBDown:STATe ON | OFF

This command switches the "N dB Down" function on or off.

Example: " :CALC:MARK:FUNC:NDBD:STAT ON "

Features: *RST value: OFF
SCPI: device-specific

Modes: A, BTS, MS

:CALCulate<1|2>:MARKer<1 to 4>:FUNCtion:NDBDown:RESult?

This command queries the frequency spacing (bandwidth) of the "N dB Down" markers.

Example: " :CALC:MARK:FUNC:NDBD:RES? "

Features: *RST value: -
SCPI: device-specific

Modes: A, BTS, MS

This command is only a query which is why it is not assigned an *RST value.

:CALCulate<1|2>:MARKer<1 to 4>:FUNCtion:NDBDown:FREQuency?

This command queries the frequencies of the "N dB Down" marker.

Example: " :CALC:MARK:FUNC:NDBD:FREQ? "

Features: *RST value: -
SCPI: device-specific

Modes: A, BTS, MS

The two frequency values are separated by comma and indicated in ascending order. This command is only a query which is why it is not assigned an *RST value.

:CALCulate<1|2>:MARKer<1 to 4>:FUNCTION:ZOOM <numeric_value>

This command defines the range to be enlarged around the active marker.

Example: " :CALC:MARK:FUNC:ZOOM 1kHz "

Features: *RST value: -
SCPI: device-specific

Mode: A-F

The subsequent frequency sweep is stopped at the marker position and the frequency of the signal is counted. This frequency becomes the new center frequency, the zoomed span is then set. This command is an event which is why it is not assigned an *RST value and has no query.

:CALCulate<1|2>:MARKer<1 to 4>:FUNCTION:NOISe[:STATE] ON | OFF

This command switches the noise measurement on or off.

Example: " :CALC:MARK:FUNC:NOIS ON "

Features: *RST value: OFF
SCPI: device-specific

Mode: A

The noise power density is measured at the position of the markers. The result can be queried with CALCulate:MARKer:FUNCTION:NOISe:RESult?.

:CALCulate<1|2>:MARKer<1 to 4>:FUNCTION:NOISe:RESult?

This command queries the result of the noise measurement.

Example: " :CALC:MARK:FUNC:NOIS:RES? "

Features: *RST value: -
SCPI: device-specific

Modes: A, BTS, MS

This command is an event which is why it is not assigned an *RST value and has no query.

:CALCulate<1|2>:MARKer<1 to 4>:FUNCTION:DEModulation:SElect AM | FM

This command selects the demodulation type.

Example: " :CALC:MARK:FUNC:DEM:SEL FM "

Features: *RST value: AM
SCPI: device-specific

Mode: A

:CALCulate<1|2>:MARKer<1 to 4>:FUNCtion:DEModulation[:STATe] ON | OFF

This command switches the demodulation on or off.

Example: " :CALC:MARK:FUNC:DEM ON "

Features: *RST value: OFF
SCPI: device-specific

Mode: A

With demodulation switched on, the frequency sweep is stopped at the marker position and the signal is demodulated during the given stop time.

:CALCulate<1|2>:MARKer<1 to 4>:FUNCtion:DEModulation:HOLDoff 10ms to 1000s

This command defines the duration of the stop time for the demodulation.

Example: " :CALC:MARK:FUNC:DEM:HOLD 3s "

Features: *RST value: - (DEModulation is set to OFF)
SCPI: device-specific

Mode: A

With demodulation switched on, the frequency sweep is stopped at the marker position and the signal is demodulated during the given stop time.

:CALCulate<1|2>:MARKer<1 to 4>:FUNCtion:SFACtor (60dB/3dB) | (60dB/6dB)

This command defines the shape factor measurement 60dB/6dB or 60dB/3dB.

Example: " :CALC:MARK:FUNC:SFAC (60dB/3dB) "

Features: *RST value: (60dB/6dB)
SCPI: device-specific

Modes: A, BTS, MS

The temporary markers T1 to T4 are positioned in pairs by 60dB and by 3dB or 6dB below the active reference marker. The frequency spacing ratio of these markers - the shape factor - can be queried with `CALCulate:MARKer:FUNCtion:SFACtor:RESult?`.

:CALCulate<1|2>:MARKer<1 to 4>:FUNCtion:SFACtor:STATe ON | OFF

This command switches the shape factor measurement on or off.

Example: " :CALC:MARK:FUNC:SFAC:STAT ON "

Features: *RST value: OFF
SCPI: device-specific

Modes: A, BTS, MS

:CALCulate<1|2>:MARKer<1 to 4>:FUNCtion:SFACtor:RESult?

This command queries the result of the shape factor measurement.

Example: " :CALC:MARK:FUNC:SFAC:RES? "

Features: *RST value: -
SCPI: device-specific

Modes: A, BTS, MS

This command is only a query which is why it is not assigned an *RST value.

:CALCulate<1|2>:MARKer<1 to 4>:FUNCtion:SFACtor:FREQUency?

This command queries the frequencies of the shape factor measurement.

Example: " :CALC:MARK:FUNC:SFAC:FREQ? "

Features: *RST value: -
SCPI: device-specific

Modes: A, BTS, MS

Four frequency values (at -60 dB, -6 or -3 dB, -6 or -3 dB, -60dB) are indicated in ascending order. They are separated by a comma. This command is only a query which is why it is not assigned an *RST value.

:CALCulate<1|2>:MARKer<1 to 4>:FUNCtion:STRack[:STATe] ON | OFF

This command switches the signal-track function on or off.

Example: " :CALC:MARK:FUNC:STR ON "

Features: *RST value: OFF
SCPI: device-specific

Mode: A-F

With SIGNAL TRACK function activated, the maximum signal is determined after each frequency sweep and the center frequency of this signal is set. With drifting signals the center frequency follows the signal.

:CALCulate<1|2>:MARKer<1 to 4>:FUNCtion:ADEMod:AM[:RESult]? PPEak| MPEak| MIDDLE| RMS

This command queries the results of the AM modulation measurement of the analog demodulation.

Example: " :CALC:MARK:FUNC:ADEM:AM? PPE "

Features: *RST value: -
SCPI: device-specific

Mode: VA-A

PPEak Result of the measurement with detector +PK
MPEak Result of the measurement with detector -PK
MIDDLE Result of averaging \pm PK/2
RMS Result of the measurement with detector RMS

In the modulation modes FM or PM query of the MIDDLE-result is possible only. This command is only a query which is why it is not assigned an *RST value.

:CALCulate<1|2>:MARKer<1 to 4>:FUNCtion:ADEMod:FM[:RESult]? PPEak | MPEak | MIDDLE | RMS | RDEV

This command queries the results of the FM modulation measurement of the analog demodulation.

Example: " :CALC:MARK:FUNC:ADEM:FM? PPE "

Features: *RST value: -
SCPI: device-specific

Mode: VA-A

PPEak Result of the measurement with detector +PK
MPEak Result of the measurement with detector -PK
MIDDLE Result of averaging $\pm PK/2$
RMS Result of the measurement with detector RMS

In the modulation modes FM or PM query of the MIDDLE-result is possible only. This command is only a query which is why it is not assigned an *RST value.

:CALCulate<1|2>:MARKer<1 to 4>:FUNCtion:ADEMod:PM[:RESult]?PPEak| MPEak| MIDDLE| RMS

This command queries the results of the PM modulation measurement of the analog demodulation.

Example: " :CALC:MARK:FUNC:ADEM:PM? PPE "

Features: *RST value: -
SCPI: device-specific

Mode: VA-A

PPEak Result of the measurement with detector +PK
MPEak Result of the measurement with detector -PK
MIDDLE Result of averaging $\pm PK/2$
RMS Result of the measurement with detector RMS

In the modulation modes FM or PM query of the MIDDLE-result is possible only. This command is only a query which is why it is not assigned an *RST value.

:CALCulate<1|2>:MARKer<1 to 4>:FUNCtion:ADEMod:AFRequency[:RESult]?

This command queries the audio frequency of the analog demodulation.

Example: " :CALC:MARK:FUNC:ADEM:AFR? "

Features: *RST value: -
SCPI: device-specific

Mode: VA-A

:CALCulate<1|2>:MARKer<1 to 4>:FUNCtion:ADEMod:FERRor[:RESult]?

This command queries the frequency error of the analog demodulation.

Example: " :CALC:MARK:FUNC:ADEM:FERR? "

Features: *RST value: -
SCPI: device-specific

Mode: VA-A

This command is only a query which is why it is not assigned an *RST value.

:CALCulate<1|2>:MARKer<1 to 4>:FUNCtion:ADEMod:CARRier[:RESult]?

This command queries the results of the carrier frequency measurement.

Example: " : CALC : MARK : FUNC : ADEM : CARR ? "

Features: *RST value: -
SCPI: device-specific

Mode: VA-A

This command is only a query which is why it is not assigned an *RST value.

:CALCulate<1|2>:MARKer<1 to 4>:FUNCtion:ADEMod:SINad[:STATe] ON | OFF

This command switches the SINAD measurement on or off.

Example: " : CALC : MARK : FUNC : ADEM : SIN ON "

Features: *RST value: OFF
SCPI: device-specific

Mode: VA-A

This command is valid only in the analog demodulation mode with Real Time ON.

:CALCulate<1|2>:MARKer<1 to 4>:FUNCtion:ADEMod:SINad:RESult?

This command queries the results of the SINAD measurement.

Example: " : CALC : MARK : FUNC : ADEM : SIN : RES ? "

Features: *RST value: -
SCPI: device-specific

Mode: VA-A

This command is only a query and thus has no *RST value assigned.

:CALCulate<1|2>:MARKer<1 to 4>:FUNCtion:DDEMod:RESult?

MERM | MEPK | MEPS | PERM | PEPK | PEPS | EVRM | EVPK | EVPS | IQOF | IQIM | ADR | FERR | FEPK | RHO | DEV | FSRM | FSPK | FSPS | DTTS

This command queries the error measurement results of digital demodulation. The results correspond to the values obtained when the symbol table (SYMBOL TABLE/ ERRORS softkey) is selected in manual operation. Marker values can be queried with command `CALCulate<1|2>:MARKer<1...4>:Y?` and trace data with command `TRACe[:DATA]`.

Example: `" :CALC:MARK:FUNC:DDEM:RES? EVRM "`

Features: *RST value: -
SCPI: device-specific

Mode: VA-D

| | | | |
|------|--|------|--|
| MERM | magnitude error in %rms | FERR | frequency error in Hz |
| MEPK | maximum of magnitude error in %pk | FEPK | maximum of frequency error in Hz |
| MEPS | symbol number by which the maximum of the magnitude error occurred | ADR | amplitude drop in dB/symbol |
| PERM | phase error in deg | RHO | Rho-Factor |
| PEPK | maximum of phase error in deg | DEV | FSK deviation in Hz |
| PEPS | symbol number by which the maximum of the phase error occurred | | |
| EVRM | vector error in %rms | FSPK | maximum of FSK deviation error in Hz |
| EVPK | maximum of vector error in %pk | FSRM | FSK deviation error in Hz |
| EVPS | symbol number by which the maximum of the vector error occurred | FSPS | symbol number by which the maximum of error occurred |
| IQOF | I/Q-offset error in % | DTTS | trigger delay of synchronization |
| IQIM | I/Q Imbalance in % | | |

This command is only a query which is why it is not assigned an *RST value.

:CALCulate<1|2>:MARKer<1 to 4>:FUNCtion:POWER:SElect ACPower | CPOWer | OBANdwidth | OBWidth | CN | CN0

This command selects the type of power measurement without modifying other settings.

Example: `" :CALC:MARK:FUNC:POW:SEL ACP "`

Features: *RST value: -
SCPI: device-specific

Mode: A-F

This command is an event which is why it is not assigned an *RST value.

| | |
|----------------------|---|
| ACPpower | adjacent channel power measurement |
| CPOWer | channel power measurement |
| OBANdwidth OBWidth | occupied bandwidth power measurement |
| CN | signal / noise power measurement |
| CN0 | signal-/ noise power measurement based on 1Hz bandwidth |

:CALCulate<1|2>:MARKer<1 to 4>:FUNction:POWER:RESult?ACPower | CPower | OBANdwidth | OBWidth | CN | CN0

This command queries the results of the power measurement (see also CALCulate:MARKer:FUNction:POWER:SElect.)

Example: " :CALC:MARK:FUNC:POW:RES? OBW "

Features: *RST value: -
SCPI: device-specific

Modes: A, VA, BTS, MS

ACPower adjacent channel power measurement; Results are output separated by commas in the following order: Power of main channel
Power of lower adjacent channel 1
Power of upper adjacent channel 1
Power of lower adjacent channel 2
Power of upper adjacent channel 2

...

The number of results depends on the number of adjacent channels selected. With logarithmic scaling (RANGE LOG), the power is output in dBm, with linear scaling (RANGE LIN dB or LIN %) in W. If SENSE:POWER:ACHannel:MODE REL is selected, adjacent channel power is output in dB.

CPower channel power measurement
With logarithmic scaling (RANGE LOG), the channel power is output in dBm, with linear scaling (RANGE LIN dB or LIN %) in W.

OBANdwidth | OBWidth occupied bandwidth power measurement
The return value is the occupied bandwidth in Hz

CN signal / noise power measurement
The return value is always in dB..

CN0 signal-/ noise power measurement based on 1Hz bandwidth
The return value is always in dB/Hz

This command is only a query which is why it is not assigned an *RST value.

:CALCulate<1|2>:MARKer<1 to 4>:FUNction:POWER[:STATe] OFF

This command switches the power measurement off.

Example: " :CALC:MARK:FUNC:POW OFF "

Features: *RST value: -
SCPI: device-specific

Modes: A-F, VA-D

This command is an event which is why it is not assigned an *RST value.

:CALCulate<1|2>:MARKer<1 to 4>:FUNCtion:POWer:PRESet

NADC | TETRA | PDC | PHS | CDPD | FWCDma | RWCDma | FW3Gppcdma |
 RW3Gppcdma | M2CDma | D2CDma | F8CDma | R8CDma | F19Cdma | R19Cdma |
 NONE | FO8Cdma | RO8Cdma | FO19CDMA | RO19CDMA | TCDMa

This command selects the settings for power measurement of one of the standards.

Example: " :CALC:MARK:FUNC:POW:PRES NADC "

Features: *RST value: -
 SCPI: device-specific

Mode: A-F

| | |
|------------|--------------------------|
| FWCDma | W-CDMA forward |
| RWCDma | W-CDMA reverse |
| FW3Gppcdma | W-CDMA 3GPP forward |
| RW3Gppcdma | W-CDMA 3GPP reverse |
| M2CDma | CDMA2000 Multi Carrier |
| D2CDma | CDMA2000 Direct Sequence |
| F8CDma | CDMA800 forward |
| R8CDma | CDMA800 reverse |
| F19Cdma | CDMA1900 forward |
| R19Cdma | CDMA1900 reverse |
| FO8Cdma | CDMA One 800 forward |
| RO8Cdma | CDMA One 800 reverse |
| FO19CDMA | CDMA One 1900 forward |
| RO19CDMA | CDMA One 1900 reverse |
| TCDMa | TD-SCDMA |

The selection of a standard influences the parameters weighting filter, channel bandwidth and spacing, resolution and video bandwidth, as well as detector and sweep time.

This command is an event which is why it is not assigned an *RST value and query.

:CALCulate<1|2>:MARKer<1 to 4>:FUNCtion:POWer:CFILter ON | OFF

This command switches the weighting filter for the selected standard on or off.

Example: " :CALC:MARK:FUNC:POW:CFIL ON "

Features: *RST value: OFF
 SCPI: device-specific

Mode: A-F

:CALCulate<1|2>:MARKer<1 to 4>:FUNCtion:SUMMery:STATe ON | OFF

This command switches the messages selected by the summary marker (eg RMS and MEAN) on and off. One or several measurements can be selected with the commands listed in the following and then switched jointly on and off with SUMMery:STATe.

Example: " :CALC:MARK:FUNC:SUMM:STAT ON "

Features: *RST value: OFF
 SCPI: device-specific

Mode: A-Z, VA

:CALCulate<1|2>:MARKer<1 to 4>:FUNCtion:SUMMary:MAXimum[:STATe] ON | OFF

This command switches on or off the measurement of the maximum of the absolute value.

Example: " :CALC:MARK:FUNC:SUMM:MAX ON "

Features: *RST value: OFF
SCPI: device-specific

Mode: VA

When the measurement is switched on, the summary marker is automatically activated (command `SUMMary:STATe` set to ON). When it is switched off, the summary marker remains switched on provided further measurements are selected. Otherwise the marker is switched off automatically.

:CALCulate<1|2>:MARKer<1 to 4>:FUNCtion:SUMMary:MAXimum:RESult?

This command queries the results of the measurement of the maximum of the absolute value. Results of average calculation and peak hold are queried with commands `...:MAXimum:AVERage:RESult?` and `...:MAXimum:PHOLd:RESult?`.

Example: " :CALC:MARK:FUNC:SUMM:MAX:RES? "

Features: *RST value: -
SCPI: device-specific

Mode: VA

This command is only a query and thus has no *RST value assigned.

:CALCulate<1|2>:MARKer<1 to 4>:FUNCtion:SUMMary:MAXimum:AVERage:RESult?

This command is used to query the results of the measurement of the maximum of the absolute value if the average is calculated using the command `:CALCulate<1|2>:MARKer<1 to 4>:FUNCtion:SUMMary:AVERage`.

Example: " :CALC:MARK:FUNC:SUMM:MAX:AVER:RES? "

Features: *RST value: -
SCPI: device-specific

Mode: VA

This command is only a query and thus has no *RST value assigned.

:CALCulate<1|2>:MARKer<1 to 4>:FUNCtion:SUMMary:MAXimum:PHOLd:RESult?

This command is used to query the results of the measurement of the maximum of the absolute value when the peak hold function is switched on with command `:CALCulate<1|2>:MARKer<1 to 4>:FUNCtion:SUMMary:PHOLd`.

Example: " :CALC:MARK:FUNC:SUMM:MAX:PHOL:RES? "

Features: *RST value: -
SCPI: device-specific

Mode: VA

This command is only a query and thus has no *RST value assigned.

:CALCulate<1|2>:MARKer<1 to 4>:FUNCTION:SUMMARY:PPEak[:STATe] ON | OFF

This command switches on or off the measurement of the positive peak value if the calculation and.

Example: " :CALC:MARK:FUNC:SUMM:PPE ON "

Features: *RST value: OFF
SCPI: device-specific

Mode: VA

When the measurement is switched on, the summary marker is automatically activated (command SUMMARY:STATe set to ON). When it is switched off, the summary marker remains switched on provided further measurements are selected. Otherwise the marker is switched off automatically.

:CALCulate<1|2>:MARKer<1 to 4>:FUNCTION:SUMMARY:PPEak:RESult?

This command is used to query the result of the measurement of the positive peak value. Results of average calculation and peak hold are queried with commands . . . :PPEak:AVERAge:RESult? and . . . :PPEak:PHOLd:RESult?.

Example: " :CALC:MARK:FUNC:SUMM:PPE:RES? "

Features: *RST value: -
SCPI: device-specific

Mode: VA

This command is only a query and thus has no *RST value assigned.

:CALCulate<1|2>:MARKer<1 to 4>:FUNCTION:SUMMARY:PPEak:AVERAge:RESult?

This command is used to query the result of the measurement of the positive peak value if the average is calculated using the command :CALCulate<1|2>:MARKer<1 to 4>:FUNCTION:SUMMARY:AVERAge.

Example: " :CALC:MARK:FUNC:SUMM:PPE:AVER:RES? "

Features: *RST value: -
SCPI: device-specific

Mode: VA

This command is only a query and thus has no *RST value assigned.

:CALCulate<1|2>:MARKer<1 to 4>:FUNCTION:SUMMARY:PPEak:PHOLd:RESult?

This command is used to query the result of the measurement of the positive peak value if the peak hold function is switched on with command :CALCulate<1|2>:MARKer<1 to 4>:FUNCTION:SUMMARY:PHOLd.

Example: " :CALC:MARK:FUNC:SUMM:PPE:PHOL:RES? "

Features: *RST value: -
SCPI: device-specific

Mode: VA

This command is only a query and thus has no *RST value assigned.

:CALCulate<1|2>:MARKer<1 to 4>:FUNCtion:SUMMary:MPEak[:STATe] ON | OFF

This command switches on or off the measurement of the negative peak value.

Example: " :CALC:MARK:FUNC:SUMM:MPE ON"

Features: *RST value: OFF
SCPI: device-specific

Mode: VA

When the measurement is switched on, the summary marker is automatically activated (command `SUMMary:STATe` set to ON). When it is switched off, the summary marker remains switched on provided further measurements are selected. Otherwise the marker is switched off automatically.

:CALCulate<1|2>:MARKer<1 to 4>:FUNCtion:SUMMary:MPEak:RESult?

This command queries the result of the measurement of the negative peak value. Results of average calculation and peak hold are queried with commands `...:MPEak:AVERage:RESult?` and `...:MPEak:PHOLd:RESult?`.

Example: " :CALC:MARK:FUNC:SUMM:MPE:RES?"

Features: *RST- value: -
SCPI: device-specific

Mode: VA

This command is only a query and thus has no *RST value assigned.

:CALCulate<1|2>:MARKer<1 to 4>:FUNCtion:SUMMary:MPEak:AVERage:RESult?

This command queries the result of the measurement of the negative peak value if the average is calculated using the command `:CALCulate<1|2>:MARKer<1 to 4>:FUNCtion:SUMMary:AVERage`.

Example: " :CALC:MARK:FUNC:SUMM:MPE:AVER:RES?"

Features: *RST- value: -
SCPI: device-specific

Mode: VA

This command is only a query and thus has no *RST value assigned.

:CALCulate<1|2>:MARKer<1 to 4>:FUNCtion:SUMMary:MPEak:PHOLd:RESult?

This command queries the result of the measurement of the negative peak value if the peak hold function is switched on with command `:CALCulate<1|2>:MARKer<1 to 4>:FUNCtion:SUMMary:PHOLd`.

Example: " :CALC:MARK:FUNC:SUMM:MPE:RES?"

Features: *RST- value: -
SCPI: device-specific

Mode: VA

This command is only a query and thus has no *RST value assigned.

:CALCulate<1|2>:MARKer<1 to 4>:FUNCtion:SUMMary:MIDDle[:STATe] ON | OFF

This command switches on or off the measurement of the arithmetical mean between positive and negative peak value.

Example: " :CALC:MARK:FUNC:SUMM:MIDD ON"

Features: *RST value: OFF
SCPI: device-specific

Mode: VA

When the measurement is switched on, the summary marker is automatically activated (command `SUMMary:STATe` set to ON). When it is switched off, the summary marker remains switched on provided further measurements are selected. Otherwise the marker is switched off automatically.

:CALCulate<1|2>:MARKer<1 to 4>:FUNCtion:SUMMary:MIDDle:RESult?

This command queries the result of the measurement of the arithmetical mean between positive and negative peak value. Results of average calculation and peak hold are queried with commands `...:MIDDle:AVERAge:RESult?` and `...:MIDDle:PHOLd:RESult?`.

Example: " :CALC:MARK:FUNC:SUMM:MIDD:RES? "

Features: *RST- value: -
SCPI: device-specific

Mode: VA

This command is only a query and thus has no *RST value assigned

:CALCulate<1|2>:MARKer<1 to 4>:FUNCtion:SUMMary:MIDDle:AVERAge:RESult?

This command queries the result of the measurement of the arithmetical mean between positive and negative peak value if the average is calculated using the command `:CALCulate<1|2>:MARKer<1 to 4>:FUNCtion:SUMMary:AVERAge`.

Example: " :CALC:MARK:FUNC:SUMM:MIDD:AVER:RES? "

Features: *RST- value: -
SCPI: device-specific

Mode: VA

This command is only a query and thus has no *RST value assigned

:CALCulate<1|2>:MARKer<1 to 4>:FUNCtion:SUMMary:MIDDle:PHOLd:RESult?

This command queries the result of the measurement of the arithmetical mean between positive and negative peak value if the peak hold function is switched on using the command `:CALCulate<1|2>:MARKer<1 to 4>:FUNCtion:SUMMary:PHOLd`.

Example: " :CALC:MARK:FUNC:SUMM:MIDD:PHOL:RES? "

Features: *RST- value: -
SCPI: device-specific

Mode: VA

This command is only a query and thus has no *RST value assigned

:CALCulate<1|2>:MARKer<1 to 4>:FUNCtion:SUMMary:RMS[:STATe] ON | OFF

This command switches on or off the measurement of the effective (rms) value of the total trace.

Example: " :CALC:MARK:FUNC:SUM:RMS ON "

Features: *RST value: OFF
SCPI: device-specific

Modes: A-Z, VA

When the measurement is switched on, the summary marker is automatically activated (command `SUMMary:STATe` set to ON). When it is switched off, the summary marker remains switched on provided further measurements are selected. Otherwise the marker is switched off automatically.

:CALCulate<1|2>:MARKer<1 to 4>:FUNCtion:SUMMary:RMS:RESult?

This command queries the result of the measurement of the mean value of the total trace. Results of average calculation and peak hold are queried with commands `...:RMS:AVERAge:RESult?` and `...:RMS:PHOLd:RESult?..`

Example: " :CALC:MARK:FUNC:SUMM:RMS:RES? "

Features: *RST- value: -
SCPI: device-specific

Modes: A-Z, VA

This command is only a query and thus has no *RST value assigned.

:CALCulate<1|2>:MARKer<1 to 4>:FUNCtion:SUMMary:RMS:AVERAge:RESult?

This command queries the result of the measurement of the mean value of the total trace if the average is calculated using the command `:CALCulate<1|2>:MARKer<1 to 4>:FUNCtion:SUMMary:AVERAge`.

Example: " :CALC:MARK:FUNC:SUMM:RMS:AVER:RES? "

Features: *RST- value: -
SCPI: device-specific

Modes: A-Z, VA

This command is only a query and thus has no *RST value assigned.

:CALCulate<1|2>:MARKer<1 to 4>:FUNCtion:SUMMary:RMS:PHOLd:RESult?

This command queries the result of the measurement of the mean value of the total trace if the peak hold function is switched on using the command `:CALCulate<1|2>:MARKer<1 to 4>:FUNCtion:SUMMary:PHOLd`.

Example: " :CALC:MARK:FUNC:SUMM:RMS:PHOL:RES? "

Features: *RST- value: -
SCPI: device-specific

Modes: A-Z, VA

This command is only a query and thus has no *RST value assigned.

:CALCulate<1|2>:MARKer<1 to 4>:FUNction:SUMMary:MEAN[:STATe] ON | OFF

This command switches on or off the measurement of the mean value of the total trace.

Example: " :CALC:MARK:FUNC:SUMM:MEAN ON "

Features: *RST value: OFF
SCPI: device-specific

Modes: A-Z, VA

When the measurement is switched on, the summary marker is automatically activated (command `SUMMary:STATe` set to ON). When it is switched off, the summary marker remains switched on provided further measurements are selected. Otherwise the marker is switched off automatically.

:CALCulate<1|2>:MARKer<1 to 4>:FUNction:SUMMary:MEAN:RESult?

This command queries the result of the measurement of the mean value of the total trace. Results of average calculation and peak hold are queried with commands `...:MEAN:AVERage:RESult?` and `...:MEAN:PHOLd:RESult?..`

Example: " :CALC:MARK:FUNC:SUMM:MEAN:RES? "

Features: *RST- value: -
SCPI: device-specific

Modes: A-Z, VA

This command is only a query and thus has no *RST value assigned.

:CALCulate<1|2>:MARKer<1 to 4>:FUNction:SUMMary:MEAN:AVERage:RESult?

This command queries the result of the measurement of the mean value of the total trace if the average is calculated using the command `:CALCulate<1|2>:MARKer<1 to 4>:FUNction:SUMMary:AVERage`.

Example: " :CALC:MARK:FUNC:SUMM:MEAN:AVER:RES? "

Features: *RST- value: -
SCPI: device-specific

Modes: A-Z, VA

This command is only a query and thus has no *RST value assigned.

:CALCulate<1|2>:MARKer<1 to 4>:FUNction:SUMMary:MEAN:PHOLd:RESult?

This command queries the result of the measurement of the mean value of the total trace if the peak hold function is switched on using the command `:CALCulate<1|2>:MARKer<1 to 4>:FUNction:SUMMary:PHOLd`.

Example: " :CALC:MARK:FUNC:SUMM:MEAN:PHOL:RES? "

Features: *RST- value: -
SCPI: device-specific

Modes: A-Z, VA

This command is only a query and thus has no *RST value assigned.

:CALCulate<1|2>:MARKer<1 to 4>:FUNCtion:SUMMary:PHOLd ON | OFF

This command switches on or off the peak-hold function.

Example: " :CALC:MARK:FUNC:SUMM:PHOL ON "

Features: *RST value: OFF
SCPI: device-specific

Modes: A-Z, VA

The peak-hold function is reset by switching off and on, again.

:CALCulate<1|2>:MARKer<1 to 4>:FUNCtion:SUMMary:AVERAge ON | OFF

This command switches the calculation of the average value on or off.

Example: " :CALC:MARK:FUNC:SUMM:AVER ON "

Features: *RST value: OFF
SCPI: device-specific

Modes: A-Z, VA

The calculation of the average is reset by switching off and on, again.

:CALCulate<1|2>:MARKer<1 to 4>:FUNCtion:SUMMary:AOFF

This command switches off all measuring functions.

Example: " :CALC:MARK:FUNC:SUMM:AOFF "

Features: *RST value: -
SCPI: device-specific

Modes: A-Z, VA

This command is an "event" and therefore has no *RST value assigned and no query.

:CALCulate<1|2>:MARKer<1 to 4>:FUNCtion:CENTer

This command sets the center frequency to that of the current marker.

Example: " :CALC:MARK:FUNC:CENT "

Features: *RST value: -
SCPI: device-specific

Mode: A-F

This command is an "event" and therefore has no *RST value assigned and no query.

:CALCulate<1|2>:MARKer<1 to 4>:FUNCtion:CSTep

This command sets the step width of the center frequency to the x-value of the current marker.

Example: " :CALC:MARK:FUNC:CST "

Features: *RST value: -
SCPI: device-specific

Mode: A-F

This command is an "event" and therefore has no *RST value assigned and no query.

:CALCulate<1|2>:MARKer<1 to 4>:FUNCtion:STARt

This command sets the start frequency to the frequency of the current marker.

Example: " : CALC : MARK : FUNC : STAR "

Features: *RST value: -
SCPI: device-specific

Mode: A-F

This command is an "event" which is why it is not assigned an *RST value and has no query.

:CALCulate<1|2>:MARKer<1 to 4>:FUNCtion:STOP

This command sets the stop frequency to the frequency of the current marker.

Example: " : CALC : MARK : FUNC : STOP "

Features: *RST value: -
SCPI: device-specific

Mode: A-F

This command is an "event" which is why it is not assigned an *RST value and has no query.

:CALCulate<1|2>:MARKer<1 to 4>:FUNCtion:MSTep

This command sets the marker step width to the x-value of the current marker.

Example: " : CALC : MARK : FUNC : MST "

Features: *RST value: -
SCPI: device-specific

Modes: A, VA

This command is an "event" which is why it is not assigned an *RST value and has no query.

:CALCulate<1|2>:MARKer<1 to 4>:FUNCtion:REFerence

This command sets the reference level to that of the current marker.

Example: " : CALC : MARK : FUNC : REF "

Features: *RST value: -
SCPI: device-specific

Modes: A, VA

This command is an "event" and therefore has no *RST value assigned and no query.

This command is an <Event> and has therefore neither *RST value nor query. The numeric suffixes in CALCulate<1|2> and MARKer<1 to 4> are not significant.

CALCulate:MATH Subsystem

The CALCulate:MATH - subsystem allows to process data from the SENSE-subsystem in numeric expressions.

| COMMAND | PARAMETERS | UNIT | COMMENT |
|---|---------------------|----------|---------|
| CALCulate<1 2> :MATH<1 to 4> [:EXPRession] [:DEFine] :STATe | <expr> <Boolean> | -- -- | |

:CALCulate<1|2>:MATH<1 to 4>[:EXPRession][:DEFine] <expr>

This command defines the mathematical expression for relating traces and reference line. Command CALCulate:MATH:STATe switches the mathematical relation of traces on or off .

Parameter: <expr> ::= 'OP1 - OP2 [+ RLINE]'
 OP1 ::= TRACE1 | TRACE2 | TRACE3 | TRACE4
 OP2 ::= TRACE1 | TRACE2 | TRACE3 | TRACE4 | RLINE

Examples: " :CALC:MATH1 (TRACE1 - TRACE3 + RLINE) "
 " :CALC:MATH4 (TRACE4 - RLINE) "

Features: *RST value: -
 SCPI: conforming

Modes: A, VA

The operand [+ RLINE] may be used only if OP2 is different from RLINE. The numeric suffix in CALCULATE<1 | 2> is not significant. The numeric suffix in MATH<1 to 4> denotes the trace where the result of the mathematical operation is stored. The number must be identical to the number of the operand OP1.

:CALCulate<1|2>:MATH<1 to 4>:STATe ON | OFF

This command switches the mathematical relation of traces on or off.

Example: " :CALC:MATH1:STAT ON"

Features: *RST value: OFF
 SCPI: conforming

Modes: A, VA

The numeric suffix in CALCULATE<1 | 2> is not significant. The numeric suffix in MATH<1 to 4> denotes the trace which the command refers to.

CALCulate:X and CALCulate:UNIT Subsystem

The CALCulate:X and CALCulate:Unit subsystems define the units for vector signal analyzer mode and power measurements.

| COMMAND | PARAMETERS | UNIT | COMMENT |
|---|---|------|--|
| CALCulate<1 2> :X :UNIT :TIME :UNIT :ANGLE :POWer | S SYM DEG RAD DBM V W DB PCT UNITLESS DBPW WATT DBUV DBMV VOLT DBPT DBUA AMPere DBUV_MHZ DBMV_MHZ DBUA_MHZ DBUV_M DBUA_M DBUV_MMHZ DBUA_MMHZ | | Vector Signal Analysis Vector Signal Analysis |

:CALCulate<1|2>:X:UNIT:TIME S | SYM

This command selects seconds or symbols as an x-axis unit.

Example: " :CALC:X:UNIT:TIME S "

Features: *RST value: S
SCPI: device-specific

Mode: VA-D

:CALCulate<1|2>: UNIT:ANGLE DEG | RAD

This command selects the unit for angular measurement.

Example: " :CALC:UNIT:ANGL DEG "

Features: *RST- value: RAD
SCPI: device-specific

Mode: VA-D

:CALCulate<1|2>: UNIT:POWer DBM | V | W | DB | PCT | DBPT | UNITLESS | DBPW | WATT | DBUV | DBMV | VOLT | DBUA | AMPere | DBUV_MHZ | DBMV_MHZ | DBUA_MHZ | DBUV_M | DBUA_M | DBUV_MMHZ | DBUA_MMHZ

This command selects the unit for power.

Example: " :CALC:UNIT:POW DBM "

Features: *RST value: _
SCPI: device-specific

Modes: A, VA

The units DEG, RAD, S, and HZ are available only in the vector analyzer mode.

DBUV_MHZ and DBUA_MHZ denote the units DBUV/MHZ or DBUA/MHZ.

CALibration Subsystem

The commands of the CALibration subsystem perform instrument calibrations.

| COMMAND | PARAMETERS | UNIT | COMMENT |
|-----------------|------------|------|--|
| CALibration | | | |
| [:ALL]? | -- | -- | query only |
| :BANDwidth | | | |
| [:RESolution]? | -- | -- | query only |
| :BWIDth | | | |
| [:RESolution]? | -- | -- | query only |
| :IQ? | -- | -- | query only / Vector Signal Analysis |
| :LDETEctor? | -- | -- | query only |
| :LOSuppression? | -- | -- | query only |
| :PPEak? | -- | -- | query only FSEM/FSEK only |
| :SHORT? | -- | -- | query only |
| :STATe | <Boolean> | -- | |

::CALibration[:ALL]?

This command performs a complete calibration of the instrument. A "0" is returned if the calibration was successful.

Example: "CAL?"

Features: *RST value: -
SCPI: conforming

Modes: A, VA, BTS, MS

:CALibration:BANDwidth | BWIDth[:RESolution]?

This command performs a calibration of the filter bandwidths. A "0" is returned if the calibration was successful.

Example: ":CAL:BAND?"

Features: *RST value: -
SCPI: device-specific

Modes: A, VA, BTS, MS

:CALibration:IQ?

This command performs a calibration of the vector signal analyzer. A "0" is returned if the calibration was successful.

Example: ":CAL:IQ?"

features: *RST value: -
SCPI: device-specific

Modes: VA, BTS, MS

:CALibration:LDETECTOR?

This command performs a calibration of the log module's characteristic and of the detectors. A "0" is returned if the calibration was successful.

Example: " :CAL:LDET? "
Features: *RST value: -
 SCPI: device-specific
Modes: A, VA, BTS, MS

:CALibration:LOSuppression?

This command performs a calibration of the local oscillator suppression. . A "0" is returned if the calibration was successful.

Example: " :CAL:LOS? "
Features: *RST value: -
 SCPI: device-specific
Modes: A, VA, BTS, MS

This command is only valid by model '30 instruments or by instruments which have been retrofitted.

:CALibration:PPEAK?

This command performs a calibration of the tracking YIG filter (preselector peaking). A "0" is returned if the calibration was successful.

Example: " :CAL:PPE? "
Features: *RST value: -
 SCPI: device-specific
Modes: A

This command is only valid by the models FSEM and FSEK.

:CALibration:SHORT?

This command performs a short calibration. A "0" is returned if the calibration was successful.

Example: " :CAL:SHOR? "
Features: *RST value: -
 SCPI: device-specific
Modes: A, VA, BTS, MS

:CALibration:STATE ON | OFF

This command determines whether (ON) or not (OFF) the current calibration data are taken into consideration.

Example: " :CAL:STAT OFF "
Features: *RST value: -
 SCPI: conforming
Modes: A, VA, BTS, MS

CONFigure Subsystem

The CONFigure subsystem contains commands for configuring complex measurement tasks, like those provided by the options GSM BTS Analyzer (FSE-K11) or GSM MS Analyzer (FSE-K10). The CONFigure subsystem is closely linked to the functions of the FETCH and READ subsystems, where the measurement cycles are started and/or the results of the measurements are queried.

CONFigure:BTS Subsystem

This subsystem provides the commands for configuring the GSM BTS Analyzer mode (Option FSE-K11) for analyzing the behavior of base stations corresponding to the standards P-GSM, E-GSM, R-GSM, DCS1800 or PCS1900. EDGE measurement require option FSE-K21, and tests in the GSM 850 MHz band option FSE-K31.

| COMMAND | PARAMETERS | UNIT | COMMENT |
|---------------|---|------|----------------------------------|
| CONFigure | | | |
| [:BTS] | | | Option FSE-K11/K21/31 query only |
| :MEASurement? | | | query only |
| :ARFCn | <numeric_value> | -- | |
| :AUTO | ONCE | | no query |
| :LIMit | | | |
| :PPEak | <numeric_value> | DEG | |
| :PRMS | <numeric_value> | DEG | |
| :EVMRms | <numeric_value> | PCT | |
| :EVMPeak | <numeric_value> | PCT | |
| :OSUPpress | <numeric_value> | DB | |
| :PERCentile | <numeric_value> | PCT | |
| :FREQuency | <numeric_value> | ppm | |
| :STANdard | <Boolean> | | |
| :POWER | | | |
| :CLASs | <numeric_value> M1 M2 M3 P1 EG1 EG2 EG3 | -- | |
| :COUPled | <Boolean> | | |
| :STATic | <numeric_value> | -- | |
| :DYNamic | <numeric_value> | -- | |
| :EXPEcted | <numeric_value> | DBM | |
| :LIMit | <numeric_value> | DBM | |
| :SINGle | | | |
| [:STATe] | <Boolean> | | |
| :CLEar | -- | | no query |
| :CHANnel | | | |
| :SLOT | <numeric_value> | -- | no query |
| :AUTO | ONCE | | |
| :TSC | <numeric_value> | -- | no query |
| :AUTO | <Boolean> | | |
| :SFH | <Boolean> | | |
| :NETWork | | | |
| [:TYPE] | PGSM PGSM900 EGSM EGSM900 DCS GSM1800 PCS GSM1900 RGSM RGSM900 GSM850 | | |
| :PHASe | 1 2[,PLUS] | | |
| :COSiting | <Boolean> | | |
| :TXSupp | <Boolean> | | no query |
| :PRESet | -- | | |
| :SWEeptime | STANdard AUTO | | |
| :MTYPE | GMSK EDGE | | |
| :STYPE | NORMal MICRo PICO | | |

:CONFigure[:BTS]:MEASurement?

This command queries which measurement is currently set.

| | |
|------------|------------------------|
| PFError | Phase-/Frequency Error |
| MACCuracy | Modulation Accuracy |
| POWer | Carrier Power |
| PTEMplate | Power v. Time |
| MODulation | Modulation Spectrum |
| SWITching | Transient Spectrum |
| SPURious | Spurious |

Example: " :CONF:MEAS? " Answer: "PFER"

Features: *RST-value: -
SCPI: device-specific

Mode: BTS

This command is a query and has therefore no *RST value assigned.

:CONFigure[:BTS]:ARFCn <numeric_value>

This command selects the number of the transmission channel of the base station.

| | | | |
|-------------------|--------------------|-----------------------|--------------------------|
| Parameter: | <numeric_value>::= | 1 to 124 | (P-GSM phase I/II) |
| | | 0 to 124, 975 to 1023 | (E-GSM) |
| | | 0 to 124, 955 to 1023 | (R-GSM) |
| | | 512 to 885 | (DCS1800 phase I/II/II+) |
| | | 512 to 810 | (PCS1900) |
| | | 128 to 251 | (GSM850) |

Example: " :CONF:ARFC 67"

Features: *RST value: 1 (P-GSM phase I/II)
 0 (E-GSM; R-GSM)
 512 (DCS1800 phase I/II/II+)
 512 (PCS1900)
 128 (GSM850)
SCPI: device-specific

Mode: BTS

:CONFigure[:BTS]:ARFCn:AUTO ONCE

This command is used to search for the channel number of the transmission channel of the base station automatically. This requires only one channel to be active.

Example: " :CONF:ARFC:AUTO ONCE"

Features: *RST value: --
SCPI: device-specific

Mode: BTS

This command is an event and thus has no query and no *RST value assigned.

:CONFigure[:BTS]:LIMit:PPEak <numeric_value>

This command determines the phase error limits in degrees for the phase/frequency measurement (peak value).

Example: " :CONF:LIM:PPE 66 "

Feature: *RST value: depending on standard
SCPI: device-specific

Mode: BTS

:CONFigure[:BTS]:LIMit:PRMS <numeric_value>

This command determines the phase error limits in degrees for the phase/frequency measurement (mean value).

Example: " :CONF:LIM:PRMS 22 "

Feature: *RST value: depending on standard
SCPI: device-specific

Mode: BTS

Betriebsart: BTS

CONFigure[:BTS]:LIMit:EVMRms<numeric_value>

This command determines the value in percent for the error limits of error vector magnitude measurement with RMS weighting.

Example: " :CONF:LIM:EVMR 40 "

Features: *RST value depending on the standard
SCPI: device-specific

Mode: BTS

CONFigure[:BTS]:LIMit:EVMPeak<numeric_value>

This command determines the value in percent for the error limits of error vector magnitude measurement with PEAK weighting.

Example: " :CONF:LIM:EVMP 30 "

Features: *RST value depending on the standard
SCPI: device-specific

Mode: BTS

:CONFigure[:BTS]:LIMit:OSUPpress<numeric_value>

This command defines the limit for the origin offset suppression.

Example: " :CONF:LIM:OSUP 30 "

Features: *RST value depending on the standard
SCPI: device-specific

Mode: BTS

:CONFigure[:BTS]:POWer:STATic 0 to 6

This command defines the static power control level of the base station.

Example: " :CONF:POW:STAT 3"

Features: *RST value: 0
SCPI: device-specific

Mode: BTS

:CONFigure[:BTS]:POWer:DYNamic 0 to 15

This command defines the dynamic power control level of the base station.

Example: " :CONF:POW:DYN 5"

Features: *RST value: 0
SCPI: device-specific

Mode: BTS

:CONFigure[:BTS]:POWer:EXPected <numeric_value>

This command enters directly the rated output level of the base station specified by the manufacturer.

Example: " :CONF:POW:EXP 43DBM"

Features: *RST value: 46 dBm (P-GSM phase I/II, E-GSM, R-GSM)
43 dBm (DCS1800, PCS1900)
SCPI: device-specific

Mode: BTS

:CONFigure[:BTS]:POWer:LIMit <numeric_value>

This command defines the level for the selection of level-dependent limit lines.

Example: " :CONF:POW:LIM 65DBM"

Feature: *RST value: depending on standard
SCPI: device-specific

Mode: BTS

This command is only available for the setting :CONFigure[:BTS]:POWer:COUPled OFF.

:CONFigure[:BTS]:POWer:SINGle[:STATe] ON | OFF

This command switches single measurement of carrier power on and off.

Example: " :CONF:POW:SING ON"

Feature: *RST value: OFF
SCPI: device-specific

Mode: BTS

:CONFigure[:BTS]:POWer:SINGle:CLEar

This command clears the table containing the single-step carrier power measurements.

Example: " : CONF : POW : SING : CLE "

Features: *RST value: --
SCPI: device-specific

Mode: BTS

This command is an event and has therefore neither *RST value nor query.

:CONFigure[:BTS]:CHANnel:SLOT 0 to 7

This command selects the slot number within a transmission frame of the base station.

Example: " : CONF : CHAN : SLOT 3 "

Features: *RST value: 0
SCPI: device-specific

Mode: BTS

On changing the slot number, the number of the midamble (TSC) is automatically adapted to the slot.

:CONFigure[:BTS]:CHANnel:SLOT:AUTO ONCE

This command automatically searches for the slot number within a transmission frame of the base station. This requires only one slot to be active.

Example: " : CONF : CHAN : SLOT : AUTO ONCE "

Features: *RST value: --
SCPI: device-specific

Mode: BTS

This command is an event and thus has no query and no *RST value assigned.

:CONFigure[:BTS]:CHANnel:SFH ON | OFF

This command defines whether the base station uses slow frequency hopping or not.

Example: " : CONF : CHAN : SFH ON "

Features: *RST value: OFF
SCPI: device-specific

Mode: BTS

This command is available only when spurious or transient spectrum measurement is selected. The settings for spurious measurement are independent from those selected for transient spectrum.

:CONFigure[:BTS]:CHANnel:TSC:AUTO ON | OFF

This command couples the midamble (training sequence TSC_0 to 7) to the slot, i.e. if the slot number is changed the training sequence in the ON state is automatically adapted. In the OFF state, the training sequence set is conserved even if the slot number is changed.

Example: " :CONF:CHAN:TSC:AUTO ON"

Features: *RST value: ON
SCPI: device-specific

Mode: BTS

:CONFigure[:BTS]:CHANnel:TSC 0 to 7

This command selects the midamble (training sequence TSC_0 to 7) of the active slot.

Example: " :CONF:CHAN:TSC 3"

Features: *RST value: 0
SCPI: device-specific

Mode: BTS

:CONFigure[:BTS]:NETWork[:TYPE] PGSM | PGSM900 | EGSM | EGSM900 | DCS |GSM1800 | PCS | GSM1900 | RGSM | RGSM900 | GSM850

This command selects the standard type according to which the base station will work.

Example: " :CONF:NETW DCS"

Features: *RST value: GSM
SCPI: device-specific

Mode: BTS

:CONFigure[:BTS]:NETWork:PHASe 1|2 [,PLUS]

This command selects the phase of the standard according to which the base station will work.

Example: " :CONF:NETW:PHAS 2"

Features: *RST value: 1
SCPI: device-specific

Mode: BTS

:CONFigure[:BTS]:COSiting ON | OFF

This command selects whether the base station has the "cositing" feature.

Example: " :CONF: COS ON"

Features: *RST value: OFF
SCPI: device-specific

Mode: BTS

This command is available only if spurious emission measurement is selected.

:CONFigure[:BTS]:TXSupp ON | OFF

This command defines that an additional carrier suppression of min. 20dB is taken into account for the measurement. If there is already suppression, a more sensitive setting of the instrument is selected.

Example: " :CONF:TXS ON"
Features: *RST value: OFF
 SCPI: device-specific
Mode: BTS

For measurements in the RX-band the value is automatically set to ON.

:CONFigure[:BTS]:PRESet

This command resets the parameters for the standard selected to their default values (DEFAULT SETTINGS).

Example: " :CONF:PRES "
Features: *RST value: --
 SCPI: device-specific
Mode: BTS

This command is an event and has thus no query and no *RST value assigned.

:CONFigure[:BTS]:SWEeptime STANdard | AUTO

This command selects the sweep-time computing mode for the spurious measurement:

Example: " :CONF:SWE AUTO "
Feature: *RST value: STANdard
 SCPI: device-specific
Mode: BTS

STANdard The computation of the sweep time is based on a worst-case estimation
 AUTO The sweep time is reduced by a factor of 8 (assuming all slots are on).

CONFigure[:BTS]:MTYPe GMSK | EDGE

This command selects the modulation type (GMSK or EDGE (8PSK)).

Example: " :CONF:MTYP EDGE "
Features: **RST value: GMSK
 SCPI: device-specific
Mode: BTS

CONFigure[:BTS]:STYPe NORMal | MICRo | PICO

This comman selects the type of base station.

Example: " :CONF:STYP PICO "
Features: *RST value: NORM
 SCPI: device-specific
Mode: BTS

CONFigure:BURSt Subsystem

This subsystem provides the commands for configuring the measurements in the GSM BTS Analyzer mode (option FSE-K11) or GSM MS Analyzer mode (option FSE-K10) which are performed on individual bursts. (carrier power, phase/frequency error, power vs. time).

| COMMAND | PARAMETERS | UNIT | COMMENT |
|--------------|-------------------------------|------|--|
| CONFigure | | | |
| :BURSt | | | |
| :PFERror | | | no query, Option FSE-K11 or FSE-K10 & FSE-B7 |
| [:IMMediate] | -- | -- | |
| :COUNT | <numeric_value> | -- | Option FSE-K11 or FSE-K10 |
| :CONDition | NORMal EXTReMe | | Option FSE-K11 or FSE-K10 |
| :MACCuracy | | | no query |
| [:IMMediate] | -- | -- | |
| :COUNT | <numeric_value> | -- | Option FSE-K11 or FSE-K10 & FSE-B7 |
| :CONDition | NORMal EXTReMe | | |
| :POWer | | | |
| [:IMMediate] | -- | | No query |
| :COUNT | <numeric_value> | -- | |
| :CONDition | NORMal EXTReMe | -- | |
| :PTEmplate | | | Option FSE-K11 or FSE-K10 |
| [:IMMediate] | -- | | no query |
| :COUNT | <numeric_value> | -- | |
| :SELect | FULL TOP RISing FALLing | -- | |
| :REFerence | | | Option FSE-K11 or FSE-K10 |
| :AUTO | <Boolean> | | no query |

:CONFigure:BURSt:PFERror[:IMMediate]

This command selects measurement of the phase and frequency error of the base station or mobile.

Example: " : CONF : BURS : PFER "

Features: *RST value: --
SCPI: device-specific

Modes: BTS, MS

This command is an event and thus has no query and no *RST value assigned.

It is available only in conjunction with option GSM BTS Analyzer FSE-K11 or option GSM MS Analyzer, FSE-K10, and Vector Signal Analysis, FSE-B7.

:CONFigure:BURSt:PFERror:COUNT 1 to 1000

This command sets the number of bursts used for the determination of average and maximum value.

Example: " : CONF : BURS : PFER : COUN 100 "

Features: *RST value: 500 (GSM/DCS1800 Phase I)
200 otherwise
SCPI: device-specific

Modes: BTS, MS

It is available only in conjunction with option GSM BTS Analyzer FSE-K11 or option GSM MS Analyzer, FSE-K10, and Vector Signal Analysis, FSE-B7.

:CONFigure:BURSt:PFERror:CONDition NORMal | EXTReMe

This command defines the conditions for phase-frequency measurement.

Example: " :CONF: BURS: PFER: COND EXTR "

Features: *RST value: NORMal
SCPI: device-specific

Modes: BTS, MS

:CONFigure:BURSt:MACCuracy[:IMMediate]

This command selects measurement of the measurement accuracy of the base station or mobile.

Example: " :CONF: BURS: MACC "

Features: *RST value: --
SCPI: device-specific

Modes: BTS, MS

This command is an event and thus has no query and no *RST value assigned.

It is available only in conjunction with option GSM BTS Analyzer FSE-K11 or option GSM MS Analyzer, FSE-K10, and Vector Signal Analysis, FSE-B7.

:CONFigure:BURSt:MACCuracy:COUNt 1 to 1000

This command sets the number of bursts used for the determination of average and maximum value.

Example: " :CONF: BURS: MACC: COUN 100 "

Features: *RST value: 1
SCPI: device-specific

Modes: BTS, MS

It is available only in conjunction with option GSM BTS Analyzer FSE-K11 or option GSM MS Analyzer, FSE-K10, and Vector Signal Analysis, FSE-B7.

:CONFigure:BURSt:MACCuracy:CONDition NORMal | EXTReMe

This command defines the conditions for modulation accuracy measurement.

Example: " :CONF: BURS: MACC: COND EXTR "

Features: *RST value: NORMal
SCPI: device-specific

Modes: BTS, MS

:CONFigure:BURSt:POWer[:IMMediate]

This command selects measurement of the average carrier power of the base station or mobile.

Example: " :CONF: BURS: POW "

Features: *RST value: --
SCPI: device-specific

Modes: BTS, MS

This command is an event and thus has no query and no *RST value assigned.

:CONFigure:BURSt:POWer:COUNT 1 to 1000

This command sets the number of bursts used for the determination of measured values.

Example: " :CONF: BURS: POW: COUN 100 "

Features: *RST value: 500 (GSM/DCS1800 phase I)
200 otherwise
SCPI: device-specific

Modes: BTS, MS

:CONFigure:BURSt:POWer:CONDition NORMAl | EXTReme

This command defines the conditions for power measurement.

Example: " :CONF: BURS: POW: COND EXTR "

Features: *RST value: NORMAl
SCPI: device-specific

Modes: BTS, MS

:CONFigure:BURSt:PTEMPlate[:IMMediate]

This command selects measurement of power of the base station or mobile vs. time.

Example: " :CONF: BURS: PTEM "

Features: *RST value: --
SCPI: device-specific

Modes: BTS, MS

This command is an event and thus has no query and no *RST value assigned.

:CONFigure:BURSt:PTEMPlate:COUNT 1 to 1000

This command defines the number of bursts used for determining the measured value.

Example: " :CONF: BURS: PTEM: COUN 100 "

Features: *RST value: 500 (GSM/DCS1800 phase I)
200 otherwise
SCPI: device-specific

Modes: BTS, MS

:CONFigure:BURSt:PTEMplate:SElect FULL | TOP | RISing | FALLing

This command defined the burst section to be measured.

Example: " :CONF:BURS:PTEM:SEL TOP "

Features: *RST value: FULL
 SCPI: device-specific

Modes: BTS, MS

:CONFigure:BURSt:REFerence:AUTO ON | OFF

This command switches between automatic and user-activated preview of power versus time. When switched to AUTO, the preview is always performed, when switched to OFF it is omitted. Note: see READ:BURSt:REF:IMM

Example: " :CONF:BURS:REF:AUTO ON "

Feature: *RST value: AUTO
 SCPI: device-specific

Mode: BTS, MS

CONFigure:MS Subsystem

This subsystem provides the commands for configuring the GSM MS Analyzer mode (Option FSE-K10/FSE-K20) for analyzing the behavior of mobiles corresponding to the standards P-GSM, E-GSM, R-GSM, DCS1800 or PCS1900. EDGE measurement require option FSE-K20, and tests in the GSM 850 MHz band option FSE-K30.

| COMMAND | PARAMETERS | UNIT | COMMENT |
|---------------|---|------|------------------------|
| CONFigure | | | |
| [:MS] | | | option FSE-K10/K20/K30 |
| :MEASurement? | | | query only |
| :ARFCn | <numeric_value> | -- | |
| :AUTO | ONCE | | no query |
| :LIMit | | | |
| :PPEak | <numeric_value> | DEG | |
| :PRMS | <numeric_value> | DEG | |
| :EVMRms | <numeric_value> | PCT | |
| :EVMPeak | <numeric_value> | PCT | |
| :OSUPpress | <numeric_value> | DB | |
| :PERCentile | <numeric_value> | PCT | |
| :FREQuency | <numeric_value> | ppm | |
| :STANdard | <Boolean> | | |
| :POWer | | | |
| :CLASs | <numeric_value> EG1 EG2 EG3 M1 M2 M3 P1 | -- | |
| :COUPled | <Boolean> | -- | |
| :LEVel | <numeric_value> | DBM | |
| :LIMit | <numeric_value> | DBM | |
| :EXPEcted | <numeric_value> | | no query |
| :SINGle | | | |
| [:STATe] | <Boolean> | | |
| :CLEar | -- | | no query |
| :SMALI | <Boolean> | | |
| :CHANnel | | | |
| :SFH | <Boolean> | -- | |
| :TSC | <numeric_value> | | |
| :NETWork | | | |
| [:TYPE] | PGSM PGSM900 EGSM EGSM900 DCS GSM1800 PCS GSM1900 RGSM RGSM900 GSM850 | | |
| :PHASe | 1 2[,PLUS] | | |
| :TXSupp | <Boolean> | | no query |
| :PRESet | -- | | |
| :SWEeptime | STANdard AUTO | | |
| :MTYPE | GMSK EDGE | | |

:CONFigure[:MS]:MEASurement?

This command queries which measurement is currently set.

| | |
|------------|------------------------|
| PFError | Phase-/Frequency Error |
| MAccuracy | Modulation Accuracy |
| POWer | Carrier Power |
| PTEmplate | Power v. Time |
| MODulation | Modulation Spectrum |
| SWITching | Transient Spectrum |
| SPURious | Spurious |

Example: " :CONF:MEAS? " Answer: "PFER"

Features: *RST value: -
SCPI: device specific

Mode: MS

This command is a query and has therefore no *RST value assigned.

:CONFigure[:MS]:ARFCn <numeric_value>

This command selects the number of the transmission channel of the mobile.

| | | | |
|-------------------|--------------------|-----------------------|--------------------------|
| Parameter: | <numeric_value>::= | 1 to 124 | (P-GSM phase I/II) |
| | | 0 to 124, 975 to 1023 | (E-GSM) |
| | | 0 to 124, 955 to 1023 | (R-GSM) |
| | | 512 to 885 | (DCS1800 phase I/II/II+) |
| | | 512 to 810 | (PCS1900) |
| | | 128 to 251 | (GSM850) |

Example: " :CONF:ARFC 67 "

Features: *RST value: 1 (P-GSM phase I/II)
 0 (E-GSM; R-GSM)
 512 (DCS1800 phase I/II/II+)
 512 (PCS1900)
 128 (GSM850)
SCPI: device-specific

Mode: MS

:CONFigure[:MS]:ARFCn:AUTO ONCE

This command selects automatically the transmission channel of the mobile.

Example: " :CONF:ARFC:AUTO ONCE "

Features: *RST value: -
SCPI: device-specific

Mode: MS

:CONFigure[:MS]:LIMit:PPEak <numeric_value>

This command determines the phase error limits in degrees for the phase/frequency measurement (peak value).

Example: " :CONF:LIM:PPE 66 "

Feature: *RST value: depending on standard
SCPI: device-specific

Mode: MS

:CONFigure[:MS]:LIMit:PRMS <numeric_value>

This command determines the phase error limits in degrees for the phase/frequency measurement (mean value).

Example: " :CONF:LIM:PRMS 22 "

Feature: *RST value: depending on standard
SCPI: device-specific

Mode: MS

:CONFigure[:MS]:LIMit:EVMRms<numeric_value>

This command determines the value in percent for the error limits of error vector magnitude measurement with RMS weighting.

Example: " :CONF:LIM:EVMR 40 "

Features: *RST value depending on the standard
SCPI: device-specific

Mode: BTS

:CONFigure[:MS]:LIMit:EVMPeak<numeric_value>

This command determines the value in percent for the error limits of error vector magnitude measurement with PEAK weighting.

Example: " :CONF:LIM:EVMP 30 "

Features: *RST value depending on the standard
SCPI: device-specific

Mode: BTS

:CONFigure[:MS]:LIMit:OSUPpress<numeric_value>

This command defines the limit for the origin offset suppression.

Example: " :CONF:LIM:OSUP 30 "

Features: *RST value depending on the standard
SCPI: device-specific

Mode: BTS

:CONFigure[:MS]:LIMit:PERCentile<numeric_value>

This command defines the limit for the 95% percentile.

Example: " :CONF:LIM:PERC 30 "

Features: *RST value depending on the standard
SCPI: device-specific

Mode: BTS

:CONFigure[:MS]:LIMit:FREQuency <numeric_value>

This command determines the frequency error limits in ppm for the phase/frequency measurement.

Example: " :CONF:LIM:FREQ 36 "

Feature: *RST value: depending on standard
SCPI: device-specific

Mode: MS

:CONFigure[:MS]:LIMit:STANdard ON | OFF

This command switches between user-defined (OFF) and standard-defined (ON) limit values.

Example: " :CONF:LIM:STAN ON "

Feature: *RST value: ON
SCPI: device-specific

Mode: MS

:CONFigure[:MS]:POWer:CLASs <numeric_value> | EG1 | EG2 | EG3

This command defines the power class of the mobile.

Parameter: <numeric_value> ::= 1 to 5 (P-GSM phase I)
2 to 5 (P-GSM phase II, R-GSM850)
2 to 5 (E-GSM; R-GSM)
1 to 2 (DCS1800 phase I)
1 to 3 (DCS1800 phase II/II+)
1 to 3 (PCS1900)

Example: " :CONF:POW:CLAS 4 "

Features: *RST value: 2 (P-GSM phase I/II, E-GSM, R-GSM, R-GSM850)
1 (DCS1800, PCS1900)
SCPI: device-specific

Mode: MS

:CONFigure[:MS]:POWer:COUPlEd ON | OFF

This command switches between user-defined (OFF) and standard-defined (ON) level values.

Example: " :CONF:POW:COUP ON"

Feature: *RST value: ON standard
OFF user-defined
SCPI: device-specific

Mode: MS

:CONFigure[:MS]:POWer:LEVel 0 to 31

This command defines the power control level of the mobile.

Example: " :CONF:POW:LEV 5"

Features: *RST value: 2 (P-GSM Phase I/II, E-GSM, R-GSM, GSM850)
0 (DCS1800, PCS1900)
SCPI: device-specific

Mode: MS

:CONFigure[:MS]:POWer:LIMit <numeric_value>

This command defines the level for the selection of level-dependent limit lines.

Example: " :CONF:POW:LIM 65DBM"

Feature: *RST value: depending on standard
SCPI: device-specific

Mode: MS

This command is only available for the setting :CONFigure[:MS]:POWer:COUPlEd OFF.

:CONFigure[:MS]:POWer:EXPEcted <numeric_value>

This command enters directly the rated output level of the mobile.

Example: " :CONF:POW:EXP 43DBM"

Features: *RST value: GMSK:
39 dBm (P-GSM Phase I/II, E-GSM, R-GSM, GSM850)
30 dBm (DCS1800, PCS1900)
EDGE
33 dBm (P-GSM Phase I/II, E-GSM, R-GSM, GSM850)
30 dBm (DCS1800, PCS1900)
SCPI: device-specific

Mode: MS

:CONFigure[:MS]:POWer:SINGle[:STATe] ON | OFF

This command switches single measurement of carrier power on and off.

Example: " :CONF:POW:SING ON"
Feature: *RST value: OFF
 SCPI: device-specific
Mode: MS

:CONFigure[:MS]:POWer:SINGle:CLEar

This command clears the table containing the single-step carrier power measurements.

Example: " :CONF:POW:SING:CLEAR"
Feature: *RST value: --
 SCPI: device-specific
Mode: MS

This command is an event and has therefore neither *RST value nor query.

:CONFigure[:MS]:POWer:SMAL ON | OFF

This command switches the limits for spurious measurement in the RGSM range. It is only available for phase 2+.

Example: " :CONF:POW:SMAL ON"
Feature: *RST value: OFF
 SCPI: device-specific
Mode: MS

:CONFigure[:MS]:CHANnel:SFH ON | OFF

This command switches slow-frequency hopping on or off.

Example: " :CONF:CHAN:SFH ON"
Feature: *RST value: OFF
 SCPI: device-specific
Mode: MS

:CONFigure[:MS]:CHANnel:TSC 0 to 7

This command selects the midamble used by the mobile.

Parameter: 0 to 7 (training sequence for the Normal Burst)
Example: " :CONF:CHAN:TSC 3"
Features: *RST value: 0
 SCPI: device-specific
Mode: MS

:CONFigure[:MS]:NETWork[:TYPE] PGSM | PGSM900 | EGSM |EGSM900 | DCS |GSM1800 | PCS|GSM1900 | RGSM | RGSM900 | GSM850

This command selects the standard type according to which the mobile will work.

Example: " :CONF:NETW DCS "

Features: *RST value: GSM
SCPI: device-specific

Mode: MS

:CONFigure[:MS]:NETWork:PHASe 1 | 2 [,PLUS]

This command selects the phase of the standard according to which the mobile will work.

Example: " :CONF:NETW:PHAS 2 "

Features: *RST value: 1
SCPI: device-specific

Mode: MS

:CONFigure[:MS]:TXSupp ON | OFF

This command defines that an additional carrier suppression of min. 20dB is taken into account for the measurement. If there is already suppression, a more sensitive setting of the instrument is selected.

Example: " :CONF:TXS ON "

Features: *RST value: OFF
SCPI: device-specific

Mode: MS

For measurements in the RX-band the value is automatically set to ON.

:CONFigure[:MS]:PRESet

This command resets the parameters for the standard selected to their default values (DEFAULT SETTINGS).

Example: " :CONF:PRES "

Features: *RST value: --
SCPI: device-specific

Mode: MS

This command is an event and has thus no query and no *RST value assigned.

:CONFigure[:MS]:SWEeptime STANdard | AUTO

This command selects the sweep-time computing mode for the spurious measurement:

Example: " :CONF:SWE AUTO "

Feature: *RST value: STANdard
 SCPI: device-specific

Mode: MS

STANdard The computation of the sweep time is based on a worst-case estimation

AUTO The sweep time is reduced by a factor of 8 (assuming all slots are on).

:CONFigure[:MS]:MTYPe GMSK | EDGE

This command selects the standard (GMSK or EDGE).

Example: " :CONF:MTYP EDGE "

Features: *RST value: GMSK
 SCPI: device-specific

Mode: MS

CONFigure:SPECTrum Subsystem

This subsystem provides the commands for configuring the measurements in the GSM BTS Analyzer mode (FSE-K11) or in the GSM MS Analyzer mode (FSE-K10) used to determine the power of the spectral contributions due to modulation and switching (modulation spectrum, transient spectrum).

| COMMAND | PARAMETERS | UNIT | COMMENT |
|--------------|---|------|-------------------------------------|
| CONFigure | | | |
| :SPECTrum | | | |
| :MODulation | | | |
| [:IMMEDIATE] | -- | -- | no query, Option FSE-K11 or FSE-K10 |
| :COUNT | <numeric_value> | -- | Option FSE-K11 or FSE-K10 |
| :RANGE | ARFCn TXBand RXBand COMBined DCSRx1800 G8Rxband PCSRx1900 | | Option FSE-K11 or FSE-K10 |
| :TGATe | <Boolean> | | Option FSE-K11 |
| :SWITChing | | -- | Option FSE-K11 or FSE-K10 |
| [:IMMEDIATE] | -- | -- | no query |
| :COUNT | <numeric_value> | | |

:CONFigure:SPECTrum:MODulation[:IMMEDIATE]

This command selects measurement of the spectrum due to modulation.

Example: " : CONF : SPEC : MOD "

Features: *RST value: --
SCPI: device-specific

Modes: BTS, MS

This command is an event and has thus no query and no *RST value assigned.

:CONFigure:SPECTrum:MODulation:COUNT 1 to 1000

This command sets the number of bursts used for determining the average and maximum values.

Example: " : CONF : SPEC : MOD : COUN 100 "

Features: *RST value: 500 (GSM/DCS1800 phase I)
200 otherwise
SCPI: device-specific

Modes: BTS, MS

:CONFigure:SPECtrum:MODulation:RANGe ARFCn | TXBand | RXBand | COMBined | DCSRx1800 | G8Rxband | PCSRx1900

This command selects the frequency range for the measurement.

Example: " :CONF:SPEC:MOD:RANG TXB "

Features: *RST value: ARFCn
 SCPI: device-specific

Modes: BTS, MS

ARFCn ARFCN ± 1.8 MHz
 TXBand TX-Band
 RXBand RX-Band
 COMBined ARFCN ± 1.8 MHz / TX-Band
 DCSRx1800 RX band DCS 1800 (option FSE-K10 only)
 G8Rxband RX band GSM 850 (option FSE-K10 only)
 PCSRx1900 RX band PCS 1900 (option FSE-K10 only)

:CONFigure:SPECtrum:MODulation:TGATe ON | OFF

This command switches on or off the operating mode gating for the TX band. For TGATe OFF, 8 active slots are presumed.

Example: " :CONF:SPEC:MOD:TGAT ON "

Features: *RST value: OFF
 SCPI: device-specific

Mode: BTS

:CONFigure:SPECtrum:SWITching[:IMMediate]

This command selects measurement of the spectrum due to switching transients.

Example: " :CONF:SPEC:SWIT "

Features: *RST value: --
 SCPI: device-specific

Modes: BTS, MS

This command is an event and has thus no query and no *RST value assigned.

:CONFigure:SPECtrum:SWITching:COUNT 1 to 1000

This command defines the number of bursts used for determining the average and maximum values.

Example: " :CONF:SPEC:SWIT:COUN 100 "

Features: *RST value: 500 (GSM/DCS1800 phase I)
 200 otherwise
 SCPI: device-specific

Modes: BTS, MS

CONFigure:SPURious Subsystem

This subsystem provides commands for configuring the measurements in the GSM BTS (FSE-K11) or GSM MS (FSE-K10) Analyzer mode used for measuring the power of spurious emissions.

| COMMAND | PARAMETERS | UNIT | COMMENT |
|--------------|--|------|-----------------------------------|
| CONFigure | | | |
| :SPURious | | | |
| [:IMMediate] | -- | -- | no query, Option FSE-K11, FSE-K10 |
| :COUNt | <numeric_value> | -- | Option FSE-K11, FSE-K10 |
| :RXBand | <numeric_value> | -- | Option FSE-K11 |
| :RANGe | TXBand OTXBand RXBand IDLeband COMBined | -- | Option FSE-K11, FSE-K10 |
| :STEP<1..26> | <Boolean> | -- | Option FSE-K11, FSE-K10 |
| :COUNt? | | | query only |
| :ANTenna | CONDUCTed RADiated | | Option FSE-K10 |

:CONFigure:SPURious[:IMMediate]

This command selects measurement of spurious emissions.

Example: " :CONF:SPUR "

Features: *RST value: --
SCPI: device-specific

Modes: BTS, MS

This command is an event and has thus no query and no *RST value assigned.

:CONFigure:SPURious:COUNt 1 to 1000

This command sets the number of bursts used for determining the average and maximum values.

Example: " :CONF:SPUR:COUN 100 "

Features: *RST value: 500 (GSM/DCS1800 phase I)
200 otherwise
SCPI: device-specific

Modes: BTS, MS

The number of bursts in measurements of the RX band is set by command
:CONFigure:SPURious:RANGe:RXBand (FSE K11 only).

:CONFigure:SPURious:COUNt:RXBand 1 to 1000

This command sets the number of bursts used for determining the average and maximum values in measurements of the RX band.

Example: " :CONF:SPUR:COUN:RXB 100 "

Features: *RST value: 1
SCPI: device-specific

Modes: BTS

:CONFigure:SPURious:RANGe TXBand | OTXBand | RXBand | IDLeband | COMBined

This command selects the frequency range used for the measurement.

Example: " :CONF:SPUR:RANG OTX "

Features: *RST value: TXB
SCPI: device-specific

Modes: BTS, MS

TXBand TX-Band
OTXBand Not TX-Band
RXBand RX-Band (option FSE-K11 only)
IDLeband Idle band (option FSE-K10 only)
COMBined TX-Band ± 2 MHz (option FSE-K11 only)

:CONFigure:SPURious:STEP<1 to 26> ON | OFF

This command selects a subband of the selected band for a spurious measurement.

Each band is divided up into 1 to max. 26 subbands, which are selected by the numerical suffix following STEP. A subband is selected for measurement by setting ON.

Example: " :CONF:SPUR:STEP24 ON "

Feature: *RST value: ON
SCPI: device-specific

Mode: BTS, MS

:CONFigure:SPURious:STEP:COUNT?

This command queries the number of subbands of the currently selected band for a spurious measurement.

Example: " :CONF:SPUR:STEP:COUNT? "

Feature: *RST value: -
SCPI: device-specific

Mode: BTS, MS

This command is a query and has therefore no *RST value assigned.

:CONFigure:SPURious:ANTenna CONDucted | RADiated

This command selects the features of the measurement of spurious emissions.

Example: " :CONF:SPUR:ANT RAD "

Feature: *RST value: COND
SCPI: device-specific

Mode: MS

DIAGnostic Subsystem

The DIAGnostic subsystem contains the commands which support instrument diagnostics for maintenance, service and repair. In accordance with the SCPI standard, all of these commands are device-specific.

| COMMAND | PARAMETERS | UNIT | COMMENT |
|---|---------------------------------|------|------------|
| DIAGnostic :SERvice :INPut [:SElect] | CALibration RF | -- | |
| :FUNction | <numeric_value>,>numeric_value> | -- | no query |
| :NSource | <Boolean> | -- | |
| :INFO :CCOunt :ATTenuation<1 2 3>? | | | query only |

:DIAGnostic:SERvice:INPut[:SElect] CALibration | RF

This command toggles between the RF input on the front panel and the internal 120-MHz reference signal.

Example: " :DIAG:SERV:INP CAL "

Features: *RST value: RF
SCPI: device-specific

Modes: A, VA

:DIAGnostic:SERvice:FUNction <numeric_value>,<numeric_value>...

This command activates a service function.

Example: " :DIAG:SERV:FUNC 2,0,2,12,1 "

Features: *RST value: -
SCPI: device-specific

Modes: A, VA

The service function is selected via five parameters: functional group number, board number, function number, parameter 1 and parameter 2 (see service manual).

:DIAGnostic:SERvice:NSource ON | OFF

This command switches the 28-V supply at the rear connector of the noise source on and off.

Example: " :DIAG:SERV:NSO ON "

Features: *RST value: OFF
SCPI: device-specific

Modes: A, VA

:DIAGnostic:INFO:CCOunt:ATTenuation<1 | 2 | 3>?

This command queries the cycle counters of the attenuators. The suffix selects the attenuator:

1: Basic instrument 2: Tracking Generator 3: FSE-B13

The result is output as a list of values separated by a ','. The list starts with the date.

Example: " :DIAG:INFO:CCO:ATT? "

Features: *RST value: --
 SCPI: device-specific

Modes: A, VA, MS, BTS

This command is a query and has therefore no *RST value assigned.

DISPlay Subsystem

The DISPlay subsystem controls the selection and presentation of textual and graphic information as well as of trace data on the display.

The displays in the split-screen mode are assigned to WINDOW 1 (screen A) or 2 (screen B) .

| COMMAND | PARAMETERS | UNIT | COMMENT |
|----------------|--|-----------------------|---|
| DISPlay | | | |
| :FORMat | SINGle SPLit | | |
| :PROgram | | | |
| [:MODE] | <Boolean> | | Controller option |
| :ANNotation | | | |
| :FREQuency | <Boolean> | | |
| :LOGO | <Boolean> | | |
| :CMAP<1 to 13> | | | |
| :DEFault | | | |
| :HSL | 0 to 100,0 to 100,0 to 100 | | |
| :PDEFined | BLACK BLUE BROWN GREEN CYAN RED MAGenta YELLOW WHITE DGRAY LGRAY LBLue LGreen LCYan LRED LMAGenta | | |
| [:WINDow<1 2>] | | | |
| :SElect | | | |
| :TEXT | | | |
| [:DATA] | <string> | | |
| :STATe | <Boolean> | | |
| :TIME | <Boolean> | | |
| :MINFo | <Boolean> | | |
| :TRACe<1 to 4> | | | |
| :X | | | |
| [:SCALE] | | | Vector Signal Analysis |
| :RVALue | <numeric_value> | | |
| :ZOOM | <Boolean> | | |
| [:FREQuency] | | | |
| :START | <numeric_value> | HZ | |
| :STOP | <numeric_value> | HZ | |
| :CENTer | <numeric_value> | HZ | |
| :Y | | | |
| [:SCALE] | <numeric_value> | DB | |
| :MODE | ABSolute RELative | | |
| :RLEVel | <numeric_value> | DBM | |
| :OFFSet | <numeric_value> | DB | |
| :RVALue | <numeric_value> | DBM DB HZ DEG RAD | |
| :AUTO | <Boolean> | | Analyzer mode only |
| :RPOSition | <numeric_value> | PCT | Vector Signal Analysis or Tracking Generator |
| :PDIVision | <numeric_value> | DBM DB HZ DEG RAD | Vector Signal Analysis |
| :SPACing | LINear LOGarithmic PERCent | -- | |

| COMMAND | PARAMETERS | UNIT | COMMENT |
|--|---|-----------------------------------|--|
| [[:WINDow<1 2>] :TRACe<1 to 4> :MODE :CWRite :ANALog :HCONtinuous [:STATe] :SYMBol :EYE :COUNT :PSAVe [:STATe] HOLDoff | WRITe VIEW AVERAge MAXHold MINHold <Boolean> <Boolean> <Boolean> <Boolean> DOTS BARS OFF <numeric_value> <Boolean> <numeric_value> | -- -- -- -- -- SYM | Vector Signal Analysis Vector Signal Analysis Vector Signal Analysis |

:DISPlay:FORMat SINGLE | SPLit

This command switches the test result display between FULL SCREEN and SPLIT SCREEN.

- Example:** " :DISP:FORM SPL "
- Features:** *RST value: SINGLE
SCPI: device-specific
- Modes:** A, VA

:DISPlay:PROGram[:MODE] ON | OFF

This command switches the display between the measuring instrument and the computer function.

- Example:** " :DISP:PROG ON "
- Features:** *RST value: OFF
SCPI: device-specific
- Modes:** A, VA, BTS, MS

This command is only valid in conjunction with Option Computer Function (FSE-B15).

:DISPlay:ANNotation:FREQuency ON | OFF

This command switches the x-axis annotation on or off.

- Example:** " :DISP:ANN:FREQ OFF "
- Features:** *RST value: ON
SCPI: conforming
- Modes:** A, VA, BTS, MS

:DISPlay:LOGO ON | OFF

This command switches the factory logo on the screen on or off.

- Example:** " :DISP:LOGO OFF "
- Features:** *RST value: ON
SCPI: device-specific
- Modes:** A, VA, BTS, MS

:DISPlay:CMAP<1 to 13>:DEFault

This command resets the screen colors of the instrument to their default settings.

Example: " :DISP:CMAP:DEF "

Features: *RST value: --
SCPI: conforming

Modes: A, VA, BTS, MS

This command is an event and has thus no query and no *RST value assigned. The numeric suffix in CMAP<1 to 13> is not significant.

:DISPlay:CMAP<1 to 13>:HSL <hue>,<sat>,<lum>

This command defines the color table of the instrument.

Parameter: hue = TINT
sat = SATURATION
lum = BRIGHTNESS

The value range is 0.0 to 100.0 for all parameters.

Example: " :DISP:CMAP2:HSL 0.3,0.8,1.0 "

Features: *RST value: --
SCPI: conforming

Modes: A, VA, BTS, MS

To each numeric suffix of CMAP is assigned one or several picture elements which can be modified by varying the corresponding color setting. The following assignment applies:

| | | | |
|-------|------------------|--------|---------------------------|
| CMAP1 | Trace 1 | CMAP8 | Soft key State Data Entry |
| CMAP2 | Trace 2 | CMAP9 | Soft key State OFF |
| CMAP3 | Trace 3 | CMAP10 | Soft key Shade |
| CMAP4 | Trace 4 | CMAP11 | Text |
| CMAP5 | Marker | CMAP12 | Title |
| CMAP6 | Grid | CMAP13 | Background |
| CMAP7 | softkey State On | | |

The values set are not changed by *RST.

:DISPlay:CMAP<1 to 13>:PDEFined BLACK | BLUE | BROWn | GREen | CYAN | RED | MAGenta |
 YELLow | WHITE | DGRay | LGRay | LBLue | LGReen |
 LCYan | LRED | LMAGenta

This command defines the color table of the instrument using predefined color values. To each numeric suffix of CMAP is assigned one or several picture elements which can be modified by varying the corresponding color setting. The same assignment as for :DISPlay:CMAP<1 to 13>:HSL applies.

Example: " :DISP:CMAP2:PDEF GRE "

Features: *RST value: --
SCPI: conforming

Modes: A, VA, BTS, MS

The values set are not changed by *RST.

:DISPlay[:WINDow<1|2>]:SElect

This command selects the active measurement window via the numeric suffix in WINDow . This way, a switch is possible from FULL SCREEN A to FULL SCREEN B (see example).

Example: ":DISP:FORM SPLit"
 ":DISP:WIND2:SEL"
 ":DISP:FORM SINGLe"

Features: *RST value: --
 SCPI: device-specific

Modes: A, VA

This command is an event and has thus no query and no *RST value assigned.

:DISPlay[:WINDow<1|2>]:MINFo ON | OFF

This command switches the marker info list on the screen on or off.

Example: ":DISP:MINF ON"

Features: *RST value: OFF
 SCPI: device-specific

Modes: A, VA, BTS, MS

:DISPlay[:WINDow<1|2>]:TEXT[:DATA] <string>

This command defines a comment (max. 50 characters) which can be displayed on the screen.

Example: ":DISP:TEXT "signal/noise power measurement"

Features: *RST value: "" (empty)
 SCPI: conforming

Modes: A, VA, BTS, MS

The numeric suffix in WINDow<1|2> is not significant.

:DISPlay[:WINDow<1|2>]:TEXT:STATe ON | OFF

This command switches on or off the screen display of the comment.

Example: ":DISP:TEXT:STAT ON"

Features: *RST value: OFF
 SCPI: conforming

Modes: A, VA, BTS, MS

The numeric suffix in WINDow<1|2> is not significant.

:DISPlay[:WINDow<1|2>]:TIME ON | OFF

This command switches on or off the screen display of date and time.

Example: " :DISP:TIME ON"

Features: *RST value: OFF
SCPI: device-specific

Modes: A, VA, BTS, MS

The numeric suffix in WINDow<1|2> is not significant.

:DISPlay[:WINDow<1|2>]:TRACe<1 to 4>:X[:SCALe]:RVALue <numeric_value>

This command defines the reference value for the X-axis of the measuring diagram.

Example: " :DISP:TRAC:X:RVAL 20SYM"

Features: *RST value: -
SCPI: device-specific

Mode: VA-D

:DISPlay[:WINDow<1|2>]:TRACe<1 to 4>:X[:SCALe]:ZOOM ON | OFF

This command displays the zoomed current frequency range in the opposite window of the split screen representation.

Example: " :DISP:TRAC:X:ZOOM ON"

Features: *RST value: OFF
SCPI: device-specific

Mode: A-F

The numeric suffix in TRACe<1 to 4> is not significant.

:DISPlay[:WINDow<1|2>]:TRACe<1 to 4>:X[:SCALe]:ZOOM[:FREQuency]:START <numeric_value>

This command defines the start frequency of the zoomed display range. The value must lie between start and stop frequency of the original range.

Example: " :DISP:TRAC:X:ZOOM:STAR 100MHZ "

Features: *RST value: -- (depending on the current frequency setting)
SCPI: device-specific

Mode: A-F

The numeric suffix in TRACe<1 to 4> is not significant.

:DISPlay[:WINDow<1|2>]:TRACe<1 to 4>:X[:SCALe]:ZOOM[:FREQuency]:STOP <numeric_value>

This command defines the stop frequency of the zoomed display range. The value must lie between start and stop frequency of the original range.

Example: " :DISP:TRAC:X:ZOOM:STOP 200MHZ "

Features: *RST value: -- (depending on the current frequency setting)
SCPI: device-specific

Mode: A-F

The numeric suffix in TRACe<1 to 4> is not significant.

:DISPlay[:WINDow<1|2>]:TRACe<1 to 4>:X[:SCALe]:ZOOM[:FREQUency]:CENTer
 <numeric_value>

This command shifts the zoomed frequency range to the specified center frequency.

Example: " :DISP:TRAC:X:ZOOM:CENT 1GHZ "

Features: *RST value: -- (depending on the current frequency setting)
 SCPI: device-specific

Mode: A-F

The numeric suffix in TRACe<1 to 4> is not significant.

:DISPlay[:WINDow<1|2>]:TRACe<1 to 4>:Y[:SCALe] 10dB to 200dB

This command defines the display range of the Y-axis (level axis) with logarithmic scaling (DISP:TRAC:Y:SPAC LOG).

Example: " :DISP:TRAC:Y 110dB "

Features: *RST value: 100dB
 SCPI: device-specific

Mode: A

For linear scaling, (DISP:TRAC:Y:SPAC LIN | PERC) the display range is fixed and cannot be set. The numeric suffix in TRACe<1 to 4> is not significant.

:DISPlay[:WINDow<1|2>]:TRACe<1 to 4>:Y[:SCALe]:MODE ABSolute | RELative

This command defines the scale of the y-axis (absolute or relative).

Example: " :DISP:TRAC:Y:MODE REL "

Features: *RST value: ABS
 SCPI: device-specific

Mode: A

As long as SYSTem:DISPlay is set to OFF, this command does not directly influence the screen. The numeric suffix in TRACe<1 to 4> is not significant.

:DISPlay[:WINDow<1|2>]:TRACe<1 to 4>:Y[:SCALe]:RLEVel -200dBm to 200dBm

This command defines the reference level.

Example: " :DISP:TRAC:Y:RLEV -60dBm "

Features: *RST value: -20dBm
 SCPI: conforming

Modes: A, VA

The numeric suffix in TRACe<1 to 4> is not significant.

:DISPlay[:WINDow<1|2>]:TRACe<1 to 4>:Y[:SCALe]:RLEVel:OFFSet -200dB to 200dB

This command defines the offset of the reference level.

Example: " :DISP:TRAC:Y:RLEV:OFFS -10dB "

Features: *RST value: 0dB
SCPI: conforming

Modes: A, VA

The numeric suffix in TRACe<1 to 4> is not significant.

:DISPlay[:WINDow<1|2>]:TRACe<1 to 4>:Y[:SCALe]:RVALue <numeric_value>

This command defines the reference value for the y-axis of the measurement diagram.

This defines the upper limit of the display range, the corresponding parameters of the manual control vary according to the measurement mode.

In the spectrum analysis mode the setting corresponds to the parameter MAX LEVEL.

In the vector signal analysis mode the setting corresponds to the parameter REFERENCE VALUE Y AXIS.

IF option tracking generator is fitted and the normalization in the analyzer mode is activated, the value corresponds to the parameter REFERENCE VALUE.

Example: " :DISP:TRAC:Y:RVAL -20dBm" (spectrum analysis)
" :DISP:TRAC:Y:RVAL +1.20" (vector signal analysis)
" :DISP:TRAC:Y:RVAL 0" (tracking generator)

Features: *RST value: - coupled to reference level
0 (vector signal analysis)
0 dB (tracking generator with active normalization)
SCPI: device specific

Modes: A, VA

The numeric suffix in TRACe<1 to 4> is not significant.

:DISPlay[:WINDow<1|2>]:TRACe<1 to 4>:Y[:SCALe]:RVALue:AUTO ON | OFF

This command defines whether the reference value for the y-axis of the measured diagram is coupled to the reference level (default) or can be set independently.

Example: " :DISP:TRAC:Y:RVAL:AUTO ON "

Features: *RST value: ON
SCPI: device-specific

Mode: A

This command is available in the analyzer mode only. The numeric suffix in TRACe<1 to 4> is not significant.

:DISPlay[:WINDow<1|2>]:TRACe<1 to 4>:Y[:SCALe]:RPOsition 0 to 100PCT

This command defines the position of the reference value.

Example: " :DISP:TRAC:Y:RPOS 50PCT "

Features: *RST value: 100PCT (tracking generator)
50PCT (vector analyzer)
SCPI: conforming

Modes: A, VA

The numeric suffix in TRACe<1 to 4> is not significant. This command is only valid in conjunction with option Tracking Generator or in vector analyzer mode.

:DISPlay[:WINDow<1|2>]:TRACe<1 to 4>:Y[:SCALe]:PDIVision <numeric_value>

This command defines the scaling of the Y-axis in the current unit.

Example: " :DISP:TRAC:Y:PDIV +1.20 "

Features: *RST value: -
SCPI: conforming

Mode: VA

The numeric suffix in TRACe<1 to 4> is not significant.

:DISPlay[:WINDow<1|2>]:TRACe<1 to 4>:Y:SPACing LINear | LOGarithmic | PERCent

This command toggles between linear and logarithmic display.

Example: " :DISP:TRAC:Y:SPAC LIN "

Features: *RST value: LOGarithmic
SCPI: conforming

Mode: A

The linear display can be LIN/% (PERCent) or LIN/dB (LINear). The numeric suffix in TRACe<1 to 4> is not significant.

:DISPlay[:WINDow<1|2>]:TRACe<1 to 4>:MODE WRITe | VIEW | AVERAge | MAXHold | MINHold

This command defines the type of display and the evaluation of the traces.

Example: " :DISP:TRAC3:MODE MAXH "

Features: *RST value: WRITe for TRACe1, STATe OFF for TRACe2 to 4
SCPI: device-specific

Modes: A, VA, BTS, MS

:DISPlay[:WINDow<1|2>]:TRACe<1 to 4>:MODE:CWRite ON | OFF

This command selects continuous display of the measured values (continuous write).

Example: " :DISP:TRAC3:MODE:CWR ON "

Features: *RST value: OFF
SCPI: device-specific

Mode: VA

:DISPlay[:WINDow<1|2>]:TRACe<1 to 4>:MODE:ANALog ON | OFF

This command selects continuous display of the measured values in the analyzer mode (analog trace).

Example: " :DISP:TRAC3:MODE:ANAL ON "

Features: *RST value: OFF
SCPI: device-specific

Mode: A

:DISPlay[:WINDow<1|2>]:TRACe<1 to 4>:MODE:HCONtinuous ON | OFF

This command defines whether the traces in the min hold/max hold mode are reset after some definite parameter changes.

Example: " :DISP:TRAC3:MODE:HCON ON "

Features: *RST value: OFF
SCPI: device-specific

Mode: A

OFF The traces are reset after some definite parameter changes.

ON This mechanism is switched off.

In general, parameter changes require a restart of the measurement before results are evaluated (e.g. with markers). For those changes that are known to require a new measurement (e.g. modification of the span), the trace is automatically reset so that erroneous evaluations of previous results are avoided. This mechanism can be switched off for those exceptional cases where the described behavior is unwelcome.

The numeric suffix in WINDow<1|2> is not significant.

:DISPlay[:WINDow<1|2>]:TRACe<1 to 4>[:STATe] ON | OFF

This command switches the display of the corresponding trace on or off.

Example: " :DISP:TRAC3 ON "

Features: *RST value: ON for TRACe1, OFF for TRACe2 to 4
SCPI: conforming

Modes: A, VA, BTS, MS

:DISPlay[:WINDow<1|2>]:TRACe<1 to 4>:SYMBol DOTS | BARS | OFF

This command determines the display of the points of decision on the trace.

Example: " :DISP:TRAC:SYMB BARS "

Features: *RST value: OFF
SCPI: device-specific

Mode: VA-D

:DISPlay[:WINDow<1|2>]:TRACe<1 to 4>:EYE:COUNT 1 to Result Length

This command determines the display range of the eye diagram in symbols.

Example: " :DISP:TRAC:EYE:COUNT 5 "

Features: *RST value: 2
SCPI: device-specific

Mode: VA-D

:DISPlay:PSAVe[:STATe] ON | OFF

This command switches the screen saver mode on or off.

Example " :DISP:PSAV ON "

Features: *RST value: OFF
SCPI: device-specific

Modes: A, VA, BTS, MS

:DISPlay:PSAVe:HOLDoff <numeric_value>

This command determines the time after which the screen saver is switched on. Values are input in minutes, the valid range is 1 to 100 minutes.

Example: " :DISP:PSAV:HOLD 10 "

Features: *RST value: 1
SCPI: device-specific

Modes: A, VA, BTS, MS

FETCh Subsystem

The FETCh subsystem contains commands for reading out results of complex measurement tasks like those provided by options GSM BTS Analyzer, FSE-K11, or GSM MS Analyzer, FSE-K10. The FETCh-subsystem is closely linked to the functions of the CONFigure and READ-subsystems, where the measurement sequences are configured, the measurements are started and their results are queried.

FETCh:BURSt Subsystem

This subsystem provides the commands for reading out results of measurements in the GSM BTS (option FSE-K11) or GSM MS (option FSE-K10) Analyzer mode, which are performed on individual bursts (Carrier Power, Phase/Frequency Error) without starting the measurement by themselves.

| COMMAND | PARAMETERS | UNIT | COMMENT |
|---------------|------------|------|---------------------------|
| FETCh | | | Option FSE-K11 or FSE-K10 |
| :BURSt | | | |
| :PERRor | | | |
| :RMS | | | |
| :STATus? | | | query only |
| :AVERAge? | -- | | query only |
| :MAXimum? | -- | | query only |
| :PEAK | | | |
| :STATus? | | | query only |
| :AVERAge? | -- | | query only |
| :MAXimum? | -- | | query only |
| :FERRor | | | |
| :STATus? | | | query only |
| :AVERAge? | -- | | query only |
| :MAXimum? | -- | | query only |
| :POWer | -- | | |
| [:IMMEdiate]? | -- | | query only |
| :ALL? | -- | | query only |
| :MACCuracy | | | |
| :RMS | | | |
| :STATus? | | | query only |
| :AVERAge? | -- | | query only |
| :MAXimum? | -- | | query only |
| :PEAK | | | |
| :STATus? | | | query only |
| :AVERAge? | -- | | query only |
| :MAXimum? | -- | | query only |
| :OSUPpress | | | |
| :STATus? | | | query only |
| :AVERAge? | -- | | query only |
| :MAXimum? | -- | | query only |
| :PERCentile | | | |
| :STATus? | | | query only |
| :AVERAge? | -- | | query only |
| :MAXimum? | -- | | query only |
| :FREQuency | | | |
| :STATus? | | | query only |
| :AVERAge? | -- | | query only |
| :MAXimum? | -- | | query only |

:FETCh:BURSt:PERRor:RMS:STATus?

This command reads out the status of the RMS-measurement of the phase error taken over the selected number of bursts.

0: failed, 1: passed

Example: " :FETC: BURS: PERR: RMS: STAT? "

Features: *RST value: --
SCPI: device-specific

Modes: BTS, MS

If no measurement has been performed yet, a query error results.
This command is a query and has therefore no *RST value assigned.
It is available only when measurement of the phase/frequency error is selected (see :CONFigure: BURSt: PFERror).

:FETCh:BURSt:PERRor:RMS:AVERAge?

This command reads out the average of the RMS-measurement of the phase error taken over the selected number of bursts.

Example: " :FETC: BURS: PERR: RMS: AVER? "

Features: *RST value: --
SCPI: device-specific

Modes: BTS, MS

If no measurement has been performed yet, a query error results.
This command is a query and has therefore no *RST value assigned.
It is available only when measurement of the phase/frequency error is selected (see :CONFigure: BURSt: PFERror).

:FETCh:BURSt:PERRor:RMS:MAXimum?

This command reads out the maximum of the RMS-measurement of the phase error for the selected number of bursts.

Example: " :FETC: BURS: PERR: RMS: MAX? "

Features: *RST value: --
SCPI: device-specific

Modes: BTS, MS

If no measurement has been performed yet, a query error results.
This command is a query only and therefore has no *RST value assigned. It is available only when measurement of the phase/frequency error is selected (see :CONFigure: BURSt: PFERror).

:FETCh:BURSt:PERRor:PEAK:STATus?

This command reads out the status of the peak measurement of the phase error taken over the selected number of bursts.

0: failed, 1: passed

Example: " :FETC:BURS:PERR:PEAK:STAT? "

Features: *RST value: --
SCPI: device-specific

Modes: BTS, MS

If no measurement has been performed yet, a query error results.

This command is a query only and therefore has no *RST value assigned. It is available only if measurement of the phase/frequency error is selected (see :CONFIgure:BURSt:PFERror).

:FETCh:BURSt:PERRor:PEAK:AVERage?

This command reads out the average of the peak measurement of the phase error taken over the selected number of bursts.

Example: " :FETC:BURS:PERR:PEAK:AVER? "

Features: *RST value: --
SCPI: device-specific

Modes: BTS, MS

If no measurement has been performed yet, a query error results.

This command is a query only and therefore has no *RST value assigned. It is available only if measurement of the phase/frequency error is selected (see :CONFIgure:BURSt:PFERror).

:FETCh:BURSt:PERRor:PEAK:MAXimum?

This command reads out the maximum of the peak measurement of the phase error for the selected number of bursts.

Example: " :FETC:BURS:PERR:PEAK:MAX? "

Features: *RST value: --
SCPI: device-specific

Modes: BTS, MS

If no measurement has been performed yet, a query error results.

This command is a query only and therefore has no *RST value assigned. It is available only when measurement of the phase/frequency error is selected (see :CONFIgure:BURSt:PFERror).

:FETCh:BURSt:FERRor:STATus?

This command reads out the status of the measurement of the frequency error taken over the selected number of bursts.

0: failed, 1: passed

Example: " :FETC:BURS:FERR:STAT? "

Features: *RST value: --
SCPI: device specific

Modes: BTS, MS

If no measurement has been performed yet, a query error results.

This command is a query only and therefore has no *RST value assigned. It is available only if measurement of the phase/frequency error is selected (see :CONFIgure:BURSt:PFERRor).

:FETCh:BURSt:FERRor:AVERage?

This command reads out the average of the measurement of the frequency error taken over the selected number of bursts.

Example: " :FETC:BURS:FERR:AVER? "

Features: *RST value: --
SCPI: device-specific

Modes: BTS, MS

If no measurement has been performed yet, a query error results.

This command is a query only and therefore has no *RST value assigned. It is available only if measurement of the phase/frequency error is selected (see :CONFIgure:BURSt:PFERRor).

:FETCh:BURSt:FERRor:MAXimum?

This command reads out the maximum frequency error measured over the selected number of bursts.

Example: " :FETC:BURS:FERR:MAX? "

Features: *RST value: --
SCPI: device-specific

Modes: BTS, MS

If no measurement has been performed yet, a query error results.

This command is a query only and therefore has no *RST value assigned. It is available only if measurement of the phase/frequency error is selected (see :CONFIgure:BURSt:PFERRor).

:FETCh:BURSt:POWer[:IMMediate]?**Carrier Power measurement (:CONFigure:MS:POWer:SINGle:STATe OFF):**

This command reads out the result of the last step performed during the measurement of the output power of the base station or mobile.

Parameter: The result is output as an ASCII string in the following format:

<Static Power Ctrl>,<Dyn Power Ctrl>,<Rat-Level>,<Act-Level>,<Delta>,<Status> with

<Static Power Ctrl>: current static power control level
 <Dyn Power Ctrl>: current dynamic power control level
 <Rat-Level>: Rated value for the current power control level acc. to standard dBm
 <Act-Level>: measured power in dBm
 <Delta>: Difference between the measured power and the power at the previous static/dynamic power control level.
 <Status>: Result of limit check in character data form:
 PASSED no limits exceeded
 FAILED limit exceeded

Example: " :FETC: BURS: POW? "
 Result: 0,0,43,44.1,0,PASSED

Features: *RST value: --
 SCPI: device-specific

Modes: BTS, MS

Carrier Power Individual measurement (:CONFigure:MS:POWer:SINGle:STATe ON)

This command reads out the result of the last step performed during the measurement of the output power of the base station or mobile.

Parameter: The result is output as an ASCII string in the following format:

<Static Power Ctrl>,<Dyn Power Ctrl>,<Rat-Level>,<Act-Level>,<RBW>,<ARFCN>,<CF>,<Attenuation>,<Number of bursts>,<Status>

<Static Power Ctrl>: current static power control level
 <Dyn Power Ctrl>: current dynamic power control level
 <Rat-Level>: Rated value for the current power control level acc. to standard dBm
 <Act-Level>: measured power in dBm
 <RBW>: resolution Bandwidth in kHz
 <ARFCN>: channel number
 <CF>: carrier frequency in Hz
 <Att>: external attenuation in dBm
 <Number of burst>: number of bursts
 <Status>: result of limit check in character data form:
 PASSED no limits exceeded
 FAILED limit exceeded

Example: " :READ: BURS: POW? "
 Result: 0,3,37,20.6915,1000,2,8.904E+008,20,1,FAILED

Features: *RST value: --
 SCPI: device-specific

Modes: BTS, MS

If no measurement has been performed yet, a query error results.

This command is a query only and therefore has no *RST value assigned. It is available only if measurement of the phase/frequency error is selected (see :CONFigure:BURSt:PFError).

:FETCh:BURSt:POWer:ALL?

Carrier Power measurement (:CONFIgure:MS:POWer:SINGle:STATe OFF):

This command reads out the results of all individual steps during the measurement of the output power of the base station or mobile.

Parameter: The result is output as an ASCII string in the following format:

<Static Power Ctrl>,<Dyn Power Ctrl>,<Rat-Level>,<Act-Level>, <Delta>,<Status> with

<Static Power Ctrl>: current static power control level
 <Dyn Power Ctrl>: current dynamic power control level
 <Rat-Level>: Rated value for the current power control level acc. to standard dBm
 <Act-Level>: measured power in dBm
 <Delta>: Difference between the measured power and the power at the previous static/dynamic power control level.
 <Status>: Result of limit check in character data form:
 PASSED no limits exceeded
 FAILED limit exceeded

Example: " :FETC:BURS:POW:ALL? "
 Result: 0,0,43,44.1,0,PASSED,1,0,41,42.5,1.6,PASSED,1,1,35,32.5,5.6,FAILED

Features: *RST value: --
 SCPI: device-specific

Modes: BTS, MS

Carrier Power Individual measurement (:CONFIgure:MS:POWer:SINGle:STATe ON)

This command reads out the results of all individual steps during the measurement of the output power of the base station or mobile.

Parameter: The result is output as an ASCII string in the following format:

<Static Power Ctrl>,<Dyn Power Ctrl>,<Rat-Level>,<Act-Level>,<RBW>,<ARFCN>,<CF>,<Attenuation>,<Number of bursts>,<Status>

<Static Power Ctrl>: current static power control level
 <Dyn Power Ctrl>: current dynamic power control level
 <Rat-Level>: Rated value for the current power control level acc. to standard dBm
 <Act-Level>: measured power in dBm
 <RBW>: resolution Bandwidth in kHz
 <ARFCN>: channel number
 <CF>: carrier frequency in Hz
 <Att>: external attenuation in dBm
 <Number of burst>: number of bursts
 <Status>: result of limit check in character data form:
 PASSED no limits exceeded
 FAILED limit exceeded

Example: " :FETC:BURS:POW:ALL? "
 Result: 0,3,37,20.6915,1000,2,8.904E+008,20,1,FAILED,0,3,37,20.3597,1000,2,8.904E+008,20,1,FAILED

Features: *RST value: --
 SCPI: device-specific

Modes: BTS, MS

If no measurement has been performed yet, a query error results. This command is a query only and therefore has no *RST value assigned. It is available only if measurement of the phase/frequency error is selected (see :CONFIgure:BURSt:PFERror).

:FETCh:BURSt:MACCuracy:RMS:STATus?

This command reads out the status of the RMS measurement of the modulation accuracy taken over the selected number of bursts.

0: failed, 1: passed

Example: " :FETC:BURS:MACC:RMS:STAT? "

Features: *RST value: --
SCPI: device-specific

Modes: BTS, MS

If no measurement has been performed yet, a query error results.

This command is a query only and therefore has no *RST value assigned. It is available only if measurement of the modulation accuracy is selected (see `CONFigure:BURSt:MACCuracy`).

:FETCh:BURSt:MACCuracy:RMS:AVERAge?

This command reads out the average of the RMS measurement of the modulation accuracy taken over the selected number of bursts.

Example: " :FETC:BURS:MACC:RMS:AVER? "

Features: *RST value: --
SCPI: device-specific

Modes: BTS, MS

If no measurement has been performed yet, a query error results.

This command is a query only and therefore has no *RST value assigned. It is available only if measurement of the modulation accuracy is selected (see `CONFigure:BURSt:MACCuracy`).

:FETCh:BURSt:MACCuracy:RMS:MAXimum?

This command reads out the maximum of the RMS measurement of the modulation accuracy taken over the selected number of bursts.

Example: " :FETC:BURS:MACC:RMS:MAX? "

Features: *RST value: --
SCPI: device-specific

Modes: BTS, MS

If no measurement has been performed yet, a query error results.

This command is a query only and therefore has no *RST value assigned. It is available only if measurement of the modulation accuracy is selected (see `CONFigure:BURSt:MACCuracy`).

:FETCh:BURSt:MACCuracy:PEAK:STATus?

This command reads out the status of the PEAK measurement of the modulation accuracy taken over the selected number of bursts.

0: failed, 1: passed

Example: " :FETC:BURS:MACC:PEAK:STAT? "

Features: *RST value: --
SCPI: device-specific

Modes: BTS, MS

If no measurement has been performed yet, a query error results.

This command is a query only and therefore has no *RST value assigned. It is available only if measurement of the modulation accuracy is selected (see `CONFigure:BURSt:MACCuracy`).

:FETCh:BURSt:MACCuracy:PEAK:AVERAge?

This command reads out the average of the PEAK measurement of the modulation accuracy taken over the selected number of bursts.

Example: " :FETC: BURS: MACC: PEAK: AVER? "

Features: *RST value: --
SCPI: device-specific

Modes: BTS, MS

If no measurement has been performed yet, a query error results.

This command is a query only and therefore has no *RST value assigned. It is available only if measurement of the modulation accuracy is selected (see `CONFigure: BURSt: MACCuracy`).

:FETCh:BURSt:MACCuracy:PEAK:MAXimum?

This command reads out the maximum of the PEAK measurement of the modulation accuracy taken over the selected number of bursts.

Example: " :FETC: BURS: MACC: PEAK: MAX? "

Features: *RST value: --
SCPI: device-specific

Modes: BTS, MS

If no measurement has been performed yet, a query error results.

This command is a query only and therefore has no *RST value assigned. It is available only if measurement of the modulation accuracy is selected (see `CONFigure: BURSt: MACCuracy`).

:FETCh:BURSt:MACCuracy:OSUPpress:STATus?

This command reads out the status of the original offset suppression measurement of the modulation accuracy taken over the selected number of bursts.

0: failed, 1: passed

Example: " :FETC: BURS: MACC: OSUP: STAT? "

Features: *RST value: --
SCPI: device-specific

Modes: BTS, MS

If no measurement has been performed yet, a query error results.

This command is a query only and therefore has no *RST value assigned. It is available only if measurement of the modulation accuracy is selected (see `CONFigure: BURSt: MACCuracy`).

:FETCh:BURSt:MACCuracy:OSUPpress:AVERAge?

This command reads out the average of the original offset suppression measurement of the modulation accuracy taken over the selected number of bursts.

Example: " :FETC: BURS: MACC: OSUP: AVER? "

Features: *RST value: --
SCPI: device-specific

Modes: BTS, MS

If no measurement has been performed yet, a query error results.

This command is a query only and therefore has no *RST value assigned. It is available only if measurement of the modulation accuracy is selected (see `CONFigure: BURSt: MACCuracy`).

:FETCh:BURSt:MACCuracy:OSUPpress:MAXimum?

This command reads out the maximum of the original offset suppression measurement of the modulation accuracy taken over the selected number of bursts.

Example: " :FETC: BURS: MACC: OSUP: MAX? "

Features: *RST value: --
SCPI: device-specific

Modes: BTS, MS

If no measurement has been performed yet, a query error results.

This command is a query only and therefore has no *RST value assigned. It is available only if measurement of the modulation accuracy is selected (see `CONFigure: BURSt: MACCuracy`).

:FETCh:BURSt:MACCuracy:PERCentile:STATus?

This command reads out the status of the 95% percentile measurement of the modulation accuracy taken over the selected number of bursts.

0: failed, 1: passed

Example: " :FETC: BURS: MACC: PERC: STAT? "

Features: *RST value: --
SCPI: device-specific

Modes: BTS, MS

If no measurement has been performed yet, a query error results.

This command is a query only and therefore has no *RST value assigned. It is available only if measurement of the modulation accuracy is selected (see `CONFigure: BURSt: MACCuracy`).

:FETCh:BURSt:MACCuracy:PERCentile:AVERage?

This command reads out the average of the 95% percentile measurement of the modulation accuracy taken over the selected number of bursts.

Example: " :FETC: BURS: MACC: PERC: AVER? "

Features: *RST value: --
SCPI: device-specific

Modes: BTS, MS

If no measurement has been performed yet, a query error results.

This command is a query only and therefore has no *RST value assigned. It is available only if measurement of the modulation accuracy is selected (see `CONFigure: BURSt: MACCuracy`).

:FETCh:BURSt:MACCuracy:PERCentile:MAXimum?

This command reads out the maximum of the 95% percentile measurement of the modulation accuracy taken over the selected number of bursts.

Example: " :FETC: BURS: MACC: PERC: MAX? "

Features: *RST value: --
SCPI: device-specific

Modes: BTS, MS

If no measurement has been performed yet, a query error results.

This command is a query only and therefore has no *RST value assigned. It is available only if measurement of the modulation accuracy is selected (see `CONFigure: BURSt: MACCuracy`).

:FETCh:BURSt:MACCuracy:FREQuency:STATus?

This command reads out the status of the frequency error measurement of the modulation accuracy taken over the selected number of bursts.

0: failed, 1: passed

Example: " :FETC:BURS:MACC:FREQ:STAT? "

Features: *RST value: --
SCPI: device-specific

Modes: BTS, MS

If no measurement has been performed yet, a query error results.

This command is a query only and therefore has no *RST value assigned. It is available only if measurement of the modulation accuracy is selected (see `CONFigure:BURSt:MACCuracy`).

:FETCh:BURSt:MACCuracy:FREQuency:AVERage?

This command reads out the average of the frequency error measurement of the modulation accuracy taken over the selected number of bursts.

Example: " :FETC:BURS:MACC:FREQ:AVER? "

Features: *RST value: --
SCPI: device-specific

Modes: BTS, MS

If no measurement has been performed yet, a query error results.

This command is a query only and therefore has no *RST value assigned. It is available only if measurement of the modulation accuracy is selected (see `CONFigure:BURSt:MACCuracy`).

:FETCh:BURSt:MACCuracy:FREQuency:MAXimum?

This command reads out the maximum of the frequency error measurement of the modulation accuracy taken over the selected number of bursts.

Example: " :FETC:BURS:MACC:FREQ:MAX? "

Features: *RST value: --
SCPI: device-specific

Modes: BTS, MS

If no measurement has been performed yet, a query error results.

This command is a query only and therefore has no *RST value assigned. It is available only if measurement of the modulation accuracy is selected (see `CONFigure:BURSt:MACCuracy`).

FETCh:PTEMplate Subsystem

This subsystem provides the commands for reading out results of measurements in the GSM BTS (FSE-K11) or GSM MS (FSE-K10) Analyzer mode which are used to determine the carrier power of , power versus time measurement without first restarting a new measurement.

| Command | Parameter | Unit | Comment |
|------------------------------------|-----------|------|---|
| FETCh :PTEMplate :REFerence? | | | Option FSE-K11, FSE-K10 query only |

:FETCh:PTEMplate:REFerence?

This command reads out the results of the premeasurement

Parameter: The result is output as a list of partial result strings separated by ',' in the following (ASCII) format:

<Level1>,<Level2>,<RBW>

<Level1>: measured level

<Level2>: level corrected by means of the bandwidth

<RBW>: bandwidth

Example: " :FETCh:PTEM:REF? "
Result: 43.2,43.2,1000000

Features: *RST value: --
SCPI: devicespecific

Modes: BTS, MS

If no measurement has been performed yet, a query error results.

This command is a query only and therefore has no *RST value assigned. It is available only if measurement of Power versus Time is selected (see :CONFIgure:BURSt:PTEMplate).

FETCh:SPECtrum Subsystem

This subsystem provides the commands for reading out results of measurements in the GSM BTS (FSE-K11) or GSM MS (FSE-K10) Analyzer mode, used to measure the power of the spectral contributions due to modulation and switching (modulation spectrum, transient spectrum) without first restarting a new measurement.

| COMMAND | PARAMETERS | UNIT | COMMENT |
|-------------|---|------|---------------------------|
| FETCh | | | Option FSE-K11 or FSE-K10 |
| :SPECtrum | | | |
| :MODulation | | | |
| [:ALL]? | ARFCn TXBand RXBand COMBined DCSRx1800 | | query only |
| :REFerence? | | | query only |
| :SWITching | | | |
| [:ALL]? | -- | | query only |
| :REFerence? | | | query only |

:FETCh:SPECtrum:MODulation[:ALL]? ARFCn | TXBand | RXBand | COMBined | DCSRx1800

This command reads out the result of the measurement of the modulation spectrum of the base station or mobile.

Parameter: The result is output as a list of partial result strings separated by ',' in the following (ASCII) format:

<Index>,<Freq1>,<Freq2>,<Level>,<Limit>, <Abs/Rel>,<Status> [,
<Index>,<Freq1>,<Freq2>,<Level>,<Limit>, <Abs/Rel>,<Status>]...

where the parts between '['...' denote a partial result string that can be repeated n times.

<Index>: 0, if the partial result string characterizes a measurement range
current number <>0,
if the partial result string characterizes a single
limit excess.

<Freq1>: Start frequency of the measurement range or
frequency where the limit line is exceeded

<Freq2>: Start frequency of the measurement range or
frequency exceeding the measurement range. The value of
<Freq2> is equal to the value of <Freq1>, if either the
measurement is performed in the time domain or if the
partial result string contains a limit excess.

<Level>: Measured maximum level of the partial range or
measured level at the test point.

<Limit>: Limit in the partial range or at the test point

<Abs/Rel>: ABS <Level> and <Limit> are in absolute units (dBm)
REL <Level> and <Limit> are in relative units (dB)

<Status>: Result of the limit check in character data form:
PASSED no limit exceeded
FAILED limit exceeded
MARGIN margin exceeded
EXC limit excess marked as an exception

The frequencies <Freq1> and <Freq2> are always absolute i. e. not referred to the carrier frequency.

Example: ":FETC:SPEC:MOD? TXB"
Result: 0,890E6,915E6,-87.4,-108.0,ABS,FAILED,
 1,893.2E6,893.2E6,-83.2,-108.0,ABS,FAILED,
 2,895.7E6,895.7E6,-87.4,-108.0,ABS,FAILED

Features: *RST value: --
 SCPI: device-specific

Modes: BTS, MS

ARFCn ARFCN \pm 1.8 MHz
 TXBand TX-Band
 RXBand RX-Band
 COMBined ARFCN \pm 1.8 MHz / TX-Band (option FSE-K11 only)
 DCSRx1800 RX band DCS 1800 (option FSE-K10 only)

If no measurement has been performed yet, a query error results.
 This command is a query only and therefore has no *RST value assigned. It is available only if measurement of the modulation spectrum is selected (see :CONFigure:SPECTrum:MODulation).

:FETCh:SPECTrum:MODulation:REFerence?

This command reads out the result of the premeasurement.

Parameter: The result is output as a list of partial result strings separated by ',' in the following (ASCII) format:

<Level1>,<Level2>,<RBW>
 <Level1>: measured level
 <Level2>: level corrected by means of the bandwidth
 <RBW>: bandwidth

Example: ":FETC:SPEC:MOD:REF?"
Result: 36.2,43.2,30000

Features: *RST value: --
 SCPI: device-specific

Modes: BTS, MS

If no measurement has been performed yet, a query error results.
 This command is a query only and therefore has no *RST value assigned. It is available only if measurement of the modulation spectrum is selected (see :CONFigure:SPECTrum:MODulation).

:FETCh:SPECTrum:SWITching[:ALL]?

This command reads out the result of the measurement of the transient spectrum of the base station or mobile.

Parameter: The result is output as a list of partial result strings separated by ',' as for the command :FETCh:SPECTrum:MODulation[:ALL]?

Example: " :FETC:SPEC:SWIT?"
 Result: 0,833.4E6,833.4E6,37.4,-36.0,ABS,MARGIN,
 1,834.0E6,834.0E6,-35.2,-36.0,ABS,FAILED,
 2,834.6E6,834.6E6,-74.3,-75.0,REL,FAILED
 0,835.0E6,835.0E6,-65,0,-60.0,REL,PASSED

Features: *RST value: --
 SCPI: device-specific

Modes: BTS, MS

If no measurement has been performed yet, a query error results.

This command is a query only and therefore has no *RST value assigned. It is available only if measurement of the transient spectrum is selected (see :CONFigure:SPECTrum:SWITching).

:FETCh:SPECTrum:SWITching:REference?

This command queries the result of the premeasurement

Parameter: The result is output as a list of partial result strings separated by ',' in the following (ASCII) format:

<Level1>,<Level2>,<RBW>
 <Level1>: measured level
 <Level2>: level corrected by means of the bandwidth
 <RBW>: bandwidth

Example: " :FETC:SPEC:SWIT:REF?"
 Result: 43.2,43.2,300000

Features: *RST value --
 SCPI: device specific

Modes: BTS, MS

If no measurement has been performed yet, a query error results.

This command is a query only and therefore has no *RST value assigned. It is available only if measurement of the transient spectrum is selected (see :CONFigure:SPECTrum:SWITching).

FETCh:SPURious Subsystem

This subsystem provides the commands for reading out results of measurements in the GSM BTS (FSE-K11) or GSM MS (FSE-K10) Analyzer mode which are used to determine spurious emissions, without first restarting a new measurement.

| COMMAND | PARAMETERS | UNIT | COMMENT |
|-----------|--------------------------------------|------|---------------------------|
| FETCh | | | Option FSE-K11 or FSE-K10 |
| :SPURious | | | |
| [:ALL]? | TXBand OTXBand RXBand IDLeband | | query only |
| :STEP? | -- | | query only |

:FETCh:SPURious[:ALL]? TXBand | OTXBand | RXBand | IDLeband

This command reads out the results of the measurement of spurious emissions of the base station or mobile which is performed in the LIST mode.

Parameter: The result is output as a list of partial result strings separated by ',' in the following (ASCII) format:

```
<Index>,<Freq1>,<Freq2>,<Level>,<Limit>, <Abs/Rel>,<Status> [,
<Index>,<Freq1>,<Freq2>,<Level>,<Limit>, <Abs/Rel>,<Status>]...
```

where the parts between '['...]' denote a partial result string that can be repeated n times.

<Index>: 0, if the partial result string characterizes a measurement range
current number <>0,
if the partial result string characterizes a single
limit excess.

<Freq1>: Start frequency of the measurement range or
frequency where the limit line is exceeded

<Freq2>: Start frequency of the measurement range or
frequency exceeding the measurement range. The value of
<Freq2> is equal to the value of <Freq1>, if either the
measurement is performed in the time domain or if the
partial result string contains a limit excess.

<Level>: Measured maximum level of the partial range or
measured level at the test point.

<Limit>: Limit in the partial range or at the test point

<Abs/Rel>: ABS <Level> and <Limit> are in absolute units (dBm)
REL <Level> and <Limit> are in absolute units (dBm)

<Status>: Result of the limit check in character data form:
PASSED no limit exceeded
FAILED limit exceeded
MARGIN margin exceeded

Example: ":FETC:SPUR? TXB"
Result: 0,890E6,915E6,-87.4,-108.0,ABS,FAILED,
 1,893.2E6,893.2E6,-83.2,-108.0,ABS,FAILED,
 2,895.7E6,895.7E6,-87.4,-108.0,ABS,FAILED

Features: *RST value: --
 SCPI: device-specific

Modes: BTS, MS

TXBand TX-band
 OTXBand Not TX-band
 RXBand RX-band (option FSE-K11 only)
 IDLeband Idle band (option FSE-K10 only)

If no measurement has been performed yet, a query error results.

This command is a query only and therefore has no *RST value assigned. It is available only if measurement of the spurious emissions is selected (see :CONFigure:SPURious).

:FETCh:SPURious:STEP?

This command reads out the result of the last single step of the measurement of spurious emissions performed in the STEP mode.

Parameter: The result is output as a list of partial result strings separated by ',' as for the command :FETCh:SPURious[:ALL]?.

Example: ":FETC:SPUR:STEP?"
Result: 0,890E6,915E6,-87.4,-108.0,ABS,FAILED,
 1,893.2E6,893.2E6,-83.2,-108.0,ABS,FAILED,
 2,895.7E6,895.7E6,-87.4,-108.0,ABS,FAILED

Features: *RST value: --
 SCPI: device-specific

Modes: BTS, MS

If no measurement has been performed yet, a query error results.

This command is a query only and therefore has no *RST value assigned. It is available only if measurement of the spurious emissions is selected (see :CONFigure:SPURious).

:FORMat:DEXPort:DSEParator POINT|COMMa

This command determines the decimal separator (decimal point or comma) for the output of the measurement data in ASCII format. Thus, evaluation programmes (i.e. MS-Excel) of different language versions are supported.

Example: ":FORM:DEXP:DSEP POIN
Features: *RST value: POINT
 SCPI: device specific
Modes: A, VA, BTS, MS

:FORMat:DEXPort:HEADer[:STATe] ON | OFF

This command determines if the output file starts with a header (start frequency, sweep time, detector, .. = ON) or not. OFF = only measurement data is output.

Example: ":FORM:DEXP:HEAD OFF
Features: *RST value: ON
 SCPI: device specific
Modes: A, VA, BTS, MS

:FORMat:DEXPort:APPend[:STATe] ON | OFF

This command determines if the output file is overwritten or the data is added to the end of the file.

Example: ":FORM:DEXP:APP OFF
Features: *RST value: ON
 SCPI: device-specific
Modes: A, VA, BTS, MS

:FORMat:DEXPort:COMMeNt <string>

This command defines a comment for the output file.

Example: ":FORM:DEXP:COMM 'ASCII EXPORT TRACE 1'
Features: *RST value: "
 SCPI: conforming
Modes: A, VA, BTS, MS

HCOPY Subsystem

The HCOpy subsystem controls the output of display information for documentation purposes on output devices or files.

| COMMAND | PARAMETERS | UNIT | COMMENT |
|-------------------|---|------|---|
| HCOPY | | | |
| :ABORt | -- | | no query |
| :DEStination<1 2> | 'SYST:COMM:PRIN' 'SYST:COMM:CLIP' 'MMEM' | | no query, FSE with Windows NT controller |
| :DEStination<1 2> | 'SYST:COMM:GPIB' 'SYST:COMM:SER1' 'SYST:COMM:SER2' 'SYST:COMM:CENt' 'MMEM' | | no query, FSE without controller or with DOS controller |
| :DEVice | | | |
| :COLor | <Boolean> | | FSE with Windows NT controller |
| :LANGUage<1 2> | GDI EWMF BMP WMF | | FSE without controller or with DOS controller |
| :LANGUage<1 2> | HPGL PCL4 PCL5 POSTscript ESCP WMF PCX HP7470 EPSON24 EPSON24C PCL4_C PCL4_C3 LASERJ DESKJ DESKJ_C DESKJ_C3 HPGL_LS HP7470LS | | |
| :PRESet<1 2> | <Boolean> | | FSE without controller or with DOS controller |
| :RESolution<1 2> | <numeric_value> | | FSE without controller or with DOS controller |
| [:IMMediate<1 2>] | -- | | no query |
| :ITEM | | | |
| :ALL | | | no query |
| :FFEed<1 2> | | | |
| :STATe | <Boolean> | | |
| :LABel | | | |
| :TEXT | <string> | | |
| :PFEed<1 2> | | | |
| :STATe | <Boolean> | | |
| :WINDow<1 2> | | | |
| :TABLe | | | |
| :STATe | <Boolean> | | |
| :TEXT | <string> | | |
| :TRACe | | | |
| :STATe | <Boolean> | | |
| :CAINcrement | <Boolean> | | |
| :PAGE | | | |
| :DIMensions | | | |
| :QUADrant<1 to 4> | | | no query |
| :FULL | | | no query |
| :ORientation<1 2> | LANDscape PORTrait | | |

:HCOPY:ABORT

This command aborts a running hardcopy output.

Example: " :HCOP:ABOR "

Features: *RST value: -
SCPI: conforming

Modes: A, VA, BTS, MS

This command is an event which is why it is not assigned an *RST value and no query.

:HCOPY:DESTination<1|2> <string>

This command selects the interface and the configuration (1 or 2) for the hardcopy device. The availability of the parameters depends on the selected data format (see command :HCOPY:DEVIce:LANGUage). { XE "Softkey:SETTINGS DEVICE 1/2" }{ XE "Softkey:HARDCOPY DEVICE" }

Parameter:

FSE with NT controller <string>::= 'SYST:COMM:GPIB' |
'SYST:COMM:SER1' |
'SYST:COMM:SER2' |
'SYST:COMM:CENT' |
'MMEM'

FSE without controller / with DOS controller

Parameter: <string>::= 'MMEM' |
'SYST:COMM:PRIN' |
'SYST:COMM:CLIP'

Example: " :HCOP:DEST2 'MMEM' "

Features: *RST value: -
SCPI: conforming

Modes: A, VA, BTS, MS

This command is an event which is why it is not assigned an *RST value and no query.

:HCOPY:DESTination 'MMEM' creates a file for the hardcopy output. Command MMEM:NAME <file_name> defines the file name.

- 'MMEM' creates a file for the hardcopy output. Command MMEM:NAME <file_name> defines the file name. All formats can be selected for :HCOPY:DEVIce:LANGUage.
- 'SYST:COMM:PRIN' directs the hardcopy to the printer. The printer is selected with command SYSTEM:COMMunicate:PRINter:SElect. GDI should be selected for :HCOPY:DEVIce:LANGUage.
- 'SYST:COMM:CLIP' directs the hardcopy to the clipboard. EWMF should be selected for :HCOPY:DEVIce:LANGUage.
- 'SYST:COMM:GPIB' directs the hardcopy to the IEC/IEEE interface. All formats can be selected for :HCOPY:DEVIce:LANGUage.
- 'SYST:COMM:SER1' directs the hardcopy to the serial interface COM1. All formats can be selected for :HCOPY:DEVIce:LANGUage.
- 'SYST:COMM:CENT' directs the hardcopy to the parallel IEC/IEEE interface LPT. All formats can be selected for :HCOPY:DEVIce:LANGUage.

This command is an event which is why it is not assigned an *RST value and no query.

:HCOPY:DEVIce:COLor ON | OFF

This command selects between color and monochrome hardcopy of the screen.

Example: " :HCOP:DEV:COL ON"

Features: *RST value: OFF
SCPI: conforming

Modes: A, VA, BTS, MS

:HCOPY:DEVIce:LANGUage<1|2> WMF| EWMF | GDI | BMP (FSE with NT controller)

:HCOPY:DEVIce:LANGUage<1|2> HPGL | PCL4 | PCL5 | POSTscript | ESCP | WMF| PCX | HP7470 | EPSON24| EPSON24C | PCL4_C | PCL4_C3 | LASERJ | DESKJ | DESKJ_C | DESKJ_C3 | HPGL_LS | HP7470LS

This command determines the data format of the printout.

Example: " :HCOP:DEV:LANG WMF"

Features: *RST value: -
SCPI: conforming

Modes: A, VA, BTS, MS

HPGL data format for printout on a plotter in HPGL,

HP7470 special format for printout on a plotter hp7470 (reduced HPGL format)

HPGL_LS and HP7470LS special HPGL/HP7470-format allowing output of the traces with variable Line_styles

PCL4.and PCL5 generic data formats for laser and ink-jet printers, with Black/white

PCL4_C: Color (3 color cartridges + black cartridge)

PCL4_C3: Color (3 color cartridges only)

PCL5: Black/white with 300DPI resolution, new language version.

LASERJ Data format for HP-laserjet starting with series III

DESKJ... Data formats for printers of HP-deskjet series, with DESKJ: Black/white

DESKJ_C: Color (3 color cartridges + black cartridge, e. g. Deskjet 560)

DESKJ_C3: Color (3 color cartridges only, e. g. Deskjet 500)

POSTscript a printer language,

ESCP data format for a 24-pin printer.

EPSON24 data format for Epson-compatible 24-needle printers, black/white, e. g. Epson LQ-series, R&S PDN

EPSON24C data format for Epson-compatible 24-needle color printers, e. g. Epson Stylus Color, R&S PDN Color

WMF (WINDOWS Metafile Format), PCX (pixel graphics) and EWMF(Enhanced Metafile Format) data formats for output files which can at a later time be directly integrated in corresponding programs for documentation purposes.

BMP (Bitmap) Data format for output files (FSE with NT controller only).

GDI (Graphics Device Interface) Default format for the output to a printer configured under Windows. For the output file the printer driver configured under Windows is used and thus a printer-specific format is generated (FSE with NT controller only).

:HCOPY:DEVIce:PRESet<1|2> ON | OFF

This command resets the hardcopy unit (1 or 2) prior to generating the hardcopy (FSE without controller or with DOS controller only)

Example: " :HCOP:DEV:PRES2 ON "

Features: *RST value: OFF
 SCPI: device-specific

Modes: A, VA, BTS, MS

:HCOPY:DEVIce:RESolution<1|2> 150 | 300

This command controls the resolution of the printout in PCL4 and HP-deskjet format (hardcopy unit 1 or 2) (FSE without controller or with DOS controller only).

Example: " :HCOP:DEV:RES 300 "

Features: *RST value: 150
 SCPI: conforming

Modes: A, VA, BTS, MS

The resolution for an output in PCL4 format is between 150 dpi or 300 dpi.

:HCOPY[:IMMediate<1|2>]

This command starts a hardcopy output.

Example: "HCOP"

Features: *RST value: -
 SCPI: conforming

Modes: A, VA, BTS, MS

HCOP[1] starts the hardcopy output to device 1 (default), HCOP2 starts the output to device 2. This command is an event which is why it is not assigned an *RST value and has no query.

:HCOPY:ITEM:ALL

This command selects the complete screen to be output.

Example: " :HCOP:ITEM:ALL "

Features: *RST value: OFF
 SCPI: conforming

Modes: A, VA, BTS, MS

The hardcopy output is always provided with comments, title, time and date. As an alternative to the whole screen, only traces (commands ' :HCOPY:DEVIce:WINDow:TRACe: STATE ON ') or tables (command ' :HCOPY:DEVIce:WINDow:TABLE:STATE ON ') can be output.

:HCOPY:ITEM:FFEd<1|2>:STATe ON | OFF

The command adds a form feed command to the hardcopy output of the screen.

Example: " :HCOP:ITEM:FFE2:STAT ON"

Features: *RST value: OFF
SCPI: conforming

Modes: A, VA, BTS, MS

:HCOPY:ITEM:LABel:TEXT <string>

This command defines the title of the screen with a maximum of 60 characters.

Example: " :HCOP:ITEM:LAB:TEXT 'My Title' "

Features: *RST value: OFF
SCPI: conforming

Modes: A, VA, BTS, MS

:HCOPY:ITEM:PFEed<1|2>:STATe ON | OFF

This command adds a paper feed command to the hardcopy output of the screen (ON).

Example: " :HCOP:ITEM:PFE2:STAT ON"

Features: *RST value: OFF
SCPI: device-specific

Modes: A, VA, BTS, MS

:HCOPY:ITEM:WINDow<1|2>:TABLe:STATe ON | OFF

This command selects the output of the currently displayed tables (ON).

Example: " :HCOP:ITEM:WIND:TABL:STAT ON"

Features: *RST value: OFF
SCPI: device-specific

Modes: A, VA, BTS, MS

The command `:HCOPY:ITEM:WINDow<1|2>:TABLe:STATe` OFF same as command
`:HCOPY:ITEM:ALL` enables the output of the whole screen.

:HCOPY:ITEM:WINDow<1|2>:TEXT <string>

This command defines the comment text for printout to trace 1 or 2 with a maximum of 100 characters.

Example: " :HCOP:ITEM:WIND2:TEXT 'comment' "

Features: *RST value: -
SCPI: device-specific

Modes: A, VA, BTS, MS

:HCOPY:ITEM:WINDow<1|2>:TRACe:STATe ON | OFF

This command selects the output of the currently displayed trace (ON).

Example: " :HCOP:ITEM:WIND:TRACe:STAT ON "

Features: *RST value: OFF
SCPI: device-specific

Modes: A, VA, BTS, MS

The command :HCOPY:ITEM:WINDow<1 | 2>:TRACe:STATe OFF same as command :HCOPY:ITEM:ALL enables the output of the whole screen.

:HCOPY:ITEM:WINDow<1|2>:TRACe:CAINcrement ON | OFF

The command automatically changes the colour of the currently displayed trace after printout (ON).

Example: " :HCOP:ITEM:WIND:TRACe:CAIN ON "

Features: *RST value: OFF
SCPI: device-specific

Modes: A, VA, BTS, MS

The automatic change of colour of the trace allows outputting to a plotter of several traces of the same diagram. For a better distinction, the colour of the trace is changed ("Color Auto Increment").

:HCOPY:PAGE:DIMensions:QUADrant<1 to 4>

The command defines the quadrant which is allocated to the screen output.

Example: " :HCOP:PAGE:DIM:QUAD1 "

Features: *RST value: -
SCPI: conforming

Modes: A, VA, BTS, MS

The quadrants are defined as QUAD1 at the top right, QUAD2 at the top left, QUAD3 at the bottom left and QUAD4 at the bottom right. This command is an event which is why it is not assigned an *RST value and has no query.

:HCOPY:PAGE:DIMensions:FULL

This command defines that the full screen is to be printed out.

Example: " :HCOP:PAGE:DIM:FULL "

Features: *RST value: -
SCPI: device-specific

Modes: A, VA, BTS, MS

This command is an event which is why it is not assigned an *RST value and has no query.

:HCOPY:PAGE:ORientation<1|2> LANDscape | PORTrait

The command selects the format of the output (portrait and landscape) (hardcopy unit 1 or 2).

Example: " :HCOP:PAGE:ORI LAND "

Features: *RST value: -
SCPI: conforming

Modes: A, VA, BTS, MS

INITiate Subsystem

The INITiate subsystem checks the initialization of the trigger subsystem. In the split-screen representation, a distinction is made between INITiate1 (screen A) and INITiate2 (screen B)

| COMMAND | PARAMETERS | UNIT | COMMENT |
|---------------|------------|------|----------|
| INITiate<1 2> | | | |
| :CONTinuous | <boolean> | -- | |
| :CONMeas | -- | -- | no query |
| [:IMMediate] | -- | -- | no query |
| :DISPlay | <boolean> | -- | |

:INITiate<1|2>:CONTinuous ON | OFF

This command determines if the trigger system is continuously initiated ("Free Run").

Example: " :INIT:CONT OFF "

Features: *RST value: ON
SCPI: conforming

Modes: A, VA, BTS, MS

Setting "INITiate:CONTinuous ON" corresponds to function SWEEP CONTinuous, ie the sweep of the analyzer is cyclically repeated. The setting "INITiate:CONTinuous OFF" corresponds to function SWEEP SINGLE.

:INITiate<1|2>:CONMeas

This command continues the sweep from the current sweep position.

Example: " :INIT:CONM "

Features: *RST value: -
SCPI: device-specific

Modes: A, VA, BTS, MS

This command is an event and therefore has no *RST value and no query.

Sweeps are stopped, for example, in the case of transducer sets between the different transducer factors.

:INITiate<1|2>[:IMMediate]

The command initiates a new sweep or starts a single sweep.

Example: " INIT "

Features: *RST value: -
SCPI: conforming

Modes: A, VA, BTS, MS

This command is an event which is why it is not assigned an *RST value and has no query.

:INITiate<1|2>:DISPlay ON | OFF

This command switches the display on or off during a single sweep.

Example: " :INIT:DISP OFF "

Features: *RST value: ON
SCPI: device-specific

Modes: A, VA, BTS, MS

INPut Subsystem

The INPut subsystem checks the input features of the instrument. In the split-screen representation, a distinction is made between INPut1 (screen A) and INPut2 (screen B).

| COMMAND | PARAMETERS | UNIT | COMMENT |
|--------------|-----------------------------|------|------------------------|
| INPut<1 2> | | | |
| :ATTenuation | <numeric_value> | DB | |
| :AUTO | <Boolean> | -- | |
| :MODE | NORMal LNOise LDIStortion | -- | |
| :STEPsize | 1 10 | dB | Option 1-dB attenuator |
| :UPORt<1 2> | | | |
| [:VALue]? | -- | -- | query only |
| :STATe | <Boolean> | -- | |
| :IMPedance | 50 75 | OHM | |
| :CORRection | RAM RAZ | | |
| :MIXer | <numeric_value> | DBM | |

:INPut<1|2>:ATTenuation 0 to 70 dB

This command programs the input attenuator.

Example: " : INP : ATT 40dB "

Features: *RST value: - (AUTO is set to ON)
SCPI: conforming

Modes: A, VA

The attenuation of the input calibration line can be programmed in steps of 10 dB. If the attenuation is programmed directly, the coupling to the reference level is switched off.

:INPut<1|2>:ATTenuation:AUTO ON | OFF

This command automatically couples the input attenuation to the reference level (analyzer).

Example: " : INP : ATT : AUTO ON "

Features: *RST value: ON
SCPI: conforming

Modes: A, VA

:INPut<1|2>:ATTenuation:AUTO:MODE NORMal | LNOise | LDIStortion

This command optimizes the coupling of the input attenuation to the reference level to high sensitivity or to high intermodulation immunity.

Example: " : INP : ATT : AUTO : MODE LDIS "

Features: *RST value: ON
SCPI: device-specific

Modes: A, VA

For LNOise, the input attenuator value is set 10 dB lower than for INPut:ATTenuation:AUTO:MODE NORMal, for LDIStortion it is set 10 dB higher.

:INPut<1|2>:ATTenuation:STEPsize 1dB | 10dB

This command defines the attenuator stepsize.

Example: " :INP:ATT:STEP 1dB "

Features: *RST value: 10dB
SCPI: device-specific

Mode: A, VA, BTS, MS

This command is only available in conjunction with option FSE-B13, 1-dB attenuator.

:INPut<1|2>:UPORt<1|2>[:VALue]?

This command queries the control lines of the user ports.

Example: " :INP:UPOR2? "

Features: *RST value: -
SCPI: device-specific

Modes: A, VA, BTS, MS

This command is a query command which is why it is not assigned an *RST value.

:INPut<1|2>:UPORt<1|2>:STATe ON | OFF

This command toggles the control lines of the user ports between INPut and OUTPut.

Example: " :INP:UPOR2:STAT ON "

Features: *RST value: ON
SCPI: device-specific

Modes: A, VA, BTS, MS

With ON, the user port is switched to INPut, with OFF to OUTPut.

:INPut<1|2>:IMPedance 50 | 75

This command sets the nominal input impedance of the instrument.

Example: " :INP:IMP 75 "

Features: *RST value: 50
SCPI: conforming

Modes: A, VA, BTS, MS

Switching the input impedance to 75 Ω includes the matching elements RAM or RAZ selected by the command INPut:IMPedance:CORRection.

:INPut<1|2>:IMPedance:CORRection RAM | RAZ

This command selects the matching element for 75 Ω input impedance.

Example: " : INP : IMP : CORR RAM "

Features: *RST value: - (INPut:IMPedance = 50 Ω)
SCPI: device-specific

Modes: A, VA, BTS, MS

:INPut<1|2>:MIXer -10 to -100 dBm

This command defines the nominal mixer level of the instrument.

Example: " : INP : MIX -30 "

Features: *RST value: -
SCPI: device-specific

Modes: A, VA

INSTRument Subsystem

The INSTRument subsystem selects the operating mode of the unit either via text parameters or fixed numbers. In the split-screen representation, a distinction is made between INSTRument1 (screen A) and INSTRument2 (screen B).

| COMMAND | PARAMETERS | UNIT | COMMENT |
|--|--|------|---|
| INSTRument<1 2> [:SElect] :NSElect :COUPled | SANalyzer DDEMod ADEMod BSGM MGSM <numeric_value> NONE MODE X Y CONTRol XY XCONTRol YCONTRol ALL | | Vector Signal Analysis FSE-K11 or FSE-K10, |

:INSTRument<1|2>[:SElect] SANalyzer | DDEMod | ADEMod | BSGM | MGSM

This command switches between the operating modes by means of text parameters.

Parameter: SANalyzer: spectrum analysis
DDEMod: vector signal analysis, digital demodulation
ADEMod: vector signal analysis, analog demodulation
BSGM: GSM BTS analysis
MGSM: GSM MS analysis

Example: " :INST DDEM"

Features: *RST value: SANalyzer
SCPI: conforming

Modes: A, VA, BTS, MS

Switchover to DDEMod or ADEMod is only possible in conjunction with option FSE-B7, Vector Signal Analysis.

Switchover to BSGM is only possible in conjunction with option FSE-K11, GSM BTS Analyzer

Switchover to MGSM is only possible in conjunction with option FSE-K10, GSM MS Analyzer

:INSTRument<1|2>:NSElect 1 to 5

This command switches between the two modes by means of numbers.

Example: " :INST:NSEL 2"

Features: *RST value: 1
SCPI: conforming

Modes: A, VA, BTS, MS
1: spectrum analysis
2: vector signal analysis, digital demodulation
3: vector signal analysis, analog demodulation
4: GSM BTS analysis
5: GSM MS analysis

Switchover to 2 or 3 is only possible in conjunction with option FSE-B7, Vector Signal Analysis.

Switchover to 4 is only possible in conjunction with option FSE-K11, GSM BTS Analyzer

Switchover to 5 is only possible in conjunction with option FSE-K10, GSM MS Analyzer

:INSTrument<1|2>:COUPlE NONE | MODE | X | Y | CONTrol | XY | XCONtrol | YCONtrol | ALL

This command defines the coupling between the two measurement windows screen A and B.

Example: " :INST:COUP NONE "

Features: *RST value: ALL
SCPI: device specific

Modes: A, VA

NONE no coupling.

MODE the operating mode of the two screens is coupled.

X or Y the scaling of the x- or y axis of the two screens is coupled.

CONTrol the trigger and gate parameter ,and the sweep parameters SINGle/ CONTInous and COUNT of the two screens are coupled.

XY the scaling of the x- and y-axis of the two screens are coupled.

XCONtrol bzw. YCONtrol the trigger and gate parameter, and the sweep parameters SINGle CONTInous/ COUNT of the two screens are coupled.

ALL the scaling of the x- or y axis the trigger and gate parameter and the sweep parameters SINGle/ CONTInous/ COUNT of the two screens are coupled.

The numeric suffix in INSTrument<1|2> is not significant.

MMEMory Subsystem

The MMEMory (mass memory) subsystem provides commands which allow for access to the storage media of the instrument and for storing and loading various instrument settings.

The NAME command stores the HCOPY outputs in a file.

The various drives can be addressed via the mass storage unit specifier <msus> using the conventional DOS syntax. The internal hard disk is addressed by "C:", the floppy-disk drive installed by "A:".

The file names <file_name> are indicated as string parameters with the commands being enclosed in quotation marks. They correspond to the DOS conventions.

DOS file names consist of max. 8 ASCII characters and an extension of up to three characters separated from the file name by a colon "." Both, the colon and the extension are optional. The colon is not part of the file name. DOS file names do not differ between uppercase and lowercase notation. All letters and digits are permitted as well as the special characters "_", "^", "\$", "~", "!", "#", "%", "&", "-", "{", "}", "(", ")", "@", and "'". Reserved file names are CLOCK\$, CON, AUX, COM1 to COM4, LPT1 to LPT3, NUL and PRN.

The two characters "*" and "?" have the function of so-called "wildcards", i.e., they are variables for selection of several files. The question mark "?" replaces exactly one character which may be any, the asterisk means any of the remaining characters in the file name. "*. *" thus means all files in a directory.

| COMMAND | PARAMETERS | UNIT | COMMENT |
|-------------|-----------------------------|------|----------|
| MMEMory | | | |
| :CATalog | <string> | | |
| :CDIRectory | <directory_name> | -- | |
| :COPY | <file_name>,<file_name> | -- | no query |
| :DATA | <file name>[,<block>] | -- | |
| :DELeTe | <file_name> | -- | no query |
| :INITialize | <msus> | -- | no query |
| :LOAD | | | |
| :STATe | 1,<file_name> | -- | no query |
| :AUTO | 1,<file_name> | -- | no query |
| :MDIRectory | <directory_name> | -- | no query |
| :MOVE | <file_name>,<file_name> | -- | no query |
| :MSIS | <msus> | -- | |
| :NAME | <file_name> | -- | |
| :RDIRectory | <directory_name> | -- | no query |
| :STORe | | | |
| :STATe | 1,<file_name> | -- | no query |
| :TRACe | <numeric_value>,<file_name> | | no query |
| :CLEar | | | |
| :STATe | 1,<file_name> | -- | no query |
| :ALL | | | no query |

| COMMAND | PARAMETERS | UNIT | COMMENT |
|----------------|------------|------|---------------------------|
| MMEMemory | | | |
| :SElect | | | |
| [:ITEM] | | | |
| :GSEtup | <Boolean> | | |
| :HWSEttings | <Boolean> | | |
| :TRACE<1 to 4> | <Boolean> | | |
| :LINes | | | |
| [:ACTive] | <Boolean> | | |
| :ALL | <Boolean> | | |
| :CSEtup | <Boolean> | | |
| :HCOPY | <Boolean> | | |
| :MACROs | <Boolean> | | |
| :SCData | <Boolean> | | Option Tracking Generator |
| :TRANsducer | | | |
| [:ACTive] | <Boolean> | | |
| :ALL | <Boolean> | | |
| :CVL | | | |
| [:ACTive] | <Boolean> | | |
| :ALL | <Boolean> | | |
| :ALL | -- | | no query |
| :NONE | -- | | no query |
| :DEFault | -- | | no query |
| :COMMeNt | <string> | | |

:MMEMemory:CATalog? <string>

This command reads out the files and subdirectories of the current directory. A mask, eg "*.bat", can be defined so that only files with "bat" as extension are selected.

Syntax of output format:

<Sum of file lengths of all subsequent files>,<free memory on hard disk>,
 <1st file name or name of subdirectory>,<file or subdirectory>,<1st file length>,<2nd file name or name of subdirectory>,<file or subdirectory>,<2nd file length>,<...>,<nth file name>,<file or subdirectory>,<nth file length>.

<File or subdirectory>: in case of a file the field remains empty,
 in case of a subdirectory the field contains "DIR".

Parameter: <string>:= DOS file name

Example: ":MMEMemory:CAT 'rem?.lin' "

Characteristics: *RST value: -
 SCPI: conformal

Modes: A, VA, BTS, MS

:MMEMory:CDIRectory <directory_name>

This command changes the current directory.

Parameter: <directory_name> ::= DOS path name

Example: " :MMEM:CDIR 'C:\USER\DATA' "

Features: *RST value: -
SCPI: conforming

Modes: A, VA, BTS, MS

In addition to the path name, the indication of the directory may contain the drive name. The path name complies with the DOS conventions.

:MMEMory:COPY <file_source>,<file_destination>

This command copies the files indicated.

Parameter: <file_source>,<file_destination> ::= <file_name>
<file_name> ::= DOS file name

Example: " :MMEM:COPY 'C:\USER\DATA\SETUP.CFG' , 'A: ' "

Features: *RST value: -
SCPI conforming

Modes: A, VA, BTS, MS

The indication of the file name may include the path and the drive. The file names and path information must be in accordance with the DOS conventions. This command is an event which is why it is not assigned an *RST value and has no query.

:MMEMory:DATA <file_name>[,<block data>]

This command writes block data to the specified file.

Syntax: :MMEMory:DATA <file_name>,<block data>
:MMEMory:DATA? <file_name>

Example: " :MMEM:DATA? 'TEST01.HCP' "
" :MMEM:DATA 'TEST01.HCP' , #217This is the file"

Features: *RST value: -
SCPI: conforming

Modes: A, VA, BTS, MS

Each <block> starts with the character '#', followed by the value stating the length of the length information. This is followed by one or several characters for the length information; then come the data themselves. The end character must be set to EOI to ensure correct data transmission.

:MMEMory:DELeTe <file_name>

This command deletes the files indicated.

Parameter: <file_name> ::= DOS file name

Example: " :MMEM:DEL 'TEST01.HCP' "

Features: *RST value: -
SCPI: conforming

Modes: A, VA, BTS, MS

The indication of the file name contains the path and, optionally, the drive. Indication of the path corresponds to the DOS conventions. The file name includes indication of the path and may also include the drive. The path name corresponds to the DOS conventions. This command is an event which is why it is not assigned an *RST value and has no query.

:MMEMory:INITialize 'A:'

This command formats the disk in drive A.

Example: " :MMEM:INIT 'A:' "

Features: *RST value: -
SCPI: conforming

Modes: A, VA, BTS, MS

Formatting deletes all data stored on the floppy disk. This command is an event which is why it is not assigned an *RST value and has no query.

:MMEMory:LOAD:STATe 1,<file_name>

This command loads instrument settings from files.

Parameter: <file_name> ::= DOS file name without extension

Example: " :MMEM:LOAD:STAT 1, 'A:TEST' "

Features: *RST value: -
SCPI: conforming

Modes: A, VA, BTS, MS

The contents of the file is loaded and set as new instrument state. The file name includes indication of the path and may also include the drive. The path name corresponds to the DOS conventions. This command is an event which is why it is not assigned an *RST value and has no query.

:MMEMory:LOAD:AUTO 1,<file_name>

This command defines which device setting is automatically loaded after the instrument is switched on.

Parameter: <file_name> ::= DOS file name without extension;
FACTORY denotes the data set previously in the instrument

Example: " :MMEM:LOAD:AUTO 1, 'C:\USER\DATA\TEST' "

Features: *RST value: -
SCPI: device-specific

Modes: A, VA, BTS, MS

The contents of the file are read after switching on the instrument and used to define the new device state. The file name includes indication of the path and may also include the drive. The path name corresponds to the DOS conventions. This command is an event which is why it is not assigned an *RST value and has no query.

:MMEMory:MDIRectory <directory_name>

This command creates a new directory.

Parameter: <directory_name> ::= DOS path name

Example: " :MMEM:MDIR 'C:\USER\DATA' "

Features: *RST value: -
SCPI: device-specific

Modes: A, VA, BTS, MS

The file name includes indication of the path and may also include the drive. The path name corresponds to the DOS conventions. This command is an event which is why it is not assigned an *RST value and has no query.

:MMEMory:MOVE <file_source>,<file_destination>

This command renames existing files.

Parameter: <file_source>,<file_destination> ::= <file_name>
<file_name> ::= DOS file name

Example: " :MMEM:MOVE 'TEST01.CFG', 'SETUP.CFG' "

Features: *RST value: -
SCPI: conforming

Modes: A, VA, BTS, MS

The file name includes indication of the path and may also include the drive. The path name corresponds to the DOS conventions. This command is an event which is why it is not assigned an *RST value and has no query.

:MMEMory:MSIS 'A:' | 'C:'

This command changes to the drive indicated.

Example: " :MMEM:MSIS 'A:' "

Features: *RST value: "C:"
SCPI: conforming

Modes: A, VA, BTS, MS

The drive may be the internal hard disk C: or the floppy-disk drive A:. The drive is indicated according to the DOS conventions.

:MMEMory:NAME <file_name>

This command specifies a file which is printed or plotted to.

Parameter: <file_name> ::= DOS filename

Example: " :MMEM:NAME 'PLOT1.HPG' "

Features: *RST value: -
SCPI: conforming

Modes: A, VA, BTS, MS

The file name includes indication of the path and may also include the drive. The file name and path information correspond to the DOS conventions. The output to the printer is routed into a file using the command " :HCOP:DEST 'MMEM'".

:MMEMory:RDIRectory <directory_name>

This command deletes the directory indicated.

Parameter: <directory_name> ::= DOS path name

Example: " :MMEM:RDIR 'C:\TEST' "

Features: *RST value: -
SCPI: device-specific

Modes: A, VA, BTS, MS

The directory name includes indication of the path and may also include the drive. The path name corresponds to the DOS conventions. This command is an event which is why it is not assigned an *RST value and has no query.

:MMEMory:STORe:STATe 1,<file_name>

This command stores the current instrument setting in a file.

Parameter: <file_name> ::= DOS file name without extension

Example: " :MMEM:STOR:STAT 1, 'TEST' "

Features: *RST value: -
SCPI: conforming

Modes: A, VA, BTS, MS

The current instrument state is stored as a file. The file name includes indication of the path and may also include the drive. The path name corresponds to the DOS conventions. This command is an event which is why it is not assigned an *RST value and has no query.

:MMEMory:STORe:TRACe 1 to 4,<file_name>

This command stores the selected trace (1 to 4) in ASCII format in a file.

Parameter: 1 to 4 := selected trace 1 to 4
<file_name> := DOS file name

Example: " :MMEM:STOR:TRAC 3 , 'A:\TEST.ASC' "

Features: *RST value: -
SCPI: device-specific

Modes: A, VA, BTS, MS

The file name includes indication of the path and may also include the drive. The file name and path information correspond to the DOS conventions. This command is an event which is why it is not assigned an *RST value and has no query.

:MMEMory:CLEAr:STATe 1,<file_name>

This command deletes the instrument setting denoted by <file_name>.

Parameter: <file_name> ::= DOS file name without extension

Example: " :MMEM:CLE:STAT 1 , 'TEST' "

Features: *RST value: -
SCPI: device-specific

Modes: A, VA, BTS, MS

The device data set specified is deleted. The file name includes indication of the path and may also include the drive. The path name corresponds to the DOS conventions. This command is an event which is why it is not assigned an *RST value and has no query.

:MMEMory:CLEAr:ALL

This command deletes all instrument settings in the current directory.

Example: " :MMEM:CLE:ALL "

Features: *RST value: -
SCPI: device-specific

Modes: A, VA, BTS, MS

This command is an "event" which is why it is not assigned an *RST value and has no query.

:MMEMory:SELEct[:ITEM]:GSETup ON | OFF

This command includes the data of the general setup in the list of data subsets of a device setting to be stored/loaded.

Example: " :MMEM:SEL:GSET ON "

Features: *RST value: OFF
SCPI: device-specific

Modes: A, VA, BTS, MS

:MMEMory:SELEct[:ITEM]:HWSEttings ON | OFF

This command includes the hardware settings in the list of data subsets of a device setting to be stored/loaded.

Example: " :MMEM:SEL:HWS ON "

Features: *RST value: ON
SCPI: device-specific

Modes: A, VA, BTS, MS

Level and frequency lines are stored with this command as well.

:MMEMory:SELEct[:ITEM]:TRACe<1 to 4> ON | OFF

This command includes the data of the selected trace in the list of data subsets of a device setting to be stored/loaded.

Example: " :MMEM:SEL:TRACE3 ON "

Features: *RST value: OFF for all Traces
SCPI: device-specific

Modes: A, VA, BTS, MS

:MMEMory:SELEct[:ITEM]:LINes[:ACTive] ON | OFF

This command includes the active limit lines in the list of data subsets of a device setting to be stored/loaded.

Example: " :MMEM:SEL:LIN ON "

Features: *RST value: ON
SCPI: device-specific

Modes: A, VA, BTS, MS

Upon `MMEM:LOAD` the limit lines which are not currently active but contained in the data set are restored as well.

:MMEMory:SELEct[:ITEM]:LINes:ALL ON | OFF

This command includes all limit lines in the list of data subsets of a device setting to be stored/loaded.

Example: " :MMEM:SEL:LIN:ALL ON "

Features: *RST value: ON
SCPI: device-specific

Modes: A, VA, BTS, MS

This command includes selection of the active limit lines.

:MMEMory:SELEct[:ITEM]:CSEtup ON | OFF

This command includes the current color setting in the list of partial datasets of a device setting to be stored/loaded.

Example: " :MMEM:SEL:CSET ON "

Features: *RST value: ON
SCPI: device-specific

Modes: A, VA, BTS, MS

:MMEMory:SELEct[:ITEM]:HCOPy ON | OFF

This command includes the hardcopy settings in the list of data subsets of a device setting to be stored/loaded.

Example: " :MMEM:SEL:HCOPY ON "

Features: *RST value: ON
SCPI: device-specific

Modes: A, VA, BTS, MS

:MMEMory:SELEct[:ITEM]:MACROs ON | OFF

This command includes the keyboard macros in the list of data subsets of a device setting to be stored/loaded.

Example: " :MMEM:SEL:MACROs ON "

Features: *RST value: OFF
SCPI: device-specific

Modes: A, VA, BTS, MS

:MMEMory:SELEct[:ITEM]:SCData ON | OFF

This command includes the tracking generator calibration data in the list of data subsets of a device setting to be stored/loaded.

Example: " :MMEM:SEL:SCData ON "

Features: *RST value: OFF
SCPI: device-specific

Modes: A, VA

This command only available in conjunction with the option Tracking Generator.

:MMEMory:SELEct[:ITEM]:TRANsducer[:ACTive] ON | OFF

This command includes the active transducer factors and set in the list of data subsets of a device setting to be stored/loaded.

Example: " :MMEM:SEL:TRAN ON "

Features: *RST value: ON
SCPI: device-specific

Modes: A, VA, BTS, MS

Upon `MMEM:LOAD` the transducer factors and sets which are not currently active but contained in the data set are restored as well.

:MMEMory:SElect[:ITEM]:TRANsducer:ALL ON | OFF

This command includes all transducer factors and sets in the list of data subsets of a device setting to be stored/loaded.

Example: " :MMEM:SEL:TRAN:ALL ON "

Features: *RST value: ON
SCPI: device-specific

Modes: A, VA, BTS, MS

This command is an event and therefore has no *RST value assigned.

:MMEMory:SElect[:ITEM]:CVL[:ACTive] ON | OFF

This command includes the active conversion loss table into the list of data subrecords to be stored / loaded for a device setup.

Example: " :MMEM:SEL:CVL ON "

Features: *RST value: OFF
SCPI: device-specific

Modes: A, VA, BTS, MS

This command is available only in conjunction with option External Mixer Output, FSE-B21.

:MMEMory:SElect[:ITEM]:CVL:ALL ON | OFF

This command includes all conversion loss table into the list of data subrecords to be stored / loaded for a device setup.

Example: " :MMEM:SEL:CVL ON "

Features: *RST value: OFF
SCPI: device-specific

Modes: A, VA, BTS, MS

This command is available only in conjunction with option External Mixer Output, FSE-B21.

:MMEMory:SElect[:ITEM]:ALL

This command includes all data subsets in the list of data subsets of a device setting to be stored/loaded.

Example: " :MMEM:SEL:ALL "

Features: *RST value: --
SCPI: device-specific

Modes: A, VA, BTS, MS

This command is an event and therefore has no *RST value assigned.

:MMEMory:SElect[:ITEM]:NONE

This command deletes all data subsets in the list of data subsets of a device setting to be stored/loaded.

Example: " :MMEM:SEL:NONE "

Features: *RST value: --
SCPI: device-specific

Modes: A, VA, BTS, MS

This command is an event and therefore has no *RST value assigned.

:MMEMory:SElect[:ITEM]:DEFault

This command sets the default list of the data subsets of a device setting to be stored/loaded.

Example: " :MMEM:SEL:DEFault "

Features: *RST value: --
SCPI: device-specific

Modes: A, VA, BTS, MS

This command is an event and therefore has no *RST value assigned.

:MMEMory:COMment <string>

This command defines a comment for a device setting to be stored.

Example: " :MMEM:COMM 'Setup for GSM measurement' "

Features: *RST value: blank comment
SCPI: device-specific

Modes: A, VA, BTS, MS

OUTPut Subsystem

The OUTPut subsystem checks the output features of the instrument. In conjunction with option tracking generator, in the split screen mode, a distinction is made between OUTPut1 (screen A) and OUTPut2 (screen B).

| COMMAND | PARAMETERS | UNIT | COMMENT |
|-------------------------|-----------------|----------------------------------|---------------------------|
| OUTPut<1 2> [:STATe] | <boolean> | -- | Option Tracking Generator |
| :UPORt<1 2> [:VALue] | <binary> | -- | |
| :STATe | <boolean> | -- | |
| :AF :SENSitivity | <numeric_value> | PCT HZ KHZ DEG RAD | Vector Signal Analysis |

:OUTPut<1|2>[:STATe] ON | OFF

This command switches the tracking generator on or off.

Example: " :OUTP ON"

Features: *RST value: -
SCPI: conforming

Modes: A, VA

This command is only valid in conjunction with one of the options tracking generator.

:OUTPut<1|2>UPORt<1|2>[:VALue] #B00000000 to #B11111111

This command sets the control lines of the user ports.

Example: " :OUTP:UPOR2 #B10100101"

Features: *RST value: -
SCPI: device-specific

Modes: A, VA, BTS, MS

User port 1 or 2 is written with the given binary pattern. If the user port is programmed to INPut instead of OUTPut, the output value is temporarily stored.

:OUTPut<1|2>UPORt<1|2>:STATe ON | OFF

This command switches the control line of the user ports between INPut and OUTPut.

Example: " :OUTP:UPOR:STAT ON"

Features: *RST value: OFF
SCPI: device-specific

Modes: A, VA, BTS, MS

With ON, the user port is switched to OUTPut, with OFF to INPut.

:OUTPut<1|2>AF:SENSitivity <numeric_value>

This command changes the sensitivity of the AF-output.

Parameter: <numeric_value> ::= 0.1 PCT to 100 PCTfor AM
0.1 KHZ to 100 KHZfor FM
0.0 1RAD to 10 RADfor PM

Example: " :OUTP:AF:SENS 20PCT"

Features: *RST value: 100 % for AM
100 kHz for FM
10 rad for PM
SCPI: device-specific

Mode: VA-A

READ Subsystem

The READ-subsystem contains commands for starting complex measurement tasks such as those provided by options GSM BTS Analyzer (FSE-K11) or GSM MS Analyzer (FSE-K10), and for querying the results subsequently. The READ-subsystem is closely linked to the functions of the CONFigure- and FETCh-subsystems, where the measurement sequences are configured or the results are queried without restarting a new measurement.

READ:BURSt Subsystem

This subsystem provides the commands for starting measurements in the GSM BTS Analyzer mode (option FSE-K11), which are performed on individual bursts (carrier power, phase/frequency error), and for reading out the results subsequently.

| COMMAND | PARAMETERS | UNIT | COMMENT |
|---------------|------------|------|---------------------------|
| READ | | | |
| :BURSt | | | Option FSE-K11 or FSE-K10 |
| :PERRor | | | |
| :RMS | | | |
| :STATus? | -- | | query only |
| :AVERage? | -- | | query only |
| :MAXimum? | -- | | query only |
| :PEAK | | | |
| :STATus? | -- | | query only |
| :AVERage? | -- | | query only |
| :MAXimum? | -- | | query only |
| :FERRor | | | |
| :STATus? | -- | | query only |
| :AVERage? | -- | | query only |
| :MAXimum? | -- | | query only |
| :POWer? | -- | | |
| :STATic? | -- | | query only; FSE-K11 only |
| :DYNamic? | -- | | query only; FSE-K11 only |
| :LEVel? | -- | | query only; FSE-K10 only |
| :REFerence | | | |
| [:IMMEDIATE]? | -- | | query only |
| :MACCuracy | | | |
| :RMS | | | |
| :STATus? | -- | | query only |
| :AVERage? | -- | | query only |
| :MAXimum? | -- | | query only |
| :PEAK | | | |
| :STATus? | -- | | query only |
| :AVERage? | -- | | query only |
| :MAXimum? | -- | | query only |

| COMMAND | PARAMETERS | UNIT | COMMENT |
|-------------|------------|------|------------|
| READ | | | |
| :BURSt | | | |
| :MACCuracy | | | |
| :OSUPpress | | | |
| :STATus? | -- | | query only |
| :AVERAge? | -- | | query only |
| :MAXimum? | -- | | query only |
| :PERCentile | | | |
| :STATus? | -- | | query only |
| :AVERAge? | -- | | query only |
| :MAXimum? | -- | | query only |
| :FREQuency | | | |
| :STATus? | -- | | query only |
| :AVERAge? | -- | | query only |
| :MAXimum? | -- | | query only |

:READ:BURSt:PERRor:RMS:STATus?

This command starts the measurement of the phase and frequency error of the base station or mobile and reads out the status of the RMS-measurement of the phase error taken over the selected number of bursts.

0: failed, 1: passed

Example: " :READ: BURS: PERR: RMS: STAT? "

Features: *RST value: --
SCPI: device-specific

Modes: BTS, MS

When the measurement is started the instrument automatically assumes the SINGLE mode.

An ongoing measurement can be aborted via the command `ABORT`. Further results of the phase/frequency error measurement can be then queried without restart of the measurement via the `:FETCh: BURSt`-subsystem.

This command is a query only and therefore has no *RST value assigned. It is available only if measurement of the phase/frequency error is selected (see `:CONFigure: BURSt: PFERror`).

:READ:BURSt:PERRor:RMS:AVERAge?

This command starts the measurement of the phase and frequency error of the base station or mobile and reads out the average of the RMS-measurement of the phase error taken over the selected number of bursts.

Example: " :READ: BURS: PERR: RMS: AVER? "

Features: *RST value: --
SCPI: device-specific

Modes: BTS, MS

When the measurement is started the instrument automatically assumes the SINGLE mode.

An ongoing measurement can be aborted via the command `ABORT`. Further results of the phase/frequency error measurement can be then queried without restart of the measurement via the `:FETCh: BURSt`-subsystem.

This command is a query only and therefore has no *RST value assigned. It is available only if measurement of the phase/frequency error is selected (see `:CONFigure: BURSt: PFERror`).

:READ:BURSt:PERRor:RMS:MAXimum?

This command starts the measurement of the phase and frequency error of the base station or mobile and reads out the maximum of the RMS-measurement of the phase error for the selected number of bursts.

Example: " :READ: BURS: PERR: RMS: MAX? "

Features: *RST value: --
SCPI: device-specific

Modes: BTS, MS

When the measurement is started the instrument automatically assumes the SINGLE mode.

An ongoing measurement can be aborted via the command `ABORT`. Further results of the phase/frequency error measurement can be then queried without restart of the measurement via the `:FETCh: BURSt`-subsystem.

This command is a query only and therefore has no *RST value assigned. It is available only if measurement of the phase/frequency error is selected (see `:CONFigure: BURSt: PFERror`).

:READ:BURSt:PERRor:PEAK:STATus?

This command starts the measurement of the phase and frequency error of the base station or mobile and reads out the status of the peak measurement of the phase error taken over the selected number of bursts.

0: failed, 1: passed

Example: " :READ: BURS: PERR: PEAK: STAT? "

Features: *RST value: --
SCPI: device-specific

Modes: BTS, MS

When the measurement is started the instrument automatically assumes the SINGLE mode.

An ongoing measurement can be aborted via the command `ABORT`. Further results of the phase/frequency error measurement can be then queried without restart of the measurement via the `:FETCh: BURSt`-subsystem.

This command is a query only and therefore has no *RST value assigned. It is available only if measurement of the phase/frequency error is selected (see `:CONFigure: BURSt: PFERror`).

:READ:BURSt:PERRor:PEAK:AVERAge?

This command starts the measurement of the phase and frequency error of the base station or mobile and reads out the maximum of the peak measurement of the phase error taken over the selected number of bursts.

Example: " :READ: BURS: PERR: PEAK: AVER? "

Features: *RST value: --
SCPI: device-specific

Modes: BTS, MS

When the measurement is started the instrument automatically assumes the SINGLE mode.

An ongoing measurement can be aborted via the command `ABORT`. Further results of the phase/frequency error measurement can be then queried without restart of the measurement via the `:FETCh: BURSt`-subsystem.

This command is a query only and therefore has no *RST value assigned. It is available only if measurement of the phase/frequency error is selected (see `:CONFigure: BURSt: PFERror`).

:READ:BURSt:PERRor:PEAK:MAXimum?

This command starts the measurement of the phase and frequency error of the base station or mobile and reads out the maximum of the peak measurement of the phase error for the selected number of bursts.

Example: " :READ: BURS: PERR: PEAK: MAX? "

Features: *RST value: --
 SCPI: device-specific

Modes: BTS, MS

When the measurement is started the instrument automatically assumes the SINGLE mode.

An ongoing measurement can be aborted via the command `ABORT`. Further results of the phase/frequency error measurement can be then queried without restart of the measurement via the `:FETCh: BURSt`-subsystem.

This command is a query only and therefore has no *RST value assigned. It is available only if measurement of the phase/frequency error is selected (see `:CONFigure: BURSt: PFERror`).

:READ:BURSt:FERRor:STATus?

This command starts the measurement of the phase and frequency error of the base station or mobile and reads out the status of the frequency error taken over the selected number of bursts.

0: failed, 1: passed

Example: " :READ: BURS: FERR: STAT? "

Features: *RST value: --
 SCPI: device-specific

Modes: BTS, MS

When the measurement is started the instrument automatically assumes the SINGLE mode.

An ongoing measurement can be aborted via the command `ABORT`. Further results of the phase/frequency error measurement can be then queried without restart of the measurement via the `:FETCh: BURSt`-subsystem.

This command is a query only and therefore has no *RST value assigned. It is available only if measurement of the phase/frequency error is selected (see `:CONFigure: BURSt: PFERror`).

:READ:BURSt:FERRor:AVERage?

This command starts the measurement of the phase and frequency error of the base station or mobile and reads out the average of the frequency error taken over the selected number of bursts.

Example: " :READ: BURS: FERR: AVER? "

Features: *RST value: --
 SCPI: device-specific

Modes: BTS, MS

When the measurement is started the instrument automatically assumes the SINGLE mode.

An ongoing measurement can be aborted via the command `ABORT`. Further results of the phase/frequency error measurement can be then queried without restart of the measurement via the `:FETCh: BURSt`-subsystem.

This command is a query only and therefore has no *RST value assigned. It is available only if measurement of the phase/frequency error is selected (see `:CONFigure: BURSt: PFERror`).

:READ:BURSt:FERRor:MAXimum?

This command starts the measurement of the phase and frequency error of the base station or mobile and reads out the maximum of the frequency error for the selected number of bursts.

Example: " :READ:BURS:FERR:MAX? "

Features: *RST value: --
SCPI: device-specific

Modes: BTS, MS

When the measurement is started the instrument automatically assumes the SINGLE mode.

An ongoing measurement can be aborted via the command `ABORT`. Further results of the phase/frequency error measurement can be then queried without restart of the measurement via the `:FETCh:BURSt`-subsystem.

This command is a query only and therefore has no *RST value assigned. It is available only if measurement of the phase/frequency error is selected (see `:CONFigure:BURSt:PFERRor`).

:READ:BURSt:POWer?

Carrier Power measurement: (:CONFigure:MS:POWer:SINGLE:STATE OFF)

This command starts the measurement of the maximum output power of the base station or mobile and reads out the result.

Measurement of the maximum output power marks the beginning of a measurement cycle where subsequently the limits of the static and dynamic power control levels are checked step by step (`READ:BURSt:STATic?` or `READ:BURSt:DYNamic?`).

Parameter: The result is read out as an ASCII string in the following format:

```
<Static Power Ctrl>,<Dyn Power Ctrl>,<Rat-Level>,<Act-Level>,<Delta>,<Status>
```

<Static Power Ctrl>: 0
 <Dyn Power Ctrl>: 0
 <Rat-Level>: rated value for the current power control level acc. to standard in dBm
 <Act-Level>: measured power in dBm
 <Delta>: 0
 <Status>: result of limit check in character data form:
 PASSED no limits exceeded
 FAILED limit exceeded

Example: " :READ:BURS:POW? "
Result: 0,0,43,44.1,0,PASSED

Features: *RST value: --
SCPI: device-specific

Modes: BTS, MS

When the measurement is started any ongoing measurement cycle is aborted.

An ongoing measurement can be aborted with the command `ABORT`. This command is a query only and has therefore no *RST value assigned. It is available only when measurement of the maximum carrier power is selected (see `:CONFigure:BURSt:POWer`).

Carrier Power Individual Messung: (:CONFIgure:MS:POWer:SINGLe:STATe ON)

This command starts the measurement of the maximum output power of the base station or mobile and reads out the result. The power control level is preset (command :CONFIgure<1|2>[:MS]:POWer:LEVel <num_value>)

Parameter: The result is read out as an ASCII string in the following format: single measurements are retrieved:

<Static Power Ctrl>,<Dyn Power Ctrl>,<Rat-Level>,<Act-Level>,<RBW>,<Arfcn>,<CF>,<Attenuation>,<Number of bursts>,<Status>

- <Static Power Ctrl>: current static power control level
- <Dyn Power Ctrl>: current dynamic power control level
- <Rat-Level>: rated value for the current power control level acc. to standard in dBm
- <Act-Level>: measured power in dBm
- <RBW>: resolution bandwidth in kHz
- <ARFCN>: channel number
- <CF>: carrier frequency in Hz
- <Att>: external attenuation in dBm
- <Number of burst>: number of bursts
- <Status>: result of limit check in character data form:
 PASSED no limits exceeded
 FAILED limit exceeded

Example: " :READ:BURS:POW? "
 Result:: 0,3,37,20.6915,1000,2,8.904E+008,20,1,FAILED,
 0,3,37,20.3597,1000,2,8.904E+008,20,1,FAILED

Features: *RST value: --
 SCPI: device-specific

Modes: BTS, MS

When the measurement is started any ongoing measurement cycle is aborted.

An ongoing measurement can be aborted with the command ABORT. This command is a query only and has therefore no *RST value assigned. It is available only when measurement of the maximum carrier power is selected (see :CONFIgure:BURSt:POWer).

:READ:BURSt:POWer:STATic?

This command increases the static power control level for the measurement by one step, measures the output power of the base station and reads out the result.

If the command `READ:BURSt:POWer:STATic?` is repeated after the maximum static power control level is reached, the measurement sequence is terminated and the result of the maximum static power control level is read out again. In this case the value 'FINISHED' indicating the status is read out. Before the status value 'FINISHED' is read out, the value 'RUNNING' is output if the total result of the limit check is queried via `:CALCulate<1|2>:LIMit<1 to 8>:BURSt:POWer?`.

Parameter: The result is read out as an ASCII string in the following format:

<Static Power Ctrl>,<Dyn Power Ctrl>,<Rat-Level>,<Act-Level>,<Delta>,<Status>

<Static Power Ctrl>: current static power control level

<Dyn Power Ctrl>: current dynamic power control level

<Rat-Level>: rated value for the current power control level acc. to standard in dBm

<Act-Level>: measured power in dBm

<Delta>: difference between the measured power and the power at the previous static power control level.

<Status>: result of the limit check in character data form:

PASSED no limit exceeded

FAILED limit exceeded

FINISHED measurement sequence terminated

Example: " :READ:BURSt:POW:STAT? "

Result: 1,0,41,42.5,1.6,PASSED

Features: *RST value: --

SCPI: device-specific

Mode: BTS

The command `ABORt` terminates an ongoing measurement and resets the static and dynamic power control level to 0.

This command is only a query and therefore has no *RST value assigned. It is available only if measurement of the maximum carrier power is selected. (see `:CONFIgure:BURSt:POWer`).

:READ:BURSt:POWer:DYNamic?

This command increases the dynamic power control level for the measurement by one step, measures the output power of the base station and reads out the result.

Once the maximum dynamic power control level is reached the command is accepted only after the static power control level is increased by one step.

Note that the command is no longer accepted after the measurement sequence is terminated which implies that the static power control level was read out again with `READ:BURSt:POWer:STATic?` after the maximum value was reached and marked with the 'FINISHED' status.

Parameter: The result is read out as an ASCII string in the following format:

```
<Static Power Ctrl>,<Dyn Power Ctrl>,<Rat-Level>,<Act-Level>,<Delta>,<Status>
```

<Static Power Ctrl>: current static power control level
<Dyn Power Ctrl>: current dynamic power control level
<Rat-Level>: rated value for the current power control level acc. to standard in dBm
<Act-Level>: measured power in dBm
<Delta>: difference between the measured power and the power at the previous dynamic power control level.
<Status>: result of the limit check in character data form:
 PASSED no limit exceeded
 FAILED limit exceeded

Example: `" :READ:BURSt:POW:DYN?"`
 Result: `1,3,35,32.5,5.6,FAILED`

Features: *RST value: --
 SCPI: device-specific

Mode: BTS

The command `ABORT` terminates an ongoing measurement and resets the static and dynamic power control level to 0.

This command is only a query and therefore has no *RST value assigned. It is available only if measurement of the maximum carrier power is selected. (see `:CONFigure:BURSt:POWer`).

:READ:BURSt:POWer:LEVel?

This command increases the power control level for the measurement by one step, measures the output power of the mobile and reads out the result.

Note that the command is no longer accepted after the measurement sequence is terminated which implies that the power control level was read out again with `READ:BURSt:POWer:LEVel?` after the maximum value was reached and marked with the 'FINISHED' status.

Parameter: The result is read out as an ASCII string in the following format:

<0>, <Power Ctrl Level>,<Rat-Level>,<Act-Level>, <Delta>,<Status>

<0>: always 0

<Power Ctrl Level>: current power control level

<Rat-Level>: rated value for the current power control level acc.
to standard in dBm

<Act-Level>: measured power in dBm

<Delta>: difference between the measured power and the power
at the previous power control level.

<Status>: result of the limit check in character data form:
PASSED no limit exceeded
FAILED limit exceeded

Example: " :READ:BURSt:POW:LEV? "
Result: 0,3,35,32.5,5.6,FAILED

Features: *RST value: --
SCPI: device-specific

Mode: MS

The command `ABORt` terminates an ongoing measurement and resets the power control level to 0.

This command is only a query and therefore has no *RST value assigned. It is available only if measurement of the maximum carrier power is selected. (see `:CONFIgure:BURSt:POWer`).

:READ:BURSt:REFerence[:IMMediate]?

This command starts the premeasurement and as a result provides the measured level in dBm.

Example: " :READ:BURSt:REF? "

Feature: *RST value: --
SCPI: device-specific

Mode: MS, BTS

This is a query command only and therefore has no *RST value.

:READ:BURSt:MACCuracy:RMS:STATus?

This command starts the measurement of the modulation accuracy of the base station or mobile and reads out the status of the RMS-measurement taken over the selected number of bursts.

0: failed, 1: passed

Example: " :READ: BURS: MACC: RMS: STAT? "

Features: *RST value: --
SCPI: device-specific

Modes: BTS, MS

When the measurement is started the instrument automatically assumes the SINGLE mode.

An ongoing measurement can be aborted via the command `ABORT`. Further results of the modulation accuracy measurement can be then queried without restart of the measurement via the `:FETCh: BURSt`-subsystem.

This command is a query only and therefore has no *RST value assigned. It is available only if measurement of the modulation accuracy is selected (see `:CONFIgure: BURSt: MACCuracy`).

:READ:BURSt:MACCuracy:RMS:AVERAge?

This command starts the measurement of the modulation accuracy of the base station or mobile and reads out the average of the RMS-measurement taken over the selected number of bursts.

Example: " :READ: BURS: MACC: RMS: AVER? "

Features: *RST value: --
SCPI: device-specific

Modes: BTS, MS

When the measurement is started the instrument automatically assumes the SINGLE mode.

An ongoing measurement can be aborted via the command `ABORT`. Further results of the modulation accuracy measurement can be then queried without restart of the measurement via the `:FETCh: BURSt`-subsystem.

This command is a query only and therefore has no *RST value assigned. It is available only if measurement of the modulation accuracy is selected (see `:CONFIgure: BURSt: MACCuracy`).

:READ:BURSt:MACCuracy:RMS:MAXimum?

This command starts the measurement of the modulation accuracy of the base station or mobile and reads out the maximum of the RMS-measurement for the selected number of bursts.

Example: " :READ: BURS: MACC: RMS: MAX? "

Features: *RST value: --
SCPI: device-specific

Modes: BTS, MS

When the measurement is started the instrument automatically assumes the SINGLE mode.

An ongoing measurement can be aborted via the command `ABORT`. Further results of the modulation accuracy measurement can be then queried without restart of the measurement via the `:FETCh: BURSt`-subsystem.

This command is a query only and therefore has no *RST value assigned. It is available only if measurement of the modulation accuracy is selected (see `:CONFIgure: BURSt: MACCuracy`).

:READ:BURSt:MACCuracy:PEAK:STATus?

This command starts the measurement of the modulation accuracy of the base station or mobile and reads out the status of the PEAK-measurement taken over the selected number of bursts.

0: failed, 1: passed

Example: " :READ: BURS: MACC: PEAK: STAT? "

Features: *RST value: --
SCPI: device-specific

Modes: BTS, MS

When the measurement is started the instrument automatically assumes the SINGLE mode.

An ongoing measurement can be aborted via the command `ABORT`. Further results of the modulation accuracy measurement can be then queried without restart of the measurement via the `:FETCh: BURSt`-subsystem.

This command is a query only and therefore has no *RST value assigned. It is available only if measurement of the modulation accuracy is selected (see `:CONFigure: BURSt: MACCuracy`).

:READ:BURSt:MACCuracy:PEAK:AVERAge?

This command starts the measurement of the modulation accuracy of the base station or mobile and reads out the average of the PEAK-measurement taken over the selected number of bursts.

Example: " :READ: BURS: MACC: PEAK: AVER? "

Features: *RST value: --
SCPI: device-specific

Modes: BTS, MS

When the measurement is started the instrument automatically assumes the SINGLE mode.

An ongoing measurement can be aborted via the command `ABORT`. Further results of the modulation accuracy measurement can be then queried without restart of the measurement via the `:FETCh: BURSt`-subsystem.

This command is a query only and therefore has no *RST value assigned. It is available only if measurement of the modulation accuracy is selected (see `:CONFigure: BURSt: MACCuracy`).

:READ:BURSt:MACCuracy:PEAK:MAXimum?

This command starts the measurement of the modulation accuracy of the base station or mobile and reads out the maximum of the PEAK-measurement for the selected number of bursts.

Example: " :READ: BURS: MACC: PEAK: MAX? "

Features: *RST value: --
SCPI: device-specific

Modes: BTS, MS

When the measurement is started the instrument automatically assumes the SINGLE mode.

An ongoing measurement can be aborted via the command `ABORT`. Further results of the modulation accuracy measurement can be then queried without restart of the measurement via the `:FETCh: BURSt`-subsystem.

This command is a query only and therefore has no *RST value assigned. It is available only if measurement of the modulation accuracy is selected (see `:CONFigure: BURSt: MACCuracy`).

:READ:BURSt:MACCuracy:OSUPpress:STATus?

This command starts the measurement of the modulation accuracy of the base station or mobile and reads out the status of the original offset suppression measurement taken over the selected number of bursts.

0: failed, 1: passed

Example: " :READ: BURS: MACC: OSUP: STAT? "

Features: *RST value: --
SCPI: device-specific

Modes: BTS, MS

When the measurement is started the instrument automatically assumes the SINGLE mode.

An ongoing measurement can be aborted via the command `ABORT`. Further results of the modulation accuracy measurement can be then queried without restart of the measurement via the `:FETCh: BURSt`-subsystem. This command is a query only and therefore has no *RST value assigned. It is available only if measurement of the modulation accuracy is selected (see `:CONFIgure: BURSt: MACCuracy`).

:READ:BURSt:MACCuracy:OSUPpress:AVERAge?

This command starts the measurement of the modulation accuracy of the base station or mobile and reads out the average of the original offset suppression measurement taken over the selected number of bursts.

Example: " :READ: BURS: MACC: OSUP: AVER? "

Features: *RST value: --
SCPI: device-specific

Modes: BTS, MS

When the measurement is started the instrument automatically assumes the SINGLE mode.

An ongoing measurement can be aborted via the command `ABORT`. Further results of the modulation accuracy measurement can be then queried without restart of the measurement via the `:FETCh: BURSt`-subsystem. This command is a query only and therefore has no *RST value assigned. It is available only if measurement of the modulation accuracy is selected (see `:CONFIgure: BURSt: MACCuracy`).

:READ:BURSt:MACCuracy:OSUPpress:MAXimum?

This command starts the measurement of the modulation accuracy of the base station or mobile and reads out the maximum of the original offset suppression measurement for the selected number of bursts.

Example: " :READ: BURS: MACC: OSUP: MAX? "

Features: *RST value: --
SCPI: device-specific

Modes: BTS, MS

When the measurement is started the instrument automatically assumes the SINGLE mode.

An ongoing measurement can be aborted via the command `ABORT`. Further results of the modulation accuracy measurement can be then queried without restart of the measurement via the `:FETCh: BURSt`-subsystem. This command is a query only and therefore has no *RST value assigned. It is available only if measurement of the modulation accuracy is selected (see `:CONFIgure: BURSt: MACCuracy`).

:READ:BURSt:MACCuracy:PERCentile:STATus?

This command starts the measurement of the modulation accuracy of the base station or mobile and reads out the status of the 95% percentile measurement taken over the selected number of bursts.

0: failed, 1: passed

Example: " :READ: BURS: MACC: PERC: STAT? "

Features: *RST value: --
SCPI: device-specific

Modes: BTS, MS

When the measurement is started the instrument automatically assumes the SINGLE mode.

An ongoing measurement can be aborted via the command `ABORT`. Further results of the modulation accuracy measurement can be then queried without restart of the measurement via the `:FETCh: BURSt`-subsystem.

This command is a query only and therefore has no *RST value assigned. It is available only if measurement of the modulation accuracy is selected (see `:CONFIgure: BURSt: MACCuracy`).

:READ:BURSt:MACCuracy:PERCentile:AVERage?

This command starts the measurement of the modulation accuracy of the base station or mobile and reads out the average of the 95% percentile measurement taken over the selected number of bursts.

Example: " :READ: BURS: MACC: PERC: AVER? "

Features: *RST value: --
SCPI: device-specific

Modes: BTS, MS

When the measurement is started the instrument automatically assumes the SINGLE mode.

An ongoing measurement can be aborted via the command `ABORT`. Further results of the modulation accuracy measurement can be then queried without restart of the measurement via the `:FETCh: BURSt`-subsystem.

This command is a query only and therefore has no *RST value assigned. It is available only if measurement of the modulation accuracy is selected (see `:CONFIgure: BURSt: MACCuracy`).

:READ:BURSt:MACCuracy:PERCentile:MAXimum?

This command starts the measurement of the modulation accuracy of the base station or mobile and reads out the maximum of the 95% percentile measurement for the selected number of bursts.

Example: " :READ: BURS: MACC: PERC: MAX? "

Features: *RST value: --
SCPI: device-specific

Modes: BTS, MS

When the measurement is started the instrument automatically assumes the SINGLE mode.

An ongoing measurement can be aborted via the command `ABORT`. Further results of the modulation accuracy measurement can be then queried without restart of the measurement via the `:FETCh: BURSt`-subsystem.

This command is a query only and therefore has no *RST value assigned. It is available only if measurement of the modulation accuracy is selected (see `:CONFIgure: BURSt: MACCuracy`).

:READ:BURSt:MACCuracy:FREQuency:STATus?

This command starts the measurement of the modulation accuracy of the base station or mobile and reads out the status of the frequency error measurement taken over the selected number of bursts.

0: failed, 1: passed

Example: " :READ:BURS:MACC:FREQ:STAT? "

Features: *RST value: --
SCPI: device-specific

Modes: BTS, MS

When the measurement is started the instrument automatically assumes the SINGLE mode.

An ongoing measurement can be aborted via the command `ABORT`. Further results of the modulation accuracy measurement can be then queried without restart of the measurement via the `:FETCh:BURSt`-subsystem.

This command is a query only and therefore has no *RST value assigned. It is available only if measurement of the modulation accuracy is selected (see `:CONFIgure:BURSt:MACCuracy`).

:READ:BURSt:MACCuracy:FREQuency:AVERAge?

This command starts the measurement of the modulation accuracy of the base station or mobile and reads out the average of the frequency error measurement taken over the selected number of bursts.

Example: " :READ:BURS:MACC:FREQ:AVER? "

Features: *RST value: --
SCPI: device-specific

Modes: BTS, MS

When the measurement is started the instrument automatically assumes the SINGLE mode.

An ongoing measurement can be aborted via the command `ABORT`. Further results of the modulation accuracy measurement can be then queried without restart of the measurement via the `:FETCh:BURSt`-subsystem.

This command is a query only and therefore has no *RST value assigned. It is available only if measurement of the modulation accuracy is selected (see `:CONFIgure:BURSt:MACCuracy`).

:READ:BURSt:MACCuracy:FREQuency:MAXimum?

This command starts the measurement of the modulation accuracy of the base station or mobile and reads out the maximum of the frequency error measurement for the selected number of bursts.

Example: " :READ:BURS:MACC:FREQ:MAX? "

Features: *RST value: --
SCPI: device-specific

Modes: BTS, MS

When the measurement is started the instrument automatically assumes the SINGLE mode.

An ongoing measurement can be aborted via the command `ABORT`. Further results of the modulation accuracy measurement can be then queried without restart of the measurement via the `:FETCh:BURSt`-subsystem.

This command is a query only and therefore has no *RST value assigned. It is available only if measurement of the modulation accuracy is selected (see `:CONFIgure:BURSt:MACCuracy`).

READ:SPECTrum Subsystem

This subsystem provides the commands for starting measurements in the GSM BTS (option FSE-K11) and GSM MS (option FSE-K10) Analyzer mode, which are used to measure the power of the spectral components due to modulation and switching (modulation spectrum, transient spectrum), and for reading out the results subsequently.

| COMMAND | PARAMETERS | UNIT | COMMENT |
|------------------------|------------|------|---------------------------|
| READ | | | |
| :SPECTrum | | | Option FSE-K11 or FSE-K10 |
| :MODulation [:ALL]? | -- | | query only |
| :SWITching [:ALL]? | -- | | query only |

:READ:SPECTrum:MODulation[:ALL]?

This command starts the measurement of the modulation spectrum of the base station or mobile and reads out the result. The measurement is performed in the currently set frequency range.

Parameter: The result is read out as a list of partial ASCII result strings separated by ',' in the following format:

```
<Index>,<Freq1>,<Freq2>,<Level>,<Limit>, <Abs/Rel>,<Status> [,
<Index>,<Freq1>,<Freq2>,<Level>,<Limit>, <Abs/Rel>,<Status>]...
```

where the part set in '['...] characterizes a partial result string which can be repeated n times.

<Index>: 0, if the partial result string characterizes a measurement range.
 current number <>0, if the partial result string characterizes a single limit excess.

<Freq1>: Start frequency of the measurement range or frequency where the limit is exceeded.

<Freq2>: Stop frequency of the measurement range or frequency where the measured range is exceeded. The value of <Freq2> is equal to the value of <Freq1>, if either the measurement is performed in the time domain or the partial result string contains a limit excess.

<Level>: Measured maximum level of the partial range or measured level at the test point.

<Limit>: Limit in the partial range or at the test point.

<Abs/Rel>: ABS <Level> and <Limit> are in absolute units (dBm)
 REL <Level> and <Limit> are in relative units (dB)

<Status>: Result of the limit check in character data form:
 PASSED no limit exceeded
 FAILED limit exceeded
 MARGIN margin exceeded
 EXC limited excess characterized as an exception

The frequencies <Freq1> and <Freq2> are always absolute and not referred to the carrier frequency.

Example: ":READ:SPEC:MOD?"
Result: 0,890E6,915E6,-87.4,-108.0,ABS,FAILED,
 1,893.2E6,893.2E6,-83.2,-108.0,ABS,FAILED,
 2,895.7E6,895.7E6,-87.4,-108.0,ABS,FAILED

Features: *RST value: --
 SCPI: device-specific

Modes: BTS, MS

The command `ABORT` aborts an ongoing measurement.

This command is only a query and therefore has no *RST value assigned. It is available only if measurement of the modulation spectrum is selected. (see `:CONFigure:SPECTrum:MODulation`).

:READ:SPECTrum:SWITching[:ALL]?

This command starts the measurement of the transient spectrum of the base station or mobile and reads out the result.

Parameter: The result is read out as a list of partial ASCII result strings separated by ',' in the format used for `READ:SPECTrum:MODulation[:ALL]?`.

Example: ":READ:SPEC:SWIT?"
Result: 0,833.4E6,833.4E6,37.4,-36.0,ABS,MARGIN,
 1,834.0E6,834.0E6,-35.2,-36.0,ABS,FAILED,
 2,834.6E6,834.6E6,-74.3,-75.0,REL,FAILED
 0,835.0E6,835.0E6,-65,0,-60.0,REL,PASSED

Features: *RST value: --
 SCPI: device-specific

Modes: BTS, MS

The command `ABORT` aborts an ongoing measurement.

This command is only a query and therefore has no *RST value assigned. It is available only if measurement of the transient spectrum is selected. (see `:CONFigure:SPECTrum:SWITChing`).

READ:SPURious Subsystem

This subsystem provides the commands for starting measurements in the GSM BTS (option FSE-K11) and GSM MS (option FSE-K10) Analyzer mode, which are used to measure the power of spurious emissions, and for reading out the results subsequently.

| COMMAND | PARAMETERS | UNIT | COMMENT |
|--|------------|------|---|
| READ :SPURious [:ALL]? :STEP? | | | Option FSE-K11 or FSE-K10 query only query only |

:READ:SPURious[:ALL]?

This command starts the measurement of the spurious emissions of the base station or mobile and reads out the result. The measurement is performed in the currently set frequency range.

Parameter: The result is read out as a list of partial ASCII result strings separated by ',' in the following format:

```
<Index>,<Freq1>,<Freq2>,<Level>,<Limit>,<Abs/Rel>,<Status> [,
<Index>,<Freq1>,<Freq2>,<Level>,<Limit>,<Abs/Rel>,<Status>]...
```

where the part set in '['...]' characterizes a partial result string which can be repeated n times.

```
<Index>:      0,                if the partial result string characterizes a
                current number <>0,
                if the partial result string characterizes a
                single limit excess.
<Freq1>:      Start frequency of the measurement range or frequency where
                the limit is exceeded.
<Freq2>:      Stop frequency of the measurement range or frequency where
                the measured range is exceeded. The value of <Freq2> is
                equal to the value of <Freq1>, if either the measurement is
                performed in the time domain or the partial result string contains
                a limit excess.
<Level>:      Measured maximum level of the partial range or measured level
                at the test point.
<Limit>:      Limit in the partial range or at the test point.
<Abs/Rel>:    ABS <Level> and <Limit> are in absolute units (dBm)
                REL <Level> and <Limit> are in absolute units (dBm)
<Status>:     Result of the limit check in character data form:
                PASSED      no limit exceeded
                FAILED      limit exceeded
                MARGIN      margin exceeded
```

Example: " :READ:SPUR? "
 Result: 0,890E6,915E6,-87.4,-108.0,ABS,FAILED,
 1,893.2E6,893.2E6,-83.2,-108.0,ABS,FAILED,
 2,895.7E6,895.7E6,-87.4,-108.0,ABS,FAILED

SENSe Subsystem

The SENSe subsystem is itself divided up into several subsystems. The commands of these subsystems directly control device-specific settings, they do not refer to the signal characteristics of the measurement signal.

The SENSe subsystem controls the essential parameters of the analyzer and vector analyzer. In accordance with the SCPI standard, it is for this reason optional, which means that it is not necessary to include the SENSe node in command sequences.

In the split-screen representation, a distinction is made between SENSe1 and SENSe2:

SENSe1 $\hat{=}$ screen A;

SENSe2 $\hat{=}$ screen B

SENSe:ADEMod Subsystem

This subsystem controls the parameters for analog demodulation. It is active only in conjunction with option Vector Signal Analysis, FSE-B7.

| COMMAND | PARAMETERS | UNIT | COMMENT |
|---|--|------|------------------------|
| [SENSe<1 2>] :ADEMod :AF :COUPling :SQUelch [:STATe] :LEVel :SBANd :RTIMe | AC DC <Boolean> <numeric_value> NORMal INVerse <Boolean> | DBM | Vector Signal Analysis |

:[SENSe<1|2>]:ADEMod:AF:COUPling AC | DC

This command selects coupling of the AF-branch.

Example: " :ADEM:AF:COUP DC "

Features: *RST value: AC
SCPI: device-specific

Mode: VA-A

:[SENSe<1|2>]:ADEMod:SQUelch[:STATe] ON | OFF

This command switches the squelch for the audio branch on or off.

Example: " :ADEM:SQU ON "

Features: *RST value: OFF
SCPI: device-specific

Mode: VA-A

:[SENSe<1|2>:]ADEMod:SQUelch:LEVel 30 to -150 dBm

This command defines the switching threshold for the squelch referred to the measured signal.

Example: " :ADEM:SQU -10DBM "

Features: *RST value: -40dBm
SCPI: device-specific

Mode: VA-A

:[SENSe<1|2>:]ADEMod:SBANd NORMAl | INVerse

This command selects the side band for the demodulation.

Example: " :ADEM:SBAN INV "

Features: *RST value: NORMAl
SCPI: device-specific

Mode: VA-A

:[SENSe<1|2>:]ADEMod:RTIME ON | OFF

This command selects whether the demodulation performed in real time or in blocks.

Example: " :ADEM:RTIM ON "

Features: *RST value: ON
SCPI: device-specific

Mode: VA-A

SENSe:AVERage Subsystem

The SENSe:AVERage subsystem calculates the average of the data acquired. A new test result is obtained from various successive measurements. The amount of test points and the axis reference of the new result correspond to those of the original measurements.

| COMMAND | PARAMETERS | UNIT | COMMENT |
|--|---|----------------------|---------|
| [SENSe<1 2>] :AVERage :COUNT :AUTO [:STATe] :TYPE | <numeric_value> <Boolean> <Boolean> MAXimum SCALar | -- -- -- -- | |

:[SENSe<1|2>:]AVERage:COUNT 0 to 32767

The command specifies the number of measurements which are combined.

Example: " :AVER:COUN 16 "

Features: *RST value: 0
SCPI: conforming

Modes: A. VA-D

:[SENSe<1|2>:]AVERage:COUNT:AUTO ON | OFF

AUTO ON selects a suitable number of :COUNT for the respective type of measurement.

Example: " :AVER:COUN:AUTO ON "

Features: *RST value: OFF
SCPI: conforming

Modes: A. VA-D

:[SENSe<1|2>:]AVERage[:STATe] ON | OFF

The command switches on or off the average function.

Example: "AVER OFF"

Features: *RST value: OFF
SCPI: conforming

Modes: A, VA, BTS, MS

:**[SENSe<1|2>:]AVERAge:TYPE** MAXimum | MINimum | SCALar

The command selects the type of average function.

Example: " :AVER:TYPE SCAL "

Features: *RST value: SCALar
SCPI: conforming

Modes: A, VA, BTS, MS

The following average functions have been defined:

MAXimum (MAX HOLD): $AVG(n) = MAX(X_1 \text{ to } .X_n)$

MINimum (MIN HOLD): $AVG(n) = Min(X_1 \text{ to } .X_n)$

SCALar (AVERAGE): $AVG(n) = \frac{1}{n} \times \sum_{i=1}^n x_i$

SENSe:BANDwidth Subsystem

This subsystem controls the setting of the instrument's filter bandwidths. Both groups of commands (BANDwidth and BWIDth) perform the same functions.

| COMMAND | PARAMETERS | UNIT | COMMENT |
|--|--|--|---|
| [SENSe<1 2>] :BANDwidth :BWIDth [:RESolution] :AUTO :MODE :FFT :RATio :VIDeo :AUTO :RATio :DEMod :PLL | <numeric_value> <Boolean> ANALog DIGital <Boolean> <numeric_value> <numeric_value> <Boolean> <numeric_value> SINE PULSe NOISe <numeric_value> AUTO HIGH MEDium LOW | HZ -- -- -- -- HZ -- -- HZ -- | option FFT Filter Vector Signal Analysis |

:[SENSe<1|2>]:BANDwidth|BWIDth[:RESolution] <numeric_value>

This command defines the analyzer's resolution bandwidth.

Example: " :BAND 1MHz "

Features: *RST value: - (AUTO is set to ON)
SCPI: conforming

Modes: A, VA, BTS, MS

The values for the resolution bandwidth are rounded in 1 | 2 | 3 | 5 steps.

In the GSM BTS/MS ANALYZER mode with option FSE-K11/K10, the command is available for POWER vs. TIME measurement. In this case, the parameters DEFault (bandwidth setting according to GSM standard), 300KHZ and 1MHZ are permitted.

:[SENSe<1|2>:]BANDwidth|BWIDth[:RESolution]:AUTO ON | OFF

This command either automatically couples the resolution bandwidth of the instrument to the span or cancels the coupling.

Example: " :BAND:AUTO OFF "

Features: *RST value: ON
SCPI: conforming

Modes: A, VA

The automatic coupling matches the resolution bandwidth to the currently set span according to the relationship between span and resolution bandwidth.

:[SENSe<1|2>:]BANDwidth|BWIDth[:RESolution]:MODE ANALog | DIGital

This command toggles between analog and digital resolution filters for the 1-kHz bandwidth.

Example: " :BAND:MODE DIG "

Features: *RST value: ANALog
SCPI: device-specific

Mode: A

Depending on the bandwidth, the resolution filters are automatically toggled between digital filters (<1kHz) and analog filters (>1kHz). The 1-kHz bandwidth is present in the instrument as a digital filter and as an analog filter and can be toggled using this command. If the analog filter is selected for the bandwidth 1kHz, the FFT-filtering for bandwidths \leq 1kHz is switched off.

:[SENSe<1|2>:]BANDwidth|BWIDth[:RESolution]:MODE:FFT ON | OFF

This command toggles the digital filters used for bandwidths \leq 1 kHz between ordinary mode and FFT-filter mode.

Example: " :BAND:MODE:FFT ON "

Features: *RST value: OFF
SCPI: device-specific

Mode: A

The filter bandwidth of 1 kHz is switched to digital filtering for both ON and OFF.

This command is only available in conjunction with option FFT Filter.

:[SENSe<1|2>:]BANDwidth|BWIDth[:RESolution]:RATio 0.0001 to 1

This command defines the ratio resolution bandwidth (Hz) / span (Hz).

Example: " :BAND:RAT 0.1 "

Features: *RST value: -- (AUTO is set to ON)
SCPI: conforming

Modes: A, VA, R

The ratio to be entered is reciprocal to the ratio Span/RBW used in manual control.

:[SENSe<1|2>:]BANDwidth|BWIDth:VIDeo 1Hz to 10MHz

This command defines the instrument's video bandwidth.

Example: " :BAND:VID 10kHz "

Features: *RST value: - (AUTO is set to ON)
SCPI: conforming

Mode: A

The values for the video bandwidth are rounded in 1 | 2 | 3 | 5 steps.

:[SENSe<1|2>:]BANDwidth|BWIDth:VIDeo:AUTO ON | OFF

This command either automatically couples the instrument's video bandwidth to the resolution bandwidth or cancels the coupling.

Example: " :BAND:VID:AUTO OFF "

Features: *RST value: ON
SCPI: conforming

Mode: A

:[SENSe<1|2>:]BANDwidth|BWIDth:VIDeo:RATIO 0.001to 1000 | SINE | PULSE | NOISE

This command defines the ratio video bandwidth (Hz) / resolution bandwidth (Hz).

Parameter: The parameters SINE, PULSE and NOISE may be used as synonyms for the following values:

SINE: 1
PULSE: 10
NOISE: 0.1

Example: " :BAND:VID:RAT 10 "

Features: *RST value: - (AUTO is set to ON)
SCPI: conforming

Modes: A, VA

The ratio to be entered is reciprocal to the ratio RBW/VBW used in manual control.

:[SENSe<1|2>:]BANDwidth|BWIDth:DEMod

5kHz to 200kHz (Real Time on) | 5kHz to 5MHz (Real Time off)

This command defines the demodulation bandwidth of the instrument for analog demodulation.

Example: " :BAND:DEM 100KHZ "

Features: *RST value: 100KHZ
SCPI: device-specific

Mode: VA-A

The values for the demodulation bandwidth are rounded in steps of 1 | 2 | 3 | 5.

:[SENSe<1|2>:]BANDwidth|BWIDth:PLL AUTO | HIGH | MEDium | LOW

This command defines the bandwidth of the main PLL of the instrument synthesizer.

Example: " :BAND:PLL HIGH "

Features: *RST value: AUTO
SCPI: device-specific

Mode: A

SENSe:CORRection-Subsystem

The SENSe:CORRection-subsystem controls the correction of measured results by means of frequency-dependent correction factors (e. g. for antenna or cable attenuation).

It also controls calibration and normalization during operation with the option Tracking Generator .

| COMMAND | PARAMETERS | UNIT | COMMENT |
|-----------------------------|-----------------------------|------------|------------------------------|
| [SENSe<1 2>] :CORRection | | | option Tracking Generator |
| :METHod | TRANsmission REFLexion | | |
| :COLLect | | | |
| [ACQuire] | THRough OPEN | | no query |
| [:STATe] | <Boolean> | | |
| :RECall | | | no query |
| :TRANsducer | | | |
| :CATalog? | | | query only |
| :ACTive? | | | query only |
| :SELect | <name> | | |
| :UNIT | <string> | | |
| :SCALing | LINear LOGarithmic | | |
| :COMMeNT | <string> | | |
| :DATA | <freq> , <level> .. | HZ , -- | |
| [:STATe] | <Boolean> | | |
| :DELete | -- | -- | no query |
| :TSET | | | |
| :CATalog? | | | query only |
| :ACTive? | | | query only |
| :SELect | <name> | | |
| :UNIT | <string> | | |
| :BReak | <Boolean> | | |
| :COMMeNT | <string> | | |
| :RANGe<1 to 10> | <freq> , <freq> , <name> .. | HZ, HZ, -- | |
| [:STATe] | <Boolean> | | |
| :DELete | -- | -- | no query |
| :LOSS | | | option FSE-K11 or FSE-K10 |
| :INPut | | | |
| [:MAGNitude] | <numeric_value> | DB | |
| :RXGain | | | option FSE-K11 or FSE-K10 |
| :INPut | | | |
| [:MAGNitude] | <numeric_value> | DB | |
| :CVL | | | option external mixer output |
| :CATalog? | | | query only |
| :SELect | <file_name> | | |
| :MIXer | <string> | | |
| :SNUMber | <string> | | |
| :BAND | A Q U V E W F D G Y J | | |
| :TYPE | ODD EVEN EODD | | |
| :PORTs | 2 3 | | |
| :BIAS | <numeric_value> | A | |
| :COMMeNT | <string> | | |
| :DATA | <freq> , <level> .. | HZ , DB | |
| :CLear | -- | -- | no query |

:[SENSe<1|2>:]CORRection[:STATe] ON | OFF

This command activates/deactivates normalization of the measurement results.

Example: " :CORR ON "

Features: *RST value: OFF
SCPI: conforming

Mode: A

This command is only valid in conjunction with option Tracking Generator.

:[SENSe<1|2>:]CORRection:METHod TRANsmission | REFLExion

This command selects the kind of measurement with active tracking generator (transmission/reflexion).

Example: " :CORR:METH TRAN "

Features: *RST value: TRANsmission
SCPI: device specific

Mode: A

This command is only valid in conjunction with option Tracking Generator.

:[SENSe<1|2>:]CORRection:COLLect[:ACQuire] THRough | OPEN

This command selects the kind of measurement for the reference values of the normalization (response calibration).

Example: " :CORR:COLL THR "

Features: *RST value:
SCPI: conforming

Mode: A

THRough "TRANsmission" mode: calibration with direct connection between tracking generator and device input.

"REFLExion" mode: calibration with short circuit at the input

OPEN only valid in "REFLExion" mode:calibration with open input

This command is an event which is why it is not assigned an *RST value an a query. It is only valid in conjunction with option Tracking Generator.

:[SENSe<1|2>:]CORRection:RECall

This command restores the instrument setting that was valid for the measurement of the reference data.

Example: " :CORR:REC "

Features: *RST value: -
SCPI: conforming

Mode: A

This command is an event which is why it is not assigned an *RST value and a query. It is only valid in conjunction with option Tracking Generator.

:[SENSe<1|2>:]CORRection:TRANsducer:CATalog?

This command reads out the names of all transducer factors stored on the harddisk.

Syntax of output format:

<Sum of file lengths of all subsequent files>,<free memory on hard disk>,
<1st file name>,,<1st file length>,<2nd file name>,,<2nd file length>,,...,<nth file name>,
<nth file length>

Example: " : CORR : TRAN : CAT ? "

Feature: *RST value: -
SCPI: device-specific

Mode: A

:[SENSe<1|2>:]CORRection:TRANsducer:ACTive?

This command reveals the active transducer factor. If no transducer factor is switched on, a void string will be output.

Example: " : CORR : TRAN : ACT ? "

Feature: *RST value: -
SCPI: device-specific

Mode: A

:[SENSe<1|2>:]CORRection:TRANsducer:SELEct <name>

This command selects the transducer factor designated by <name>. If <name> does not exist yet, a new transducer factor is created.

Parameter: <name>::= Name of the transducer factor in string data form with a maximum of 8 characters.

Example: " : CORR : TRAN : SEL 'FACTOR1' "

Features: *RST value: -
SCPI: device-specific

Mode: A

This command must be sent prior to the subsequent commands for modifying/activating transducer factors.

:[SENSe<1|2>:]CORRection:TRANsducer:UNIT <string>

This command defines the unit of the transducer factor selected.

Parameter: <string>::= 'DB' | 'DBM' | 'DBMV' | 'DBUV' | 'DBUV/M' | 'DBUA' | 'DBUA/M' | 'DBPW' | 'DBPT'

Example: " : CORR : TRAN : UNIT 'DBUV' "

Features: *RST value: 'DB'
SCPI: device-specific

Mode: A

Prior to this command, the command SENS : CORR : TRAN : SEL must be sent.

:[SENSe<1|2>:]CORRection:TRANsducer:SCALing LINear | LOGarithmic

This command defines whether the frequency scaling of the transducer factor is linear or logarithmic.

Example: " :CORR:TRAN:SCAL LOG "

Features: *RST value: LINear
SCPI: device-specific

Mode: A

Prior to this command, the command SENS:CORR:TRAN:SEL must be sent.

:[SENSe<1|2>:]CORRection:TRANsducer:COMMeNT <string>

This command defines the comment for the selected transducer factor.

Example: " :CORR:TRAN:COMM 'FACTOR FOR ANTENNA' "

Features: *RST value " (empty comment)
SCPI: device specific

Mode: A

Prior to this command, the command SENS:CORR:TRAN:SEL must be sent.

:[SENSe<1|2>:]CORRection:TRANsducer:DATA <freq>,<level>..

This command defines the test points for the selected transducer factor. The values are entered as a series of frequency/level pairs. The frequencies must be in ascending order.

Example: " :CORR:TRAN:TRANsducer:DATA 1MHZ,-30,2MHZ,-40 "

Features: *RST value: -
SCPI: device-specific

Mode: A

Prior to this command, the command SENS:CORR:TRAN:SEL must be sent. The level values are sent as dimensionless numbers; the unit is specified by means of the command SENS:CORR:TRAN:UNIT.

:[SENSe<1|2>:]CORRection:TRANsducer[:STATe] ON | OFF

This command switches the selected transducer factor on or off.

Example: " :CORR:TRAN ON "

Features: *RST value: OFF
SCPI: device-specific

Mode: A

Prior to this command, the command SENS:CORR:TRAN:SEL must be sent.

:[SENSe<1|2>:]CORRection:TRANsducer:DELeTe

This command deletes the selected transducer factor.

Example: " : CORR : TRAN : DEL "

Features: *RST value: -
SCPI: device-specific

Mode: A

This command is an event and therefore has no *RST value.

Prior to this command, the command SENS : CORR : TRAN : SEL must be sent.

:[SENSe<1|2>:]CORRection:TSET:CATalog?

This command polls the names of all transducer factors stored on the harddisk.

Syntax of output format:

<Sum of file lengths of all subsequent files>,<free memory on hard disk>,
<1st file name>,,<1st file length>,<2nd file name>,,<2nd file length>,.....,<nth file name>,
<nth file length>

Example: " : CORR : TSET : CAT? "

Mode: A

Feature: *RST value: -
SCPI: device-specific

:[SENSe<1|2>:]CORRection:TSET:ACTive?

This command reveals the active transducer set. If no transducer set is switched on, a void string will be output.

Example: " : CORR : TSET : ACT? "

Feature: *RST value: -
SCPI: device-specific

Mode: A

:[SENSe<1|2>:]CORRection:TSET:SELEct <name>

This command selected the transducer set designated by <name>. If <name> does not exist yet, a new set is created.

Parameter: <name>::= name of the transducer set in string data form with a maximum of 8 characters.

Example: " : CORR : TSET : SEL 'SET1' "

Features: *RST value: -
SCPI: device-specific

Mode: A

This command must be sent prior to the subsequent commands for changing/activating the transducer sets.

:[SENSe<1|2>:]CORRection:TSET:UNIT 'DB' | 'DBM' | 'DBUV' | 'DBUV/M' | 'DBUA' | 'DBUA/M' | 'DBPW' | 'DBPT'

This command defines the unit of the selected transducer sets. When assigning transducer factors to the set, only factors which are compatible to the selected unit, i. e. factors with the same unit or the unit dB, are allowed.

Example: " :CORR:TSET:UNIT 'DBUV' "

Features: *RST value: 'DB'
SCPI: device-specific

Mode: A

Prior to this command, the command `SENS:CORR:TSET:SEL` must be sent.

:[SENSe<1|2>:]CORRection:TSET:BReak ON | OFF

This command defines if the sweep is to be stopped on changeover from range to another.

Example: " :CORR:TSET:BR E ON "

Features: *RST value: OFF
SCPI: device-specific

Mode: A

Prior to the above command, the command `SENS:CORR:TSET:SEL` must be sent.

:[SENSe<1|2>:]CORRection:TSET:COMMeNT <string>

This command defines the comment for the selected transducer set.

Example: " :CORR:TSET:COMM 'SET FOR ANTENNA' "

Features: *RST value " (empty comment)
SCPI: device specific

Mode: A

Prior to this command, the command `SENS:CORR:TSET:SEL` must be sent.

:[SENSe<1|2>:]CORRection:TSET:RANGe<1 to 10> <freq>,<freq>,<name>..

This command defines a partial range of the selected transducer set. The partial range is determined by its start and stop frequencies plus a list of names of the assigned transducer factors. The ranges 1 to 10 must be sent in ascending order.

Parameter: <freq>,<freq>::= start frequency, stop frequency of the range
<name>...::= list of names for the assigned transducer factors.
The individual names must be characterized by single quotation marks (') and separated by commas.

Example: " :CORR:TRAN:TSET:RANG 1MHZ,2MHZ,'FACTOR1','FACTOR2' "

Features: *RST value: -
SCPI: device-specific

Mode: A

Prior to this command, the command `SENS:CORR:TSET:SEL` must be sent.

:[SENSe<1|2>:]CORRection:TSET[:STATe] ON | OFF

This command switches the selected transducer set on or off.

Example: " :CORR:TSET ON "

Features: *RST value: OFF
SCPI: device-specific

Mode: A

Prior to this command, the command SENS:CORR:TSET:SEL must be sent.

:[SENSe<1|2>:]CORRection:TSET:DELeTe

This command deletes the selected transducer set.

Example: " :CORR:TSET:DEL "

Features: *RST value: -
SCPI: device-specific

Mode: A

This command is an event and thus has no *RST value assigned.

Prior to this command, the command SENS:CORR:TSET:SEL must be sent.

:[SENSe<1|2>:]CORRection:LOSS:INPut[:MAGNitude] <numeric_value>

This command announces to the instrument a possibly needed external attenuation of the input signal, so that it is taken into account later when the level is set.

Parameter: <numeric_value>::= value of external attenuation in dB.

Example: " :CORR:LOSS:INP 30DB "

Features: *RST value: 20dB
SCPI: device-specific

Modes: BTS, MS

The external attenuation must be selected such that the input power of the analyzer does not exceed 27 dBm.

:[SENSe<1|2>:]CORRection:RXGain:INPut[:MAGNitude] <numeric_value>

This command announces to the instrument a possibly needed preamplification in the RX-band (RX BAND GAIN), so that it is taken into account later when the measured values are read out.

Parameter: <numeric_value>::= value of the amplification in dB.

Example: " :CORR:RXG:INP 30DB "

Features: *RST value: 0 dB
SCPI: device-specific

Modes: BTS, MS

:[SENSe<1|2>:]CORRection:CVL:CATalog?

This command polls the names of all conversion-loss tables stored on the harddisk.

Syntax of output format:

<Sum of file lengths of all subsequent files>,<free memory on hard disk>,
<1st file name>,,<1st file length>,<2nd file name>,,<2nd file length>,,...,<nth file name>,
<nth file length>

Example: " : CORR : CVL : CAT ? "

Feature: *RST value: -
SCPI: device-specific

Mode: A

This command is only valid in conjunction with option External Mixer Output, FSE-B21.

:[SENSe<1|2>:]CORRection:CVL:SElect <file_name>

This command selects the Conversion Loss Table designated with <file_name>. If <file_name> is not available, a new Conversion Loss Table will be created.

Parameter: <file_name>::= Name of Conversion Loss Table as string data with
a maximum of 8 characters

Example: " : CORR : CVL : SEL ' LOSS_TAB ' "

Features: *RST value: -
SCPI: device-specific

Mode: A

This command must be sent prior to the subsequent commands used to change/activate the Conversion Loss files. It is only valid in conjunction with option External Mixer Output, FSE-B21.

:[SENSe<1|2>:]CORRection:CVL:MIXer <string>

This command defines the type designation of the mixer in the Conversion Loss Table.

Parameter: <string>::= Type designation of mixer with a maximum of 16 characters

Example: " : CORR : CVL : MIX ' FSE_Z60 ' "

Features: *RST value: -
SCPI: device-specific

Mode: A

Command `SENS:CORR:CVL:SEL` must be sent prior to this command. This command is only valid in conjunction with option External Mixer Output, FSE-B21.

:[SENSe<1|2>:]CORRection:CVL:SNUMber <string>

This command defines the serial number of the mixer in the Conversion Loss Table.

Parameter: <string>:= Serial number of mixer with a maximum of 16 characters

Example: " :CORR:CVL:SNUM '123.4567' "

Features: *RST value: -
SCPI: device-specific

Mode: A

Command `SENS:CORR:CVL:SEL` must be sent prior to this command. This command is only valid in conjunction with option External Mixer Output, FSE-B21.

:[SENSe<1|2>:]CORRection:CVL:BAND A|Q|U|V|E|W|F|D|G|Y|J

This command defines the waveguide band in the Conversion Loss Table.

Example: " :CORR:CVL:BAND E "

Features: *RST value: -
SCPI: device-specific

Mode: A

Command `SENS:CORR:CVL:SEL` must be sent prior to this command. This command is only valid in conjunction with option External Mixer Output, FSE-B21.

:[SENSe<1|2>:]CORRection:CVL:TYPE ODD | EVEN | EODD

This command defines the type of harmonic in the Conversion Loss Table.

Example: " :CORR:CVL:TYPE EODD "

Features: *RST value: -
SCPI: device-specific

Mode: A

Command `SENS:CORR:CVL:SEL` must be sent prior to this command. This command is only valid in conjunction with option External Mixer Output, FSE-B21.

:[SENSe<1|2>:]CORRection:CVL:PORTs 2 | 3

This command defines the type of mixer in the Conversion Loss Table.

Example: " :CORR:CVL:PORT 3 "

Features: *RST value: -
SCPI: device-specific

Mode: A

Command `SENS:CORR:CVL:SEL` must be sent prior to this command. This command is only valid in conjunction with option External Mixer Output, FSE-B21.

:[SENSe<1|2>:]CORRection:CVL:BIAS <numeric_value>

This command defines the bias current in the Conversion Loss Table.

Example: " :CORR:CVL:BIAS 7mA"

Features: *RST value: -
SCPI: device-specific

Mode: A

Command `SENS:CORR:CVL:SEL` must be sent prior to this command. This command is only valid in conjunction with option External Mixer Output, FSE-B21.

:[SENSe<1|2>:]CORRection:CVL:COMMeNT <string>

This command defines the comment in the Conversion Loss Table.

Parameter: <string>:= Comment of mixer with a maximum of 60 characters

Example: " :CORR:CVL:COMMENT 'MIXER FOR BAND U' "

Features: *RST value: -
SCPI: device-specific

Mode: A

Command `SENS:CORR:CVL:SEL` must be sent prior to this command. This command is only valid in conjunction with option External Mixer Output, FSE-B21.

:[SENSe<1|2>:]CORRection:CVL:DATA <freq>,<level>..

This command defines the reference values of the selected Conversion Loss Tables. The values are entered as a result of frequency/level pairs. The frequencies have to be sent in ascending order.

Example: " :CORR:CVL:DATA 1MHZ,-30DB,2MHZ,-40DB"

Features: *RST value: -
SCPI: device-specific

Mode: A

Command `SENS:CORR:CVL:SEL` must be sent prior to this command. This command is only valid in conjunction with option External Mixer Output, FSE-B21.

:[SENSe<1|2>:]CORRection:CVL:CLEAr

This command deletes the selected Conversion Loss Table.

Example: " :CORR:CVL:CLE "

Features: *RST value: -
SCPI: device-specific

Mode: A

This command is an event which is why it is not assigned an *RST value.

Command `SENS:CORR:CVL:SEL` must be sent prior to this command. This command is only valid in conjunction with option External Mixer Output, FSE-B21.

SENSe:DETECTOR Subsystem

The SENSe:DETECTOR subsystem controls the recording of measurement values via the type of detector selected for each trace.

The suffix in SENSe<1|2> is not significant in this subsystem.

| COMMAND | PARAMETERS | UNIT | COMMENT |
|---|--|------|---------|
| [SENSe<1 2>] :DETECTOR<1to4> [:FUNCTION] :AUTO | APEak NEGative POSitive SAMPlE RMS AVERage <Boolean> | -- | |

:[SENSe<1|2>]:DETECTOR<1 to 4>[:FUNCTION] APEak | NEGative | POSitive | SAMPlE | RMS | AVERage

This command switches the detector for recording of the measured value.

Example: " :DET POS "

Features: *RST value: APEak
SCPI: conforming

Mode: A

The value "APEak" (AutoPeak) displays both the positive peak value and the negative peak value when noise is present. The positive peak value is displayed when one signal is present. The trace is selected by means of the numeric suffix after DETECTOR.

:[SENSe<1|2>]:DETECTOR<1 to 4>[:FUNCTION]:AUTO ON | OFF

This command either couples the detector to the current trace setting or turns coupling off.

Example: " :DET:AUTO OFF "

Features: *RST value: ON
SCPI: conforming

Mode: A

The trace is defined by the numeric suffix at DETECTOR.

:[SENSe<1|2>:]DDEMod:FORMat QPSK | PSK | MSK | QAM | FSK

This command selects the digital demodulation type.

Example: " :DDEM:FORM QPSK "
Features: *RST value: MSK
 SCPI: device-specific
Mode: VA-D

:[SENSe<1|2>:]DDEMod:SBANd NORMAl | INVerse

This command selects the sideband for the demodulation.

Example: " :DDEM:SBAN INV "
Features: *RST value: NORMAl
 SCPI: device-specific
Mode: VA-D

:[SENSe<1|2>:]DDEMod:QPSK:FORMat NORMAl | DIFFerential | OFFSet | DPI4

This command determines the specific demodulation type for QPSK.

Example: " :DDEM:QPSK:FORM DPI4 "
Features: *RST value: -
 SCPI: device-specific
Mode: VA-D

:[SENSe<1|2>:]DDEMod:PSK:NState 2 | 8

This command determines the specific demodulation type for PSK.

Example: " :DDEM:PSK:NST 2 "
Features: *RST value: -
 SCPI: device-specific
Mode: VA-D

Value 2 (i.e. PSK2) corresponds to BPSK demodulation, value 8 the 8PSK demodulation.

:[SENSe<1|2>:]DDEMod:PSK:FORMat NORMAl | DIFFerential | N3Pi8

This command determines the specific demodulation type for PSK.

Example: " :DDEM:PSK:FORM DIFF "
Features: *RST value: -
 SCPI: device-specific
Mode: VA-D

:[SENSe<1|2>:]DDEMod:MSK:FORMat TYPE1 | TYPE2 | NORMAl | DIFFerential

This command determines the specific demodulation type for MSK.

Example: " :DDEM:MSK:FORM TYPE2 "

Features: *RST value: TYPE2 | DIFFerential
SCPI: device-specific

Mode: VA-D

TYPE1 | NORMAl corresponds to MSK demodulation, TYPE2 | DIFFerential corresponds to DMSK demodulation.

:[SENSe<1|2>:]DDEMod:QAM:NSTate 16

This command determines the specific demodulation type for QAM.

Example: " :DDEM:QAM:NST 16 "

Features: *RST value: 16
SCPI: device-specific.

Mode: VA-D

:[SENSe<1|2>:]DDEMod:FSK:NSTate 2 | 4

This command determines the specific demodulation type for FSK.

Example: " :DDEM:FSK:NST 2 "

Features: *RST- value: -
SCPI: device-specific

Mode: VA-D

The parameter 2 corresponds to the demodulation type 2FSK, the parameter 4 to the demodulation type 4FSK.

:[SENSe<1|2>:]DDEMod:SRATe 160 Hz to 1.6 MHz

This command defines the symbol rate.

Example: " :DDEM:SRAT 18kHz "

Features: *RST value: 270.833333kHz
SCPI: device-specific

Mode: VA-D

:[SENSe<1|2>:]DDEMod:TIME 1 to Frame Length

The command determines the number of displayed symbols (result length).

Example: " :DDEM:TIME 80 "

Features: *RST value: 147
SCPI: device-specific

Mode: VA-D

:[SENSe<1|2>:]DDEMod:PRATe 1 | 2 | 4 | 8 | 16

This command determines the number of points per symbol.

Example: " :DDEM:PRAT 8 "
Features: *RST value: 4
 SCPI: device-specific
Mode: VA-D

:[SENSe<1|2>:]DDEMod:FILTer:MEASurement OFF | RCOSine | RRCosine | GAUSsian| B22 | B25 | B44 | QFM | FM95 | QFR | FR95 | QRM | RM95 | QRR | RR95 | A25Fm | EMES | EREF

This command selects the input filter for the test signal.

| | |
|-------------|--------------|
| B22 | Bessel 22 |
| B25 | Bessel 25 |
| B44 | Bessel 44 |
| QFM or FM95 | IS95-CDMA fm |
| QFR or FR95 | IS95-CDMA fr |
| QRM or RM95 | IS95-CDMA rm |
| QRR or RR95 | IS95-CDMA rr |
| A25Fm | APCO 25 fm |
| EMES | EDGE mes |
| EREF | EDGE ref |

Example: " :DDEM:FILT:MEAS RCOS "
Features: *RST value: OFF
 SCPI: device-specific
Mode: VA-D

:[SENSe<1|2>:]DDEMod:FILTer:REFerence RCOSine | RRCosine | GAUSsian| B22 | B25 | B44 | QFM | FM95 | QFR | FR95 | QRM | RM95 | QRR | RR95 | A25Fm | EMES | EREF

This command selects the input filter for the reference signal.

Example: " :DDEM:FILT:REF RCOS "
Features: *RST value: GAUSsian
 SCPI: device-specific
Mode: VA-D

:[SENSe<1|2>:]DDEMod:FILTer:ALPHA 0.2 to 1

This command determines the filter characteristic (ALPHA/BT). Step width is 0.05.

Example: " :DDEM:FILT:ALPH 0.5 "
Features: *RST value: 0.3
 SCPI: device-specific
Mode: VA-D

:[SENSe<1|2>:]DDEMod:NORMALize ON | OFF

This command switches normalizing of the unit circle on or off using IQ offset.

Example: " :DDEM:NORM OFF "
Features: *RST value: ON
 SCPI: device-specific
Mode: VA-D

:[SENSe<1|2>:]DDEMod:SEARch:PULSe:STATe ON | OFF

This command switches the signal burst search on or off.

Example: " :DDEM:SEAR:PULS:STAT OFF "
Features: *RST value: ON
 SCPI: device-specific
Mode: VA-D

:[SENSe<1|2>:]DDEMod:SEARch:SYNC:CATalog?

This command polls the names of all sync-file data sets stored on the harddisk. Syntax of output format:

<Sum of file lengths of all subsequent files>,<free memory on hard disk>,
 <1st file name>,,<1st file length>,<2nd file name>,,<2nd file length>,.....,<nth file name>,

Example: " :DDEM:SEAR:SYNC:CAT? "
Feature: *RST value: -
 SCPI: device-specific
Mode: VA-D

:[SENSe<1|2>:]DDEMod:SEARch:SYNC:SElect <string>

This command selects a predefined sync file. A file that has been set previously by the command DDEM:SEARch:SYNC:PATtern becomes invalid.

Example: " :DDEM:SEAR:SYNC:SEL "PATT_1" "
Feature: *RST value: ""
 SCPI: device-specific
Mode: VA-D

:[SENSe<1|2>:]DDEMod:SEARch:SYNC:OFFSet <numeric_value>

This command defines the offset of the display with reference to the synchronization sequence.

Example: " :DDEM:SEAR:SYNC:OFFS 10SYM "
Features: *RST value: 0 SYM
 SCPI: device-specific
Mode: VA-D

:[SENSe<1|2>:]DDEMod:SEARCh:SYNC:PATtern <string>

This command defines the synchronization sequence. A file that has been set previously by the command `DDEM:SEARCh:SYNC:SElect` becomes invalid.

Example: ":DDEM:SEAR:SYNC:PATT "1101001"

Features: *RST value: ""
 SCPI: device-specific

Mode: VA-D

:[SENSe<1|2>:]DDEMod:SEARCh:SYNC:STATe ON | OFF

This command switches the search for a synchronization sequence on or off.

Example: ":DDEM:SEARCh:SYNC:STAT ON"

Features: *RST value: OFF
 SCPI: device-specific

Mode: VA-D

:[SENSe<1|2>:]DDEMod:SEARCh:SYNC:NAME <string>

This command selects a sync file to be edited or entered anew.

Example: ":DDEM:SEAR:SYNC:NAME "PATT_NEW"

Feature: *RST value: ""
 SCPI: device-specific

Mode: VA-D

:[SENSe<1|2>:]DDEMod:SEARCh:SYNC:COMMeNT <string>

This command defines a comment on a sync file. This sync file must be previously selected by the command `DDEM:SEARCh:SYNC:NAME`.

Example: ":DDEM:SEAR:SYNC:COMM "PATTERN FOR PPSK"

Feature: *RST value: ""
 SCPI: device-specific

Mode: VA-D

:[SENSe<1|2>:]DDEMod:SEARCh:SYNC:DATA <string>

This command defines a synchronization pattern for the sync file. Inputs other than "1" or "0" are interpreted as "Don't Care Bits". This sync file must be previously selected by the command `DDEM:SEARCh:SYNC:NAME`.

Example: ":DDEM:SEAR:SYNC:DATA "1101001"

Feature: *RST value: ""
 SCPI: device-specific

Mode: VA-D

:[SENSe<1|2>:]DDEMod:SEARch:SYNC:DELeTe <string>

This command deletes a synchronization pattern on the hard disk. This sync file must be previously selected by the command `DDEM:SEARch:SYNC:NAME`.

Example: ":DDEM:SEAR:SYNC:DEL
Features: *RST-value: "
 SCPI: device-specific
Mode: VA-D

:[SENSe<1|2>:]DDEMod:SEARch:SYNC:MONLy ON | OFF

For setting ON, this command sets the analyzer so that the measured values are displayed and taken into account in the error analysis only if the set sync pattern is found. Bursts with a wrong sync pattern (sync not found) are ignored. If an invalid sync pattern is found or if there is none, the measurement is halted and continued in the presence of a valid sync pattern.

This command is available only if the search for a synchronization sequence is activated (`DDEM:SEARch:SYNC:STATe = ON`).

Example: ":DDEM:SEAR:SYNC:MONL ON"
Features: *RST value: OFF
 SCPI: device specific
Mode: VA-D

:[SENSe<1|2>:]DDEMod:SEARch:TIME 100 to 1600

This command determines the number of symbols required for demodulation (frame length). The values > 800 are only permissible if the number of points per symbol is <16, the values > 1600 only if the number of points per symbol is <8. Step width is 100.

Example: ":DDEM:SEAR:TIME 800 "
Features: *RST value: 400
 SCPI: device-specific
Mode: VA-D

:[SENSe<1|2>:]DDEMod:PRESet GSM | EDGe | TETRa | DCS1800 | PCS1900 | PHS | PDCup | PDCDown | APCO25CQPSK | APCO25C4FM | CDPD | DECT | CT2 | ERMes | MODacom | PWT | TFTS | F16 | F322 | F324 | F64 | FQCDma | F95Cdma | RQCDma | R95Cdma | FNADc | RNADc

This command selects an automatic setting of all modulation parameters according to a standard transmission method.

Example: " :DDEMod:PRESet TETRa "

Features: *RST value: GSM
SCPI: device-specific

Mode: VA-D

| | |
|-------------------|------------------------------------|
| APCO25CQPSK | APCO25 Continuous Phase QPSK |
| APCO25C4FM | APCO25 Continuous Phase 4FM |
| F16 | FLEX 1600 - 2FSK |
| F322 | FLEX 3200 - 2FSK, |
| F324 | FLEX 3200 - 4FSK |
| F64 | FLEX 6400 - 4FSK |
| FNADc | Forward NADC |
| RNADc | Reverse NADC |
| FQCDma or F95Cdma | Forward CDMA acc. to IS95 Standard |
| RQCDma or R95Cdma | Reverse CDMA acc. to IS95 Standard |

:[SENSe<1|2>:]TCAPture:LENGth 1024 | 2048 | 4096 | 8192 | 16384

This command determines the number of sampling points that are written into the memory for each measurement (memory size).

Example: "TCAPture:LENGth 1024"

Features: *RST value: 16384
SCPI: device-specific

Mode: VA-D

SENSe:FILTer Subsystem

The SENSe:FILTer subsystem selects the filters in the video signal path. This subsystem is active only in the Vector Signal Analysis mode (option FSE-B7).

| COMMAND | PARAMETERS | UNIT | COMMENT |
|-------------------------|-----------------|----------|------------------------|
| [SENSe<1 2>] :FILTer | | | Vector Signal Analyzer |
| :HPASs | | | |
| [:STATe] | <Boolean> | -- | |
| :FREQUency | <numeric_value> | HZ | |
| :LPASs | | | Vector Signal Analyzer |
| [:STATe] | <Boolean> | -- | |
| :FREQUency | <numeric_value> | HZ PCT | |
| :CCITt | | | |
| [:STATe] | <Boolean> | -- | |
| :CMESsage | | | |
| [:STATe] | <Boolean> | -- | |
| :DEMPHasis | | | |
| [:STATe] | <Boolean> | -- | |
| :TCONstant | <numeric_value> | S | |
| :LINK | DISPlay AUDio | | |

:[SENSe<1|2>]:FILTer:HPASs[:STATe] ON | OFF

This command activates the high-pass filter in the AF-branch for analog demodulation.

Example: " :FILT:HPAS ON"

Features: *RST value: OFF
SCPI: conforming

Mode: VA-A

:[SENSe<1|2>]:FILTer:HPASs:FREQUency 30 Hz | 300 Hz

In the Vector Signal Analysis mode with analog demodulation, this command defines the frequency limit of the high-pass filter in the AF-branch. For REAL TIME ON absolute frequencies are entered, for REAL TIME OFF, the frequencies are entered relative to the demodulation bandwidth.

Example: " :FILT:HPAS:FREQ 300HZ"

Features: *RST value: - (STATe = OFF)
SCPI: conforming

Mode: VA-A

:[SENSe<1|2>]:FILTer:LPASs[:STATe] ON | OFF

This command activates the low-pass filter in the AF-branch with analog demodulation.

Example: " :FILT:LPAS ON"

Features: *RST value: OFF
SCPI: conforming

Mode: VA-A

On switching to ON, a bandwidth of 3 kHz for REAL TIME ON and a bandwidth of 5 PCT for REAL TIME OFF is set automatically.

:[SENSe<1|2>:]FILTer:LPASs:FREQuency <numeric_value>

This command defines the frequency limit of the low-pass filter in the NF-branch for analog demodulation.

Parameter: <numeric_value> ::= 3 kHz | 15 kHz for REAL TIME ON
5 PCT | 10 PCT | 25 PCT for REAL TIME OFF

Example: " :FILT:LPAS:FREQ 3KHZ" for REAL TIME ON
" :FILT:LPAS:FREQ 25PCT" for REAL TIME OFF

Features: *RST value: - (STATe = OFF)
SCPI: conforming

Mode: VA-A

:[SENSe<1|2>:]FILTer:CCITt[:STATe] ON | OFF

This command activates the weighting filter according to CCITT-recommendation in the AF-branch for analog demodulation.

Example: " :FILT:CCIT ON"

Features: *RST value: OFF
SCPI: conforming

Mode: VA-A

This command is valid only in vector analysis mode with REAL TIME OFF.

:[SENSe<1|2>:]FILTer:CMESsage[:STATe] ON | OFF

This command activates the C-message weighting filter according to CCITT-recommendation in the AF-branch for analog demodulation.

Example: " :FILT:CMES ON"

Features: *RST value: OFF
SCPI: conforming

Mode: VA-A

This command is valid only in vector analysis mode with REAL TIME OFF.

:[SENSe<1|2>:]FILTer:DEMPHasis[:STATe] ON | OFF

This command activates the selected de-emphasis for analog demodulation.

Example: " :FILT:DEMP ON"

Features: *RST value: OFF
SCPI: conforming

Mode: VA-A

:[SENSe<1|2>:]FILTer:DEMPHasis:TCONstant 50US | 75US | 750US

This command sets the time constant of the de-emphasis for analog demodulation.

Example: " :FILT:DEMP:TCON 75US "

Features: *RST value: 50us
SCPI: conforming

Mode: VA-A

:[SENSe<1|2>:]FILTer:DEMPHasis:LINK DISPlay | AUDio

For analog demodulation, this command selects whether the de-emphasis set is to be active in the audio branch only or in addition for the display of measured values.

Example: " :FILT:DEMP:LINK DISP "

Features: *RST value: AUDio
SCPI: device-specific

Mode: VA-A

AUDio De-emphasis effective in the audio branch only

DISPlay De-emphasis effective in the audio branch and in the display of measured values

SENSe:FREQuency Subsystem

The SENSe:FREQuency subsystem defines the frequency axis of the active display. The frequency axis can either be defined via the start/stop frequency or via the center frequency and span.

| COMMAND | PARAMETERS | UNIT | COMMENT |
|----------------------------|-----------------------|------|---------|
| [SENSe<1 2>] :FREQuency | | | |
| :CENTer | <numeric_value> | HZ | |
| :LINK | START STOP SPAN | -- | |
| :STEP | <numeric_value> | HZ | |
| :LINK | SPAN RBW OFF | -- | |
| :FACTor | <numeric_value> | PCT | |
| :SPAN | <numeric value> | HZ | |
| :FULL | -- | -- | |
| :LINK | CENTer START STOP | -- | |
| :START | <numeric_value> | HZ | |
| :LINK | CENTer STOP SPAN | -- | |
| :STOP | <numeric_value> | HZ | |
| :LINK | CENTer START SPAN | -- | |
| :MODE | CW FIXed SWEEp | -- | |
| :OFFSet | <numeric_value> | HZ | |

: [SENSe<1|2>]:FREQuency:CENTer 0 GHz to f_{max}

This command defines the center frequency of the analyzer.

Example: " :FREQ:CENT 100MHz "

Features: *RST value: $f_{max} / 2$
SCPI: conforming

Modes: A, VA, MS, BTS

The automatic coupling of the parameters is set to SPAN FIXED.

: [SENSe<1|2>]:FREQuency:CENTer:LINK START | STOP | SPAN

This command defines the coupling of the center frequency to the start, stop frequency or the frequency span.

Example: " :FREQ:CENT:LINK STAR "

Features: *RST value: SPAN
SCPI: device-specific

Mode: A

: [SENSe<1|2>]:FREQuency:CENTer:STEP 0 to f_{max}

This command defines the step width of the center frequency.

Example: " :FREQ:CENT:STEP 120MHz "

Features: *RST value: - (AUTO 0.1 × SPAN is switched on)
SCPI: conforming

Modes: A, VA, BTS, MS

:[SENSe<1|2>:]FREQUENCY:CENTer:STEP:LINK SPAN | RBW | OFF

This command couples the step width of the center frequency to span (span >0) or to the resolution bandwidth (span = 0) or cancels the couplings.

Example: " :FREQ:CENT:STEP:LINK SPAN "

Features: *RST value: SPAN
SCPI: device-specific

Modes: A, BTS, MS

:[SENSe<1|2>:]FREQUENCY:CENTer:STEP:LINK:FACTor 1 to 100 PCT

This command couples the step width of the center frequency with a factor to the span (span >0) or to the resolution bandwidth (span = 0).

Example: " :FREQ:CENT:STEP:LINK:FACT 20PCT "

Features: *RST value: - (AUTO 0.1 × SPAN is switched on)
SCPI: device-specific

Modes: A, BTS, MS

:[SENSe<1|2>:]FREQUENCY:SPAN 0 GHz to f_{\max}

This command defines the frequency span of the analyzer.

Example: " :FREQ:SPAN 10MHz "

Features: *RST value: f_{\max}
SCPI: conforming

Mode: A

The automatic coupling of the parameters is set to CENTER FIXED.

:[SENSe<1|2>:]FREQUENCY:SPAN:FULL

This command sets the maximum frequency span of the analyzer.

Example: " :FREQ:SPAN:FULL "

Features: *RST value: -
SCPI: conforming

Mode: A

This command is an event which is why it is not assigned an *RST value and has no query.

:[SENSe<1|2>:]FREQUENCY:SPAN:LINK CENTER | START | STOP

This command defines the coupling for frequency-span changes.

Example: " :FREQ:SPAN:LINK STOP "

Features: *RST value: CENTER
SCPI: conforming

Mode: A

:[SENSe<1|2>:]FREQUency:STARt 0 GHz to f_{\max}

This command defines the start frequency of the analyzer.

Example: " :FREQ:STAR 20MHz "

Features: *RST value: 0
SCPI: conforming

Mode: A

The automatic coupling of the parameters is set to STOP FIXED.

:[SENSe<1|2>:]FREQUency:STARt:LINK CENTER | STOP | SPAN

This command defines the coupling for start-frequency changes.

Example: " :FREQ:STAR:LINK SPAN "

Features: *RST value: STOP
SCPI: device-specific

Mode: A

:[SENSe<1|2>:]FREQUency:STOP 0 GHz to f_{\max}

This command defines the stop frequency of the scan in receiver mode or the stop frequency of the analyzer.

Example: " :FREQ:STOP 2000MHz "

Features: *RST value: f_{\max}
SCPI: conforming

Mode: A

The automatic coupling of the parameters is set to STARt FIXED.

:[SENSe<1|2>:]FREQUency:STOP:LINK CENTER | STARt | SPAN

This command defines the coupling for stop-frequency changes.

Example: " :FREQ:STOP:LINK SPAN "

Features: *RST value: STARt
SCPI: device-specific

Mode: A

:[SENSe<1|2>:]FREQuency:MODE CW | FIXed | SWEEp

This command switches between frequency (SWEEp) and time (CW | FIXed) domain in the analyzer mode.

Example: " :FREQ:MODE SWE "

Features: *RST value: CW
SCPI: conforming

Mode: A

For CW and FIXed, the frequency setting is via command FREQuency:CENTer. In the SWEEp mode, the setting is via commands FREQuency:START, STOP, CENTer and SPAN.

:[SENSe<1|2>:]FREQuency:OFFSet <numeric_value>

This command defines the frequency offset of the instrument.

Example: " :FREQ:OFFS 1GHZ "

Features: *RST value: 0 Hz
SCPI: conforming

Modes: A, VA

SENSe:MIXer - Subsystem

The SENSe:MIXer subsystem controls the settings of the external mixer. It is only active in Analyzer mode (INSTRument SANalyzer).

This subsystem is available only if the instrument is equipped with the external mixer output (option FSE-B21)

The suffix in SENSe<1|2> is not significant in this subsystem.

| COMMAND | PARAMETERS | UNIT | COMMENT |
|--------------------------|-----------------------|------|----------------------------|
| :[SENSe<1 2>:] :MIXer | | | |
| [:STATe] | <Boolean> | -- | |
| :BLOCK | <Boolean> | | |
| :PORTs | 2 3 | | |
| :SIGNal | OFF ON AUTO | | |
| :THReshold | <numeric_value> | | |
| :HARMonic | <numeric_value> | -- | Only query in band lock on |
| :TYPE | ODD EVEN EODD | | Not in band lock off |
| :BAND | A Q U V E W F D G Y J | | Not in band lock off |
| :LOSS | | | |
| [:LOW] | <numeric_value> | DB | |
| :HIGH | <numeric_value> | DB | Not in band lock off |
| :TABLE | <file_name> | | |
| :BIAS | <numeric_value> | A | |

:[SENSe<1|2>:]MIXer[:STATe] ON | OFF

This command activates or shuts off the external mixer.

Example: " :MIX ON"

Features: *RST value: OFF
SCPI: device-specific

Mode: A

This command is available only in conjunction with option FSE-B21, External Mixer Output.

:[SENSe<1|2>:]MIXer:BLOCK ON | OFF

This command activates the BAND LOCK ON or BAND LOCK OFF mode.

Example: " :MIX:BLOCK ON"

Features: *RST value: OFF
SCPI: device-specific

Mode: A

This command is available only if the external mixer (option FSE-B21) is switched on.

:[SENSe<1|2>:]MIXer:PORTs 2 | 3

This command activates the 2- or 3-port mixer. In the BAND LOCK ON mode, the command refers to the active band selected with `SENSe:MIXer:HARMonic:BAND`.

Example: " :MIX:PORT 3 "

Features: *RST value: 2
SCPI: device-specific

Mode: A

This command is available only if the external mixer (option FSE-B21) is switched on.

:[SENSe<1|2>:]MIXer:SIGNal ON | OFF | AUTO

This command activates the Signal ID or Auto ID mode.

Example: " :MIX:SIGN ON "

Features: *RST value: OFF
SCPI: device-specific

Mode: A

This command is available only if the external mixer (option FSE-B21) is switched on.

:[SENSe<1|2>:]MIXer:THReshold 0.1 to 100 dB

This command sets the level threshold for auto ID.

Example: " :MIX:THR 20 "

Features: *RST value: 10
SCPI: device-specific

Mode: A

The command is available only if the external mixer (option FSE-B21) is switched on.

:[SENSe<1|2>:]MIXer:HARMonic 1 to 62

With BAND LOCK OFF, this command sets the nth harmonic. The command may be a query with BAND LOCK ON.

Example: " :MIX:HARM 5 "

Features: *RST value: 2
SCPI: conforming

Mode: A

The command is available only if the external mixer (option FSE-B21) is switched on.

:[SENSe<1|2>:]MIXer:HARMonic:TYPE ODD | EVEN | EODD

With BAND LOCK ON, this command sets the type of harmonic.

Example: " :MIX:HARM:TYPE EODD "

Features: *RST value: EVEN
SCPI: device-specific

Mode: A

The command is available only if the external mixer (option FSE-B21) is switched on.

:[SENSe<1|2>:]MIXer:HARMonic:BAND A|Q|U|V|E|W|F|D|G|Y|J

With BAND LOCK ON, this command sets the active band.

Example: " :MIX:HARM:BAND E "

Features: *RST value: U
SCPI: device-specific

Mode: A

The command is available only if the external mixer (option FSE-B21) is switched on.

:[SENSe<1|2>:]MIXer:LOSS[:LOW] <numeric_value>

This command sets the conversion loss of the mixer.

Example: " :MIX:LOSS -12DB "

Features: *RST value: 0 dB
SCPI: conforming

Mode: A

The command is available only if the external mixer (option FSE-B21) is switched on.

:[SENSe<1|2>:]MIXer:LOSS:HIGH <numeric_value>

With BAND LOCK ON, this command sets the conversion loss of the mixer for higher harmonics in bands with two harmonics (band A: even harmonics, band Q: odd harmonics).

Example: " :MIX:LOSS:HIGH -14DB "

Features: *RST value: 0 dB
SCPI: device-specific

Mode: A

The command is available only if the external mixer (option FSE-B21) is switched on.

:[SENSe<1|2>:]MIXer:LOSS:TABLE <file_name>

This command sets a conversion loss table.

Parameter: <file_name> := DOS file name

Example: " :MIX:LOSS:table 'mix_1' "

Features: *RST value: no table set
SCPI: device-specific

Mode: A

The command is available only if the external mixer (option FSE-B21) is switched on.

:[SENSe<1|2>:]MIXer:BIAS <numeric_value>

This command sets the bias current.

Example: " :MIX:BIAS 7mA "

Features: *RST value: 0 A
SCPI: conforming

Mode: A

The command is available only if the external mixer (option FSE-B21) is switched on.

SENSe:MSUMmary Subsystem

This subsystem controls the modulation summary setting for analog demodulation. It is active only in conjunction with option Vector Analysis, FSE-B7.

| COMMAND | PARAMETERS | UNIT | COMMENT |
|---|--|--------------------------------------|--|
| [SENSe<1 2>] :MSUMmary :AHOLd [:STATe] :MODE :RUNit :REFerence :AUTO :MTIMe | <Boolean> ABSolute RELative PCT DB <numeric_value> ONCE <numeric_value> | PCT HZ DEG RAD S | Vector Signal Analysis no query |

:[SENSe<1|2>]:MSUMmary:AHOLd[:STATe] ON | OFF

This command switches on the average/peak hold mode.

Example: " :MSUM:AHOL ON"

Features: *RST value: OFF
SCPI: device-specific

Mode: VA-A

:[SENSe<1|2>]:MSUMmary:MODE ABSolute | RELative

This command selects the absolute or relative indication of the summary marker values.

Example: " :MSUM:MODE REL"

Features: *RST value: ABSolute
SCPI: device-specific

Mode: VA-A

:[SENSe<1|2>]:MSUMmary:RUNit PCT | DB

This command selects the relative unit of the summary marker in the relative result display.

Example: " :MSUM:RUN DB"

Features: *RST value: DB
SCPI: device-specific

Mode: VA-A

:[SENSe<1|2>:]MSUMmary:REFerence <numeric_value>

This command selects the reference modulation.

Parameter: <numeric_value> := 0.001PCT to 1000PCT for AM
0.1HZ to 10MHZ for FM
0.0001RAD to 1000RAD for PM

Example: " :MSUM:REF 50PCT "

Features: *RST value: 100PCTfor AM
100KHZfor FM
10RAD for PM
SCPI: device-specific

Mode: VA-A

:[SENSe<1|2>:]MSUMmary:REFerence:AUTO ONCE

This command sets the current absolute measured values of the main modulation signal as reference values for the relative indication.

Example: " :MSUM:REF:AUTO ONCE "

Features: *RST value: --
SCPI: device-specific

Mode: VA-A

This command is an event and has therefore no query and no *RST value assigned.

:[SENSe<1|2>:]MSUMmary:MTIME 0.1 s | 1 s

This command selects the measurement time for the summary markers.

Example: " :MSUM:MTIM 100US "

Features: *RST value: 0.1S
SCPI: device-specific

Mode: VA-A

:[SENSe<1|2>:]POWer:ACHannel:ACPairs 1 | 2 | 3

This command sets the number of adjacent channels (upper and lower channel in pairs).

Example: " :POW:ACH:ACP 3 "

Features: *RST value: 1
SCPI: device-specific

Mode: A-F

:[SENSe<1|2>:]POWer:ACHannel:BANDwidth|BWIDth[:CHANnel] 0 Hz to 1000 MHz

This command sets the channel bandwidth of the radio communication system.

Example: " :POW:ACH:BWID 30kHz "

Features: *RST value: 24 kHz
SCPI: device-specific

Mode: A-F

If the channel bandwidth of the adjacent channel is changed the bandwidths of all alternate adjacent channels are automatically set to the same value.

:[SENSe<1|2>:]POWer:ACHannel:BANDwidth|BWIDth:ACHannel 0 Hz to 1000 MHz

This command defines the channel bandwidth of the adjacent channel of the radio transmission system.

Example: " :POW:ACH:BWID:ACH 30kHz "

Features: *RST value: 24 kHz
SCPI: device-specific

Mode: A-F

If the channel bandwidth of the adjacent channel is changed the bandwidths of all alternate adjacent channels are automatically set to the same value.

:[SENSe<1|2>:]POWer:ACHannel:BANDwidth|BWIDth:ALTErnate<1|2> 0 Hz to 1000 MHz

This command defines the channel bandwidth of the first/second alternate adjacent channel of the radio transmission system.

Example: " :POW:ACH:BWID:ALT2 30kHz "

Features: *RST value: 24 kHz
SCPI: device-specific

Mode: A-F

If the channel bandwidth of the alternate adjacent channel no. 1 is changed the bandwidth of the alternate adjacent channel no. 2 is automatically set to the same value.

:[SENSe<1|2>:]POWer:ACHannel:MODE ABSolute | RELative

This command toggles between absolute and relative measurement.

Example: " :POW:ACH:MODE REL "

Features: *RST value: ABSolute
SCPI: device-specific

Mode: A-F

For the relative measurement the reference value is set to the currently measured channel power by command `POW:ACH:REF:AUTO ONCE`.

:[SENSe<1|2>:]POWer:ACHannel:REFerence:AUTO ONCE

This command sets the reference value to the currently measured channel power.

Example: " :POW:ACH:REF:AUTO ONCE "

Features: *RST value: -
SCPI: device-specific

Mode: A-F

This command is an event which is why it is not assigned an *RST value and has no query.

:[SENSe<1|2>:]POWer:ACHannel:PRESet ACPower | CPOWer | OBANdwidth|OBWidth | CN | CN0 | ADJust

This command selects the type of power measurement and resets the instrument depending on the selected measurement.

The value `ADJust` optimizes automatically the settings (span, RBW, VBW and detector) of the analyzer for the power measurement selected by command `:CALCulate<1|2>:MARKer:FUNCTion:POWer:SElect` (see Softkey ADJUST CP SETTINGS).

Example: " :POW:ACH:REF:PRESet ACP "

Features: *RST value: -
SCPI: device-specific

Mode: A-F

:[SENSe<1|2>:]POWer:BANDwidth|BWIDth 0 to 100PCT

This command defines the percentage of the power with respect to the total power.

Example: " :POW:BWID 95PCT "

Features: *RST value: 99PCT
SCPI: device-specific

Mode: A-F

This value defines the occupied bandwidth (measurement `POW:ACH:PRESet OBW`).

SENSe:SWEep Subsystem

This subsystem controls the sweep parameters.

| COMMAND | PARAMETERS | UNIT | COMMENT |
|------------------------|----------------------|------|---------|
| [SENSe<1 2>] :SWEep | | | |
| :TIME | <numeric_value> | S | |
| :AUTO | <Boolean> | -- | |
| :COUNT | <numeric_value> | -- | |
| :EGATE | <Boolean> | -- | |
| :LEVEL | <numeric_value> | V | |
| :TYPE | LEVEL EDGE | -- | |
| :POLarity | POSitive NEGative | -- | |
| :HOLDoff | <numeric_value> | S | |
| :LENGTH | <numeric_value> | S | |
| :SOURce | EXTernal RFPower | -- | |
| :GAP | <Boolean> | -- | |
| :PRETrigger | <numeric_value> | S | |
| :TRGTogap | <numeric_value> | S | |
| :LENGTH | <numeric_value> | S | |
| :SPACing | LINear LOGarithmic | | |

:[SENSe<1|2>]:SWEep:TIME <numeric_value>

This command defines the duration of the sweep.

The allowed value range depends on the selected domain and, for frequency domain, on the set resolution bandwidth (see Chapter 4, Softkey SWEEP TIME MANUAL).

Example: " :SWE:TIME 10s "

Features: *RST value - (AUTO is set to ON)
SCPI: conforming

Modes: A, VA-A

If SWEep:TIME is directly programmed, automatic coupling is switched off.

:[SENSe<1|2>]:SWEep:TIME:AUTO ON | OFF

This command switches the automatic coupling of the sweep time for the frequency span or bandwidth settings.

Example: " :SWE:TIME:AUTO ON "

Features: *RST value: ON
SCPI: conforming

Mode: A

If SWEep:TIME is directly programmed, automatic coupling is switched off.

:[SENSe<1|2>:]SWEep:COUNT 0 to 32767

This command defines the number of sweeps started with single sweep.

Example: " :SWE:COUNT 64 "

Features: *RST value: 0
SCPI: conforming

Modes: A, VA-D

This parameter defines the number of sweeps or the number of averaging procedures. In the average mode, the value 0 defines a running averaging of measurement data over 10 sweeps.

:[SENSe<1|2>:]SWEep:EGATe ON | OFF

This command controls the sweep with the external gate signal.

Example: " :SWE:EGAT ON "

Features: *RST value: OFF
SCPI: device-specific

Mode: A

:[SENSe<1|2>:]SWEep:EGATe:LEVeL -5V to +5V

This command determines the threshold for the external gate signal.

Example: " :SWE:EGAT:LEV 3V "

Features: *RST value: 2V
SCPI: device-specific

Mode: A

If `SWEep:TIME` is directly programmed, automatic coupling is switched off.

:[SENSe<1|2>:]SWEep:EGATe:TYPE LEVeL | EDGE

This command sets the type of triggering (level or edge) by the external gate signal.

Example: " :SWE:EGAT:TYPE EDGE "

Features: *RST value: EDGE
SCPI: device-specific

Mode: A

Parameter `EGATe:LENGth` is not used for level triggering.

:[SENSe<1|2>:]SWEep:EGATe:POLarity POSitive | NEGative

This command determines the polarity of the external gate signal.

Example: " :SWE:EGAT:POL POS "

Features: *RST value: POSitive
SCPI: device-specific

Mode: A

:[SENSe<1|2>:]SWEep:EGATe:HOLDoff 0 to 100s

This command defines the delay time between the external gate signal and the continuation of the sweep.

Example: " :SWE:EGAT:HOLD 100us "

Features: *RST value: 0s
SCPI: device-specific

Mode: A

The values for the delay time can be set in steps 1, 2, 3 and 5.

:[SENSe<1|2>:]SWEep:EGATe:LENGth 0 to 100s

In case of edge triggering, this command determines the time interval in which the instrument sweeps.

Example: " :SWE:EGAT:LENG 10ms "

Features: *RST value: 0s
SCPI: device-specific

Modes: A

The values for the delay time can be set in steps 1, 2, 3 and 5.

:[SENSe<1|2>:]SWEep:EGATe:SOURce EXTernal | RFPower

This command toggles between external gate signal and RF power signal.

Example: " :SWE:EGAT:SOUR RFP "

Features: *RST value: EXTernal
SCPI: device-specific

Mode: A

:[SENSe<1|2>:]SWEep:GAP ON | OFF

This command controls the operating mode GAP SWEEP.

Example: " :SWE:GAP ON "

Features: *RST value: OFF
SCPI: device-specific

Mode: A-Z

Operating mode GAP SWEEP for measurements in the time domain controls the display of measured values. Measured values can be blanked for a defined time range (GAP).

:[SENSe<1|2>:]SWEep:GAP:PRETrigger 0 to 100s

This command defines the evaluation time for measured values before the pretrigger time (resolution: 50 ns).

Example: " :SWE:GAP:PRET 100us "

Features: *RST value: 0s
SCPI: device-specific

Mode: A

:[SENSe<1|2>:]SWEep:GAP:TRGTogap 0 to 100s

This command defines the time between the pretrigger time and the beginning of the gap (trigger-to-gap time) (resolution: 50 ns).

Example: " :SWE:GAP:TRGT 50us "

Features: *RST value: 0s
SCPI: device-specific

Mode: A

:[SENSe<1|2>:]SWEep:GAP:LENGth 0 to 100s

This command defines the gap length.

Example: " :SWE:GAP:LENG 400us "

Features: *RST value: 0s
SCPI: device-specific

Mode: A

The gap length can be programmed from 0 to 100s in steps of 1, 2, 3 and 5.

:[SENSe<1|2>:]SWEep:SPACing LINear | LOGarithmic

This command toggle between linear and logarithmic sweep.

Example: " :SWE:SPAC LOG "

Features: *RST value: LIN
SCPI: conforming

Modes: A,

The frequency axis is set to linear or logarithmic scaling accordingly.

SENSe:TV Subsystem

This subsystem controls the optional TV-demodulator (only in conjunction with option TV-Demodulator, FSE-B3).

| COMMAND | PARAMETERS | UNIT | COMMENT |
|--|------------------------------|----------|-----------------------|
| [SENSe<1 2>] :TV [:STATe] :PSOffset | <Boolean> <numeric_value> | -- HZ | Option TV-Demodulator |

: [SENSe<1|2>]:TV[:STATe] ON | OFF

This command switches the optional TV-demodulator on or off.

Example: " :TV ON "

Features: *RST value: OFF
SCPI: device-specific

Mode: A-Z

This command is available only in conjunction with option TV-Demodulator, FSE-B3.

: [SENSe<1|2>]:TV:PSOffset 0 to 6.5 MHz

This command defines the frequency offset between video and audio carrier of the measured signal.

Example: " :TV:PSOF 1 MHz "

Features: *RST value: 5 MHz
SCPI: device-specific

Mode: A-Z

This command is available only in conjunction with option TV-Demodulator, FSE-B3.

:SOURce<1|2>:FM:STATe ON | OFF

This command switches on or off the external frequency modulation of the tracking generator.

Example: " :SOUR:FM:STAT ON "

Features: *RST-value: OFF
SCPI: conforming

Modes: A, VA

External AM, external I/Q-modulation and frequency offset are switched off, if active. This command is only valid in conjunction with option Tracking Generator.

:SOURce<1|2>:FREQuency:OFFSet -200MHz to 200MHz

This command defines a frequency offset of the tracking generators to the current instrument frequency.

Example: " :SOUR:FREQ:OFFS "

Features: *RST-value: 0 Hz
SCPI: conforming

Modes: A, VA

External delta modulation is switched off, if active. This command is only valid in conjunction with option Tracking Generator.

:SOURce<1|2>:POWer:ALC:SOURce INTernal | EXTernal

This command switches on or off the external level control (ALC).

Example: " :SOUR:POW:ALC:SOUR INT "

Features: *RST-value: INT
SCPI: conforming

Modes: A, VA

External AM and external delta modulation are switched off, if active. This command is only valid in conjunction with option Tracking Generator.

:SOURce<1|2>:POWer[:LEVel][:IMMediate][:AMPLitude] -20dBm to 0dBm /
Option FSE-B12: -90dBm to 0dBm

This command defines the level of the tracking generator.

Example: " :SOUR:POW -20dBm "

Features: *RST-value: -20 dBm
SCPI: conforming

Modes: A, VA

This command is only valid in conjunction with option Tracking Generator.

:SOURce<1|2>:POWer[:LEVel][:IMMediate]:OFFSet -200dB to +200dB

This command defines a level offset for the tracking generator.

Example: " :SOUR:POW:OFFS -10dB "

Features: *RST-value: 0dB
SCPI: conforming

Modes: A, VA

This command is only valid in conjunction with option Tracking Generator.

STATus Subsystem

The STATus subsystem contains the commands for the status reporting system (see Chapter 5, Section "Status Reporting System"). *RST does not influence the status registers. The commands and events causing the status reporting system to be reset are comprised in a table at the end of chapter 5.

| COMMAND | PARAMETERS | UNIT | COMMENT |
|---------------|------------|------|---------|
| STATus | | | |
| :OPERation | | | |
| [:EVENT]? | -- | -- | |
| :CONDition? | -- | -- | |
| :ENABle | 0 to 65535 | -- | |
| :PTRansition | 0 to 65535 | -- | |
| :NTRansition | 0 to 65535 | -- | |
| :PRESet | -- | -- | |
| :QUEStionable | | | |
| [:EVENT]? | -- | -- | |
| :CONDition? | -- | -- | |
| :ENABle | 0 to 65535 | -- | |
| :PTRansition | 0 to 65535 | -- | |
| :NTRansition | 0 to 65535 | -- | |
| :POWer | | | |
| [:EVENT]? | -- | -- | |
| :CONDition? | -- | -- | |
| :ENABle | 0 to 65535 | -- | |
| :PTRansition | 0 to 65535 | -- | |
| :NTRansition | 0 to 65535 | -- | |
| :LIMit | | | |
| [:EVENT]? | -- | -- | |
| :CONDition? | -- | -- | |
| :ENABle | 0 to 65535 | -- | |
| :PTRansition | 0 to 65535 | -- | |
| :NTRansition | 0 to 65535 | -- | |
| :LMARgin | | | |
| [:EVENT]? | -- | -- | |
| :CONDition? | -- | -- | |
| :ENABle | 0 to 65535 | -- | |
| :PTRansition | 0 to 65535 | -- | |
| :NTRansition | 0 to 65535 | -- | |
| :SYNC | | | |
| [:EVENT]? | -- | -- | |
| :CONDition? | -- | -- | |
| :ENABle | 0 to 65535 | -- | |
| :PTRansition | 0 to 65535 | -- | |
| :NTRansition | 0 to 65535 | -- | |
| :ACPLimit | | | |
| [:EVENT]? | -- | -- | |
| :CONDition? | -- | -- | |
| :ENABle | 0 to 65535 | -- | |
| :PTRansition | 0 to 65535 | -- | |
| :NTRansition | 0 to 65535 | -- | |

| COMMAND | PARAMETERS | UNIT | COMMENT |
|---------------|------------|------|---------|
| STATUS | | | |
| :QUEStionable | -- | -- | |
| :FREQuency | -- | -- | |
| [:EVENT]? | 0 to 65535 | -- | |
| :CONDition? | 0 to 65535 | -- | |
| :ENABle | 0 to 65535 | -- | |
| :PTRansition | -- | -- | |
| :NTRansition | -- | -- | |
| :TRANsducer | | | |
| [:EVENT]? | -- | -- | |
| :CONDition? | -- | -- | |
| :ENABle | 0 to 65535 | -- | |
| :PTRansition | 0 to 65535 | -- | |
| :NTRansition | 0 to 65535 | -- | |
| :QUEue? | -- | -- | |
| [:NEXT]? | -- | -- | |

:STATus:OPERation[:EVENT]?

This command queries the contents of the EVENT section of the :STATus:OPERation register.

Example: " :STAT:OPER? "

Features: *RST value: –
SCPI: conforming

Modes: A, VA, BTS, MS

The contents of the EVENT section is deleted with readout.

:STATus:OPERation:CONDition?

This command queries the CONDition section of the :STATus:OPERation register.

Example: " :STAT:OPER:COND? "

Features: *RST value: –
SCPI: conforming

Modes: A, VA, BTS, MS

Readout does not delete the contents of the CONDition section. The value returned reflects the current hardware status.

:STATus:OPERation:ENABLE 0 to 65535

This command sets the bits of the ENABLE section of the :STATus:QUEStionable register.

Example: " :STAT:OPER:ENAB 65535 "

Features: *RST value: –
SCPI: conforming

Modes: A, VA, BTS, MS

The ENABLE register selectively enables the individual events of the associated EVENT section for the sum bit in the status byte.

:STATus:OPERation:PTRansition 0 to 65535

This command sets the edge detectors of all bits of the :STATus:OPERation register from 0 to 1 for the transitions of the CONDition bit.

Example: " :STAT:OPER:PTR 65535 "

Features: *RST value: –
SCPI: conforming

Modes: A, VA, BTS, MS

:STATus:OPERation:NTRansition 0 to 65535

This command sets the edge detectors of all bits of the :STATus:OPERation register from 1 to 0 for the transitions of the CONDition bit.

Example: " :STAT:OPER:NTR 65535 "

Features: *RST value: –
SCPI: conforming

Modes: A, VA, BTS, MS

:STATus:PRESet

This command resets the edge detectors and ENABLE parts of all registers to a defined value. All PTRansition parts are set to FFFFh, i.e., all transitions from 0 to 1 are detected. All NTRansition parts are set to 0, i.e., a transition from 1 to 0 in a CONDition bit is not detected. The ENABLE part of the :STATus:OPERation and :STATus:QUEStionable registers are set to 0, i.e., all events in these registers are not passed on.

Example: " :STAT:PRES "

Features: *RST value: –
SCPI: conforming

Modes: A, VA, BTS, MS

:STATus:QUEStionable[:EVENT]?

This command queries the contents of the EVENT section of the :STATus:QUEStionable register.

Example: " :STAT:QUES?"

Features: *RST value: –
SCPI: conforming

Modes: A, VA, BTS, MS

Readout deletes the contents of the EVENT section.

:STATus:QUEStionable:CONDition?

This command queries the CONDition section of the :STATus:QUEStionable register.

Example: " :STAT:QUES:COND?"

Features: *RST value: –
SCPI: conforming

Modes: A, VA, BTS, MS

Readout does not delete the contents of the CONDition section.

:STATus:QUEStionable:ENABle 0 to 65535

This command sets the bits of the ENABle section of the STATus-QUEStionable register.

Example: " :STAT:QUES:ENAB 65535 "

Features: *RST value: –
SCPI: conforming

Modes: A, VA, BTS, MS

The ENABle register selectively enables the individual events of the associated EVENT section for the sum bit in the status byte.

:STATus:QUEStionable:PTRansition 0 to 65535

This command sets the edge detectors of all bits of the :STATus:OPERation register from 0 to 1 for the transitions of the CONDition bit.

Example: " :STAT:QUES:PTR 65535 "

Features: *RST value: –
SCPI: conforming

Modes: A, VA, BTS, MS

:STATus:QUEStionable:NTRansition 0 to 65535

This command sets the edge detectors of all bits of the :STATus:OPERation register from 1 to 0 for the transitions of the CONDition bit.

Example: " :STAT:QUES:NTR 65535 "

Features: *RST value: –
SCPI: conforming

Modes: A, VA, BTS, MS

:STATus:QUEStionable:POWEr[:EVENT]?

This command queries the contents of the EVENT section of the :STATus:QUEStionable:POWEr register.

Example: " :STAT:QUES?"

Features: *RST value: –
SCPI: conforming

Modes: A, VA, BTS, MS

Readout deletes the contents of the EVENT section.

:STATus:QUEStionable:POWEr:CONDition?

This command queries the content of the CONDition section of the :STATus:QUEStionable:POWEr register.

Example: " :STAT:QUES:COND?"

Features: *RST value: –
SCPI: conforming

Modes: A, VA, BTS, MS

Readout does not delete the contents of the CONDition section.

:STATus:QUEStionable:POWEr:ENABle 0 to 65535

This command sets the bits of the ENABle section of the :STATus:QUEStionable:POWEr register.

Example: " :STAT:QUES:ENAB 65535 "

Features: *RST value: –
SCPI: conforming

Modes: A, VA, BTS, MS

The ENABle register selectively enables the individual events of the associated EVENT section for the sum bit in the status byte.

:STATus:QUEStionable:POWEr:PTRansition 0 to 65535

This command sets the edge detectors of all bits of the :STATus:QUEStionable:POWEr register from 0 to 1 for the transitions of the CONDition bit.

Example: " :STAT:QUES:PTR 65535 "

Features: *RST-value: –
SCPI: conforming

Modes: A, VA, BTS, MS

:STATus:QUEStionable:POWEr:NTRansition 0 to 65535

This command sets the edge detectors of all bits of the :STATus:QUEStionable:POWEr register from 1 to 0 for the transitions of the CONDition bit.

Example: " :STAT:QUES:NTR 65535 "

Features: *RST value: –
SCPI: conforming

Modes: A, VA, BTS, MS

:STATus:QUEStionable:LIMit[:EVENT]?

This command queries the contents of the EVENT section of the :STATus:QUEStionable:LIMit register.

Example: " :STAT:QUES?"

Features: *RST value: –
SCPI: device-specific

Modes: A, VA, BTS, MS

Readout deletes the contents of the EVENT section.

:STATus:QUEStionable:LIMit:CONDition?

This command queries the contents of the CONDition section of the :STATus:QUEStionable:LIMit register.

Example: " :STAT:QUES:COND?"

Features: *RST value: –
SCPI: device-specific

Modes: A, VA, BTS, MS

Readout does not delete the contents of the CONDition section.

:STATus:QUEStionable:LIMit:ENABle 0 to 65535

This command sets the bits of the ENABle section of the :STATus:QUEStionable register.

Example: " :STAT:QUES:ENAB 65535 "

Features: *RST value: –
SCPI: device-specific

Modes: A, VA, BTS, MS

The ENABle register selectively enables the individual events of the associated EVENT section for the sum bit in the status byte.

:STATus:QUEStionable:LIMit:PTRansition 0 to 65535

This command sets the edge detectors of all bits of the :STATus:QUEStionable:LIMit register from 0 to 1 for the transitions of the CONDition bit.

Example: " :STAT:QUES:PTR 65535 "

Features: *RST value: –
SCPI: device-specific

Modes: A, VA, BTS, MS

:STATus:QUEStionable:LIMit:NTRansition 0 to 65535

This command sets the edge detectors of all bits of the :STATus:QUEStionable:LIMit register from 1 to 0 for the transitions of the CONDition bit.

Example: " :STAT:QUES:NTR 65535 "

Features: *RST value: –
SCPI: device-specific

Modes: A, VA, BTS, MS

:STATus:QUEStionable:LMARgin[:EVENT]?

This command queries the contents of the EVENT section of the :STATus:QUEStionable:LMARgin register.

Example: " :STAT:QUES? "

Features: *RST value: –
SCPI: device-specific

Modes: A, VA, BTS, MS

Readout deletes the contents of the EVENT section.

:STATus:QUEStionable:LMARgin:CONDition?

This command queries the contents of the CONDition section of the :STATus:QUEStionable:LMARgin register.

Example: " :STAT:QUES:COND? "

Features: *RST value: –
SCPI: device-specific

Modes: A, VA, BTS, MS

Readout does not delete the contents of the CONDition section.

:STATus:QUEStionable:LMARgin:ENABLE 0 to 65535

This command sets the bits of the ENABLE section of the :STATus:QUEStionable:LMARgin register.

Example: " :STAT:QUES:ENAB 65535 "

Features: *RST value: –
SCPI: device-specific

Modes: A, VA, BTS, MS

The ENABLE register selectively enables the individual events of the associated EVENT section for the sum bit in the status byte.

:STATus:QUEStionable:LMARgin:PTRansition 0 to 65535

This command sets the edge detectors of all bits of the :STATus:QUEStionable:LMARgin register from 0 to 1 for the transitions of the CONDition bit.

Example: " :STAT:QUES:PTR 65535 "

Features: *RST value: –
SCPI: device-specific

Modes: A, VA, BTS, MS

:STATus:QUEStionable:LMARgin:NTRansition 0 to 65535

This command sets the edge detectors of all bits of the :STATus:QUEStionable:LMARgin register from 1 to 0 for the transitions of the CONDition bit.

Example: " :STAT:QUES:NTR 65535 "

Features: *RST value: –
SCPI: device-specific

Modes: A, VA, BTS, MS

:STATus:QUEStionable:SYNC[:EVENT]?

This command queries the contents of the EVENT section of the :STATus:QUEStionable:SYNC register.

Example: " :STAT:QUES? "

Features: *RST value: –
SCPI: device-specific

Modes: A, VA, BTS, MS

Readout deletes the contents of the EVENT section.

:STATus:QUEStionable:SYNC:CONDition?

This command queries the contents of the CONDition section of the :STATus:QUEStionable:SYNC register.

Example: " :STAT:QUES:COND? "

Features: *RST value: –
SCPI: device-specific

Modes: A, VA, BTS, MS

Readout does not delete the contents of the CONDition section.

:STATus:QUEStionable:SYNC:ENABLE 0 to 65535

This command sets the bits of the ENABLE section of the :STATus:QUEStionable: SYNC register.

Example: " :STAT:QUES:ENAB 65535 "

Features: *RST value: –
SCPI: device-specific

Modes: A, VA, BTS, MS

The ENABLE register selectively enables the individual events of the associated EVENT section for the sum bit in the status byte.

:STATus:QUEStionable:SYNC:PTRansition 0 to 65535

This command sets the edge detectors of all bits of the :STATus:QUEStionable: SYNC register from 0 to 1 for the transitions of the CONDition bit.

Example: " :STAT:QUES:PTR 65535 "

Features: *RST value: –
SCPI: device-specific

Modes: A, VA, BTS, MS

:STATus:QUEStionable:SYNC:NTRansition 0 to 65535

This command sets the edge detectors of all bits of the :STATus:QUEStionable: SYNC register from 1 to 0 for the transitions of the CONDition bit.

Example: " :STAT:QUES:NTR 65535 "

Features: *RST value: –
SCPI: device-specific

Modes: A, VA, BTS, MS

:STATus:QUEStionable:ACPLimit[:EVENT]?

This command queries the contents of the EVENT section of the :STATus:QUEStionable:ACPLimit register.

Example: " :STAT:QUES:ACPL?"

Features: *RST value: –
SCPI: device-specific

Modes: A, VA, BTS, MS

Readout deletes the contents of the EVENT section.

:STATus:QUEStionable:ACPLimit:CONDition?

This command queries the contents of the CONDition section of the :STATus:QUEStionable:ACPLimit register.

Example: " :STAT:QUES:ACPL:COND?"

Features: *RST value: –
SCPI: device-specific

Modes: A, VA, BTS, MS

Readout does not delete the contents of the CONDition section.

:STATus:QUEStionable:ACPLimit:ENABLE 0 to 65535

This command sets the bits of the ENABLE section of the :STATus:QUEStionable:ACPLimit register.

Example: " :STAT:QUES:ACPL:ENAB 65535 "

Features: *RST value: –
SCPI: device-specific

Modes: A, VA, BTS, MS

The ENABLE register selectively enables the individual events of the associated EVENT section for the sum bit in the status byte.

:STATus:QUEStionable:ACPLimit:PTRansition 0 to 65535

This command sets the edge detectors of all bits of the :STATus:QUEStionable: ACPLimit register from 0 to 1 for the transitions of the CONDition bit.

Example: " :STAT:QUES:ACPL:PTR 65535 "

Features: *RST value: –
SCPI: device-specific

Modes: A, VA, BTS, MS

:STATus:QUEStionable:ACPLimit:NTRansition 0 to 65535

This command sets the edge detectors of all bits of the :STATus:QUEStionable: ACPLimit register from 1 to 0 for the transitions of the CONDition bit.

Example: " :STAT:QUES:ACPL:NTR 65535 "

Features: *RST value: –
SCPI: device-specific

Modes: A, VA, BTS, MS

:STATus:QUEStionable:FREQuency[:EVENT]?

This command queries the contents of the EVENT section of the :STATus:QUEStionableFREQuency register.

Example: " :STAT:QUES:FREQ? "

Features: *RST value: –
SCPI: device-specific

Modes: A, VA, BTS, MS

Readout deletes the contents of the EVENT section.

:STATus:QUEStionable:FREQuency:CONDition?

This command queries the contents of the CONDition section of the :STATus:QUEStionable:FREQuency register.

Example: " :STAT:QUES:FREQ:COND? "

Features: *RST value: –
SCPI: device-specific

Modes: A, VA, BTS, MS

Readout does not delete the contents of the CONDition section.

:STATus:QUEStionable:FREQuency:ENABle 0 to 65535

This command sets the bits of the ENABle section of the :STATus:QUEStionable:FREQuency register.

Example: " :STAT:QUES:FREQ:ENAB 65535 "

Features: *RST value: –
SCPI: device-specific

Modes: A, VA, BTS, MS

The ENABle register selectively enables the individual events of the associated EVENT section for the sum bit in the status byte.

:STATus:QUEStionable:FREQuency:PTRansition 0 to 65535

This command sets the edge detectors of all bits of the :STATus:QUEStionable:FREQuency register from 0 to 1 for the transitions of the CONDition bit.

Example: " :STAT:QUES:FREQ:PTR 65535 "

Features: *RST value: –
SCPI: device-specific

Modes: A, VA, BTS, MS

:STATus:QUEStionable:FREQuency:NTRansition 0 to 65535

This command sets the edge detectors of all bits of the :STATus:QUEStionable:FREQuency register from 1 to 0 for the transitions of the CONDition bit.

Example: " :STAT:QUES:FREQ:NTR 65535 "

Features: *RST value: –
SCPI: device-specific

Modes: A, VA, BTS, MS

:STATus:QUEStionable:TRANsducer[:EVENT]?

This command queries the contents of the EVENT section of the :STATus:QUEStionable:TRANsducer register.

Example: " :STAT:QUES:TRAN? "

Features: *RST value: –
SCPI: device-specific

Modes: A, VA, BTS, MS

Readout deletes the contents of the EVENT section.

:STATus:QUEStionable:TRANsducer:CONDition?

This command queries the contents of the CONDition section of the :STATus:QUEStionable:FREQuency register.

Example: " :STAT:QUES:TRAN:COND? "

Features: *RST value: –
SCPI: device-specific

Modes: A, VA, BTS, MS

Readout does not delete the contents of the CONDition section.

:STATus:QUEStionable:TRANsducer:ENABle 0 to 65535

This command sets the bits of the ENABle section of the :STATus:QUEStionable:TRANsducer register.

Example: " :STAT:QUES:TRAN:ENAB 65535 "

Features: *RST value: –
SCPI: device-specific

Modes: A, VA, BTS, MS

The ENABle register selectively enables the individual events of the associated EVENT section for the sum bit in the status byte.

:STATus:QUEStionable:TRANsducer:PTRansition 0 to 65535

This command sets the edge detectors of all bits of the :STATus:QUEStionable:TRANsducer register from 0 to 1 for the transitions of the CONDition bit.

Example: " :STAT:QUES:TRAN:PTR 65535 "

Features: *RST value: –
SCPI: device-specific

Modes: A, VA, BTS, MS

:STATus:QUEStionable:TRANsducer:NTRansition 0 to 65535

This command sets the edge detectors of all bits of the :STATus:QUEStionable:TRANsducer register from 1 to 0 for the transitions of the CONDition bit.

Example: " :STAT:QUES:TRAN:NTR 65535 "

Features: *RST value: –
SCPI: device-specific

Modes: A, VA, BTS, MS

:STATus:QUEue[:NEXT]?

This command queries the earliest entry to the error queue, thus deleting it.

Example: " :STAT:QUE? "

Features: *RST value: –
SCPI: conforming

Modes: A, VA, BTS, MS

Positive error numbers indicate device-specific errors, negative error numbers are error messages defined by SCPI (cf. Chapter 9). If the error queue is empty, the error number 0, "no error", is returned. This command is identical with the command `SYSTEM:ERROR`.

SYSTEM Subsystem

This subsystem comprises a series of commands for general functions.

| COMMAND | PARAMETERS | UNIT | COMMENT |
|---------------|---------------------------|------|------------------------|
| SYSTEM | | | |
| :COMMunicate | | | |
| :GPIB | | | |
| [:SELF] | | | |
| :ADDRess | 0 to 30 | -- | |
| :RTERminator | LFEoi EOI | | |
| :RDEvice<1 2> | | | |
| :ADDRess | 0 to 30 | -- | |
| :SERial<1 2> | | | |
| :CONTrol | | | |
| :DTR | IBFull OFF | | |
| :RTS | IBFull OFF | | |
| [:RECeive] | | -- | |
| :BAUD | <numeric_value> | -- | |
| :BITS | 7 8 | | |
| :PARity | | | |
| [:TYPE] | EVEN ODD NONE | -- | |
| :SBITs | 1 2 | | |
| :PACE | XON NONE | -- | |
| :PRINter1 2> | | -- | FSE with NT controller |
| :ENUMerate | | | |
| [:NEXT]? | | | query only |
| :FIRSt? | | | query only |
| :SElect | <printer_name> | -- | |
| :DATE | <num>, <num>, <num> | | |
| :DISPlay | | | |
| :UPDate | ON OFF | | |
| :ERRor? | -- | | query only |
| :FIRMware | | -- | FSE with NT controller |
| :UPDate | <string> | -- | no query |
| :PASSword | | -- | |
| [:CENable] | <string> | -- | no query |
| :PRESet | -- | | no query |
| :SET | <block> | | |
| :SPEaker<1 2> | | | |
| :VOLume | <numeric_value> | | |
| :TIME | 0 to 23, 0 to 59, 0 to 59 | | query only |
| :VERSion? | -- | | query only |
| :BINFo? | -- | | |

:SYSTEM:COMMunicate:GPIB[:SELF]:ADDRess 0 to 30

This command changes the IEC/IEEE-bus address of the unit.

Example: " :SYST:COMM:GPIB:ADDR 18 "

Features: *RST value: - (no influence on this parameter)
 SCPI: conforming

Modes: A, VA, BTS, MS

:SYSTEM:COMMunicate:GPIB[:SELF]:RTERminator LFEOI | EOI

This command changes the delimiter.

Example: " :SYST:COMM:GPIB:RTER EOI "

Features: *RST value: LFEOI
SCPI: device-specific

Modes: A, VA, BTS, MS

The instrument contains a DMA-channel for communication via IEC-bus. This ensures maximum speed for the transfer of commands and data. The parser for command decoding integrated in the instrument is, however, only activated by the delimiter when the command is completely transferred. In order to make this possible for the transfer of binary data, too (e. g. trace data which are retransferred into the instrument), the delimiter recognition must be switched to the EOI signal prior to the transfer. Output of binary data from the instrument does not require such a switching.

:SYSTEM:COMMunicate:GPIB:RDEvice<1|2>:ADDRess 0 to 30

This command changes the IEC/IEEE-bus address of the unit which is selected as hardcopy device 1 or 2, provided that the IEC/IEEE-bus interface of this unit is set as an interface.

Example: " :SYST:COMM:GPIB:RDEV2:ADDR 5 "

Features: *RST value: 4
SCPI: conforming

Modes: A, VA, BTS, MS

:SYSTEM:COMMunicate:SERial<1|2>:CONTrol:DTR IBFull | OFF**:SYSTEM:COMMunicate:SERial<1|2>:CONTrol:RTS** IBFull | OFF

These commands switch the hardware handshake procedure for the given serial interface off (OFF) or on (IBFull).

Examples: " :SYST:COMM:SER:CONT:DTR OFF "
" :SYST:COMM:SER2:CONT:RTS IBF "

Features: *RST value: OFF
SCPI: conforming

Modes: A, VA, BTS, MS

The two commands have the same meaning. SERial1 and SERial 2 correspond to device COM1 and COM2, respectively.

:SYSTEM:COMMunicate:SERial<1|2>[:RECeive]:BAUD 75 | 150 | 300 | 600 | 1200 | 2400 | 9600

This command sets the transmission speed for the given serial interface.

Example: " :SYST:COMM:SER:BAUD 2400 "

Features: *RST value: 9600
SCPI: conforming

Modes: A, VA, BTS, MS

SERial1 and SERial 2 correspond to device interface COM1 and COM2, respectively. Permissible values are 75 Baud, 150 Baud, 300 Baud, 600 Baud, 1200 Baud, 2400 Baud, 4800 Baud, 9600 Baud.

:SYSTEM:COMMunicate:SERial<1|2>[:RECeive]:BITS 7 | 8

This command defines the number of data bits per data word for the given serial interface.

Example: " :SYST:COMM:SER2:BITS 7 "

Features: *RST value: 8
SCPI: conforming

Modes: A, VA, BTS, MS

SERial1 and SERial 2 correspond to device interface COM1 and COM2, respectively.

:SYSTEM:COMMunicate:SERial<1|2>[:RECeive]:PARity[:TYPE] EVEN | ODD | NONE

This command defines the parity check for the given serial interface.

Example: " :SYST:COMM:SER:PAR EVEN "

Features: *RST value: NONE
SCPI: conforming

Modes: A, VA, BTS, MS

SERial1 and SERial 2 correspond to device interface COM1 and COM2, respectively. Permissible values are:

EVEN even parity
ODD odd parity
NONE no parity check.

:SYSTEM:COMMunicate:SERial<1|2>[:RECeive]:SBITS 1|2

This command defines the number of stopbits per data word for the given serial interface.

Example: " :SYST:COMM:SER:SBITS 2 "

Features: *RST value: 1
SCPI: conforming

Modes: A, VA, BTS, MS

SERial1 and SERial 2 correspond to device interface COM1 and COM2, respectively.

:SYSTEM:COMMunicate:SERial<1|2>[:RECeive]:PACE XON | NONE

This command switches on or off the software handshake for the given serial interface.

Example: " :SYST:COMM:SER:PACE XON "

features: *RST value: NONE
SCPI: conforming

Modes: A, VA, BTS, MS

SERial1 and SERial 2 correspond to device interface COM1 and COM2, respectively.

:SYSTEM:COMMunicate:PRINter<1|2>:ENUMerate:FIRSt?

This command queries the name of the first printer (in the list of printers) under Windows NT.

The names of other installed printers can be queried with command :SYSTEM:COMMunicate:PRINter:ENUMerate:NEXT?. The numeric suffix in PRINter<1|2> is not significant.

If no printer is configured an empty string is output.

Example: " :SYST:COMM:PRIN:ENUM:FIRS? "

Features: *RST value: -
SCPI: device-specific

Modes: A, VA

This command is only available for instruments equipped with Windows NT controller.

:SYSTEM:COMMunicate:PRINter<1|2>:ENUMerate:NEXT?

This command queries the name of the next printer installed under Windows NT.

This command can only be sent after command :SYSTEM:COMMunicate:PRINter:ENUMerate:FIRSt?.

An empty string is output after all printer names have been output. The numeric suffix in PRINter<1|2> is not significant.

Example: " :SYST:COMM:PRIN:ENUM:NEXT? "

Features: *RST value: -
SCPI: device-specific

Modes: A, VA

This command is only available for instruments equipped with Windows NT controller.

:SYSTEM:COMMunicate:PRINter<1|2>:SElect <printer_name>

This command selects one of the printers installed under Windows NT.

The name of the first printer is queried with FIRSt?. After that the names of other installed printers can be queried with NEXT?. The numeric suffix in PRINter<1|2> selects the device.

Parameter: <printer_name> ::= string which has been queried with commands :SYSTEM:COMMunicate :PRINter:ENUMerate:FIRSt? and NEXT?.

Example: " :SYST:COMM:PRIN:SEL 'HP_DESKJET660' "

Features: *RST value: -
SCPI: device-specific

Modes: A, VA

This command is only available for instruments equipped with Windows NT controller.

:SYSTEM:DATE 1980 to 2099, 1 to 12, 1 to 31

This command is used to enter the date for the internal calendar.

Example: " SYST:DATE 1994,12,1 "

Features: *RST value: -
SCPI: conforming

Modes: A, VA, BTS, MS

The sequence of entry is year, month, day.

:SYSTem:DISPlay:UPDate ON | OFF

This command switches on or off the update of all display elements.

Example: " SYST:DISP:UPD ON
Features: *RST value: OFF
 SCPI: device specific
Modes: A, VA, BTS, MS

:SYSTem:ERRor?

This command queries the earliest entry to the error queue, thus deleting it. .

Example: " :SYST:ERR? "
Features: *RST value: –
 SCPI: conforming
Modes: A, VA, BTS, MS

Positive error numbers indicate device-specific errors, negative error numbers are error messages defined by SCPI (cf. Chapter 9). If the error queue is empty, the error number 0, "no error", is returned. This command is identical with the command :STATus:QUEue:NEXT?. This command is a query which is why it is not assigned an *RST value.

:SYSTem:FIRMware:UPDate <string>

This command starts a firmware update using the files in the set directory.

Example : " :SYST:FIRM:UPD 'C:\V4.32' "
Features : *RST value: –
 SCPI : conforming
Mode: A, VA, BTS, MS

This command is an event and has therefore no query and no *RST value assigned.

:SYSTem:PASSword[:CENable] <string>

This command enables access to the service functions by means of the password.

Example: " :SYST:PASS 'XXXX' "
Features: *RST value: –
 SCPI: conforming
Modes: A, VA, BTS, MS

This command is an event which is why it is not assigned an *RST value and has no query.

:SYSTEM:SET <block>

The query `:SYSTEM:SET?` causes the data of the current instrument setting to be transmitted to the controller in binary form (SAVE function). The data can be read back into the instrument (RECALL function) by means of command `:SYSTEM:SET <block>`. If the data records are stored on the instrument harddisk with SAVE/RECALL (`:MMEMORY:STORE` bzw. `:MMEMORY:LOAD`), it is possible to store the data in an external computer by means of `:SYSTEM:SET`.

Example: `" :SYST:SET "`

Features: *RST value: –
 SCPI: conforming

Modes: A, VA, BTS, MS

The receive terminator has to be set to EOI to ensure reliable transfer of data (setting `SYST:COMM:GPIB:RTER EOI`).

:SYSTEM:PRESet

This command triggers an instrument reset.

Example: `" :SYST:PRES "`

Features: *RST value: –
 SCPI: conforming

Modes: A, VA, BTS, MS

The effect of this command corresponds to that of the *PRESET* key with manual control or to the *RST command.

:SYSTEM:SPEaker<1|2>:VOLume 0 to 1

This command sets the volume of the built-in loudspeaker for demodulated signals. The numeric suffix selects the measurement window.

Example: `" :SYST:SPE:VOL 0.5 "`

Features: *RST value: 0
 SCPI: device-specific

Modes: A

The value 0 is the lowest volume, the value 1 is the highest volume.

:SYSTEM:TIME 0 to 23, 0 to 59, 0 to 59

This command sets the internal clock.

Example: `" :SYST:TIME 12,30,30 "`

Features: *RST value: –
 SCPI: conforming

Modes: A, VA, BTS, MS

The sequence of entry is hour, minute, second.

:SYSTEM:VERSion?

This command queries the number of the SCPI version, which is relevant for the instrument.

Example: " :SYST:VERS? "

Features: *RST value: –
SCPI: conforming

Modes: A, VA, BTS, MS

This command is a query which is why it is not assigned an *RST value.

:SYSTEM:BINFo?

This command queries all present modules with model index, modification index and HW code. Entries are separated by commas.

Return format: module1, model index1, modification index1, HW code1, module2, model index2, modification index2, HW code2, module3,...,moduleN, model indexN, modification indexN, HW codeN

Example: " :SYST:BINF? "

Features: *RST value: –
SCPI: device-specific

Modes: A, VA, BTS, MS

TRACe Subsystem

The TRACe subsystem controls access to the instrument's internal trace memory.

| COMMAND | PARAMETERS | UNIT | COMMENT |
|---------------------------|--|------|---------|
| TRACe [:DATA] :COPY | @TRACE1 TRACE2 TRACE3 TRACE4,@<block> <numeric_value>... @TRACE1 TRACE2 TRACE3 TRACE4, TRACE1 TRACE2 TRACE3 TRACE4 | - | |

:TRACe[:DATA] TRACE1|TRACE2|TRACE3|TRACE4, <block> | <numeric_value>

This command transfers trace data from the controller to the instrument, the query reads trace data out of the instrument.

Example: ":TRAC TRACE1, "+A\$ (A\$: data list in the current format)
"TRAC? TRACE1"

Features: *RST value: -
SCPI: conforming

Modes: A, VA, BTS, MS

The trace data are transferred in the current format (corresponding to the command `FORMat ASCii|REAL`). The device-internal trace memory is addressed using the trace names 'TRACE1' to 'TRACE4'.

The transfer of trace data from the controller to the instrument takes place by indicating the trace name and then the data to be transferred. In ASCII format, these data are values separated by commas. If the transfer takes place using the format real (REAL 32), the data are transferred in block format (see `FORMat` subsystem).

The parameter of the query is the trace name TRACE1 to FINAL4, it indicates which trace memory will be read out.

Saving and recalling trace data together with the device settings to/from the device-internal hard disk or to/from a floppy is controlled via the commands ":MMEMory:STORe:STATe" and ":MMEMory:LOAD:STATe" respectively. Trace data are selected with ":MMEMory:SElect[:ITEM]:ALL" or ":MMEMory:SElect[:ITEM]:TRACe". Trace data in ASCII format (ASCII FILE EXPORT) are exported with the command ":MMEM:STORe:TRACe".

The transfer format for the trace data depends on the instrument setting

Analyzer mode (span >0 and zero span):

500 results are output in the unit selected for display.

Note: *With AUTO PEAK detector, only positive peak values can be read out.
Trace data can be read into instrument with logarithmic display only in dBm, with linear display only in volts.*

FORMAT REAL,32 is to be used as format for binary transmission.

Vector analyzer mode, digital demodulation

The number of data transferred (except for the symbol table) is determined by the following formula

$$\text{number of results} = \text{result length} * \text{points per symbol}$$

Max. 6400 results can be transferred (for example result length 1600, points per symbol 4).

In all cartesian diagrams (MAGNITUDE CAP BUFFER, MAGNITUDE, PHASE, FREQUENCY, REAL/IMAG, EYE[I], EYE[Q], ERROR VECT MAGNITUDE) test data are transferred in the unit selected for display.

FORMAT REAL,32 is to be used for binary transmission.

Note: *In the case of the eye pattern, results are simply superimposed in the display, ie the EYE representation is the same as the REAL/IMAG representation.*

In the polar diagrams (POLAR CONSTELL, POLAR VECTOR) the real and the imaginary component are transferred as a pair for each result.

FORMAT REAL,32 is to be used for binary transmission.

With the SYMB TABLES / ERRORS setting, the displayed symbols can be read out as traces. Trace assignment is as follows:

| | |
|-------------------------|---------|
| Full screen | Trace 1 |
| Split screen, screen A: | Trace 1 |
| Split screen, screen B: | Trace 2 |

One byte (8 bits) is read out for each symbol.

FORMAT UINT,8 is to be used for binary transmission.

Vector analyzer mode, analog demodulation

The number of results transferred depends on the SWEEP TIME and DEMOD BW settings. Max. 5000 and min. 10 points are available. The unit for the results depends on the selected demodulation:

| | |
|----|-----------------|
| AM | unit % |
| FM | unit Hz |
| PM | unit rad or deg |

FORMAT REAL,32 is to be used for binary data transmission.

:TRACe:COPY TRACE1| TRACE2| TRACE3| TRACE4 ,
TRACE1| TRACE2| TRACE3| TRACE4

This command copies data from one trace to another. The second operand designates the source, the first operand the destination of the data to be copied.

Example: " :TRAC:COPY TRACE1 ,TRACE2 "

Features: *RST value:
SCPI: conforming

Modes: A, VA, BTS, MS

This command is an event and therefore has no query and no *RST value assigned.

TRIGger Subsystem

The TRIGger subsystem is used to synchronize instrument actions with events. This makes it possible to control and synchronize the start of a sweep. An external trigger signal can be fed to the connector at the rear panel of the instrument. In split screen mode, a distinction is made between TRIGger1 (screen A) and TRIGger2 (screen B).

| COMMAND | PARAMETERS | UNIT | COMMENT |
|--|--|---|---|
| TRIGger<1 2> [:SEquence] :SOURce | IMMediate LINE EXTernal VIDEo RFPower TV AF | -- | TV only with option TV Demodulator |
| :LEVel [:EXTernal] :VIDeo :AF | <numeric_value> <numeric_value> <numeric_value> | V MV UV PCT PCT HZ DEG RAD | |
| :HOLDoff :SLOPe :VIDeo | <numeric_value> POSitive NEGative | S -- | |
| :FORMat :LPFRame | 525 625 | | Option TV Demodulator |
| :FIEld :SElect | ALL ODD EVEN | | Option TV Demodulator |
| :LINE :NUMBer | <numeric_value> | | Option TV Demodulator |
| :SSIGnal :POLarity | NEGative POSitive | | Option TV Demodulator |
| :SYNChronize :ADJust :FRAME :AUTO | <numeric_value> ONCE | s | Option FSE-K11 Option FSE-K11 & FSE-B7 |
| :SLOT :AUTO :SOURce | <numeric_value> ONCE FRAME TSC | s | Option FSE-K11 Option FSE-K11 & FSE-B7 Option FSE-K11or FSE-K10 & FSE-B7 |

:TRIGger<1|2>[:SEquence]:SOURce IMMediate | LINE | EXTernal | VIDEo | RFPower | TV | AF

This command selects the trigger source for the start of a sweep.

Example: " :TRIG:SOUR EXT "

Features: *RST value: IMMediate
SCPI: conforming

Modes: A, VA, BTS, MS

The value IMMediate corresponds to the "FREE RUN" setting.
Selecting the parameter TV is possible only when the option TV-demodulator is fitted, the parameter AF only in the vector signal analysis mode with analog demodulation.

:TRIGger<1|2>[:SEQUence]:LEVel[:EXTErnal] -5.0 to +5.0V

This command sets the level of the external trigger source.

Example: " :TRIG:LEV 2V"

Features: *RST value: -5.0V
SCPI: conforming

Modes: A, VA, BTS, MS

:TRIGger<1|2>[:SEQUence]:LEVel:VIDeo 0 to 100PCT

This command sets the level of the video trigger source.

Example: " :TRIG:LEV:VID 50PCT"

Features: *RST value: 50 PCT
SCPI: device-specific

Modes: A, VA, BTS, MS

:TRIGger<1|2>[:SEQUence]:LEVel:AF <numeric_value>

This command defines the level of the demodulated trigger source.

The ranges are:

AM-Demod -120 to +120 PCT
FM-Demod -1kHz to +1 kHz
PM-Demod -12 .to.. +12 RAD

Example: " :TRIG:LEV:AF 50PCT"

Features: *RST value: 0 PCT
SCPI: device specific

Mode: VA-A

:TRIGger<1|2>[:SEQUence]:HOLDoff -100s to 100s

This command defines the length of the trigger delay.

Example: " :TRIG:HOLD 500us"

Features: *RST value: 0s
SCPI: conforming

Modes: A, VA

A negative delay time (pretrigger) can be set in the time domain (SPAN < 0 Hz) only. The maximum permissible range and the maximum effective resolution of the pretrigger are limited by the set sweep time (max range= - 499/500 x sweep time; max. resolution = sweep time/500). Pretriggering is not possible when the rms or the average detector is activated.

:TRIGger<1|2>[:SEQuence]:SLOPe POSitive | NEGative

This command selects the slope of the trigger signal.

Example: " :TRIG:SLOP NEG "

Features: *RST value: POSitive
SCPI: conforming

Modes: A, VA, BTS, MS

The selected trigger slope applies to all trigger signal sources.

:TRIGger<1|2>[:SEQuence]:VIDeo::FORMat:LPFRame 525 | 625

This command defines the number of lines per frame to be used (525 or 625 lines)

Example: " :TRIG:VID:FORM:LPFR 525 "

Features: *RST value:
SCPI: conforming

Mode: A-Z

This command is only valid if option FSE-B3, TV Demodulator, is fitted.

:TRIGger<1|2>[:SEQuence]:VIDeo:LINE:NUMBer <numeric value>

This command selects the horizontal synchronizing signal for triggering.

Example: " :TRIG:VID:LINE:NUMB 17 "

Features: *RST value:
SCPI: conforming

Mode: A-Z

The instrument is triggered at the specified line. This command is only valid if option FSE-B3, TV Demodulator is fitted.

:TRIGger<1|2>[:SEQuence]:VIDeo:FIELD:SElect ALL | ODD | EVEN

This command selects the vertical synchronizing signal for triggering.

Example: " :TRIG:VID:FIELD:SEL ALL "

Features: *RST value:
SCPI: conforming

Mode: A-Z

With the parameter ALL, the instrument is triggered when the field is changed, irrespective of the half fields. With ODD, triggering by the first half field, with even, triggering by the second half field is selected. This command is valid only if option FSE-B3, TV Demodulator, is fitted.

:TRIGger<1|2>[:SEQuence]:VIDeo:SSIGnal:POLarity NEGative | POSitive

This command defines the polarity of the video synchronizing signal.

Example: " :TRIG:VID:SSIG:POL NEG "

Features: *RST value:
SCPI: conforming

Mode: A-Z

This command is valid only if option FSE-B3, TV Demodulator, is fitted.

:TRIGger<1|2>[:SEQuence]:SYNChronize:ADJust:FRAMe -100 μ s to 100s

This command defines the correction value for the time offset between the frame trigger and the midamble of the slot selected. The value set is corrected by means of the calculated offsets of the other slots and used as a base value for the correction of all slots.

This correction value is necessary in order to conserve the exact time relation between the trigger event and the midamble of the slot in question in cases where there is no midamble triggering.

Example: " :TRIG:SYNC:ADJ:FRAM 30us "

Features: *RST value: -- (depending on the slot selected)
SCPI: device-specific

Modes: BTS

The numeric suffix in TRIGger<1 | 2> is not significant.

:TRIGger<1|2>[:SEQuence]:SYNChronize:ADJust:FRAMe:AUTO ONCE

This command determines once the correction value for the time offset between the frame trigger and the midamble of the slot selected. The value set is corrected by means of the calculated offsets of the other slots and used as a base value for the correction of all slots.

This correction value is necessary in order to conserve the exact time relation between the trigger event and the midamble of the slot in question in cases where there is no midamble triggering.

Example: " :TRIG:SYNC:ADJ:FRAMe:AUTO ONCE "

Features: *RST value: --
SCPI: device-specific

Modes: BTS

This command is available only in conjunction with option GSM BTS Analyzer, FSE-K11, and with option Vector Signal Analysis, FSE-B7. The numeric suffix in TRIGger<1 | 2> is not significant.

:TRIGger<1|2>[:SEQUence]:SYNChronize:ADJJust:SLOT -100 μ s to 100s

This command defines the correction value for the time offset between the frame trigger and the midamble of the slot selected, without influencing the correction values of the other slots. This correction value is necessary in order to conserve the exact time relation between the trigger event and the midamble of the slot in question in cases where there is no midamble triggering. The value set is corrected by means of the calculated offsets of the other slots and used as a base value for the correction of all slots.

Example: " :TRIG:SYNC:ADJ:SLOT 30us "

Features: *RST value: -- (depending on slot selected)
SCPI: device-specific

Modes: BTS

The numeric suffix in TRIGger<1 | 2> is not significant.

:TRIGger<1|2>[:SEQUence]:SYNChronize:ADJJust:SLOT:AUTO ONCE

This command defines the correction value for the time offset between the frame trigger and the midamble of the slot selected. The value set is corrected by means of the calculated offsets of the other slots and used as a base value for the correction of all slots.

This correction value is necessary in order to conserve the exact time relation between the trigger event and the midamble of the slot in question in cases where there is no midamble triggering.

Example: " :TRIG:SYNC:ADJ:SLOT:AUTO ONCE "

Features: *RST value: --
SCPI: device-specific

Modes: BTS

This command is available only in conjunction with option GSM BTS Analyzer, FSE-K11, and with option Vector Signal Analysis, FSE-B7. The numeric suffix in TRIGger<1 | 2> is not significant.

:TRIGger<1|2>[:SEQUence]:SYNChronize:SOURce FRAME | TSC

This command defines the trigger reference point for measurements in the time domain (carrier power, power vs. time). The frame trigger of the base station or mobile may be selected as well as the relation to the midamble (TSC) of the slot to be measured.

Example: " :TRIG:SYNC:SOURce TSC "

Features: *RST value: FRAME
SCPI: device-specific

Modes: BTS, MS

This command is available only in conjunction with option GSM BTS Analyzer, FSE-K11, or GSM MS Analyzer, FSE-K10. The parameter TSC requires in addition the option Vector Signal Analysis, FSE-B7. The numeric suffix in TRIGger<1 | 2> is not significant.

UNIT Subsystem

The UNIT subsystem is used to switch the basic unit of setting parameters. In split screen mode, a distinction is made between UNIT1 (screen A) and UNIT2 (screen B).

| COMMAND | PARAMETERS | UNIT | COMMENT |
|---|--|------|---------|
| UNIT<1 2> :POWer :PROBe | DBM DBPW WATT DBUV DBMV VOLT DBUA AMPere V W DB PCT UNITLESS DBUV_MHZ DBMV_MHZ DBUA_MHZ DBUV_M DBUA_M DBUV_MMHZ DBUA_MMHZ <Boolean> | | |

:UNIT<1|2>:POWer DBM | DBPW | WATT | DBUV | DBMV | VOLT | DBUA | AMPere | V | W | DB | PCT | UNITLESS | DBUV_MHZ | DBMV_MHZ | DBUA_MHZ | DBUV_M | DBUA_M | DBUV_MMHZ | DBUA_MMHZ

This command selects the default unit for input and output.

Example: " :UNIT:POW DBUV "

Features: *RST value: DBM
SCPI: conforming

Mode: A

:UNIT<1|2>:PROBe ON | OFF

This command determines whether the coding of a probe which is connected to the front panel is taken into consideration (ON) or not (OFF).

Example: " :UNIT:PROB OFF "

Features: *RST value: ON
SCPI: device-specific

Mode: A

Alphabetical List of Commands

In the following, all remote-control commands are listed with their parameters and page numbers. Generally, they are arranged alphabetically according to the keywords of the command.

| Command | Parameter | Page |
|--|--|------|
| :ABORt | | 6.8 |
| :CALCulate<1 2>:CTHReshold | MIN to MAX (depending on current unit) | 6.16 |
| :CALCulate<1 2>:CTHReshold:STATe | ON OFF | 6.16 |
| :CALCulate<1 2>:DELTamarker<1 to 4>:AOFF | | 6.10 |
| :CALCulate<1 2>:DELTamarker<1 to 4>:FUNction:FIXed:RPOint:X | <numeric_value> | 6.13 |
| :CALCulate<1 2>:DELTamarker<1 to 4>:FUNction:FIXed:RPOint:Y | | 6.13 |
| :CALCulate<1 2>:DELTamarker<1 to 4>:FUNction:FIXed:RPOint:Y:OFFSet | <numeric_value> | 6.13 |
| :CALCulate<1 2>:DELTamarker<1 to 4>:FUNction:FIXed[:STATe] | ON OFF | 6.13 |
| :CALCulate<1 2>:DELTamarker<1 to 4>:FUNction:PNOise:RESult? | | 6.14 |
| :CALCulate<1 2>:DELTamarker<1 to 4>:FUNction:PNOise[:STATe] | ON OFF | 6.13 |
| :CALCulate<1 2>:DELTamarker<1 to 4>:MAXimum:APEak | | 6.11 |
| :CALCulate<1 2>:DELTamarker<1 to 4>:MAXimum:LEFT | | 6.12 |
| :CALCulate<1 2>:DELTamarker<1 to 4>:MAXimum:NEXT | | 6.11 |
| :CALCulate<1 2>:DELTamarker<1 to 4>:MAXimum:RIGHT | | 6.11 |
| :CALCulate<1 2>:DELTamarker<1 to 4>:MAXimum[:PEAK] | | 6.11 |
| :CALCulate<1 2>:DELTamarker<1 to 4>:MINimum:LEFT | | 6.12 |
| :CALCulate<1 2>:DELTamarker<1 to 4>:MINimum:NEXT | | 6.12 |
| :CALCulate<1 2>:DELTamarker<1 to 4>:MINimum:RIGHT | | 6.12 |
| :CALCulate<1 2>:DELTamarker<1 to 4>:MINimum[:PEAK] | | 6.12 |
| :CALCulate<1 2>:DELTamarker<1 to 4>:MODE | ABSolute RELative | 6.10 |
| :CALCulate<1 2>:DELTamarker<1 to 4>[:STATe] | ON OFF | 6.9 |
| :CALCulate<1 2>:DELTamarker<1 to 4>:STEP:AUTO | ON OFF | 6.14 |
| :CALCulate<1 2>:DELTamarker<1 to 4>:STEP[:INCRement]] | <numeric value> | 6.14 |
| :CALCulate<1 2>:DELTamarker<1 to 4>:TRACe | 1 to 4 | 6.10 |
| :CALCulate<1 2>:DELTamarker<1 to 4>:X | 0 to MAX (frequency sweep time symbols) | 6.10 |
| :CALCulate<1 2>:DELTamarker<1 to 4>:X:RELative? | | 6.10 |
| :CALCulate<1 2>:DELTamarker<1 to 4>:Y? | | 6.11 |
| :CALCulate<1 2>:DLINe<1 2> | MINimum to MAXimum (depending on current unit) | 6.15 |
| :CALCulate<1 2>:DLINe<1 2>:STATe | ON OFF | 6.15 |
| :CALCulate<1 2>:FEED | 'XTIM:DDEM:MEAS' 'XTIM:DDEM:REF' 'XTIM:DDEM:ERR:MPH' 'XTIM:DDEM:ERR:VECT' 'XTIM:DDEM:SYMB' 'XTIM:AM' 'XTIM:FM' 'XTIM:PM' 'XTIM:AMSummary' 'XTIM:FMSummary' 'XTIM:PMSummary' 'TCAP' | 6.18 |
| :CALCulate<1 2>:FLINe<1 2> | 0 GHz to f_{max} | 6.17 |
| :CALCulate<1 2>:FLINe<1 2>:STATe | ON OFF | 6.17 |

| Command | Parameter | Page |
|---|--|------|
| :CALCulate<1 2>:FORMat | MAGNitude PHASe UPHase RIMag FREQuency IEYE QEYE TEYE FEYE COMP CONS | 6.19 |
| :CALCulate<1 2>:FSK:DEVIation:REFerence | <numeric_value> | 6.19 |
| :CALCulate<1 2>:LIMit<1 to 8>:ACPowEr:ACHannel | 0 to 100 dB, 0 to 100 dB | 6.33 |
| :CALCulate<1 2>:LIMit<1 to 8>:ACPowEr:ACHannel:RESult? | | 6.34 |
| :CALCulate<1 2>:LIMit<1 to 8>:ACPowEr:ACHannel:STATe | ON OFF | 6.34 |
| :CALCulate<1 2>:LIMit<1 to 8>:ACPowEr:ALTErnate<1 2> | 0 to 100 DB, 0 to 100 DB | 6.34 |
| :CALCulate<1 2>:LIMit<1 to 8>:ACPowEr:ALTErnate<1 2>:RESult? | | 6.35 |
| :CALCulate<1 2>:LIMit<1 to 8>:ACPowEr:ALTErnate<1 2>:STATe | ON OFF | 6.35 |
| :CALCulate<1 2>:LIMit<1 to 8>:ACPowEr[:STATe] | ON OFF | 6.33 |
| :CALCulate<1 2>:LIMit<1 to 8>:ACTive? | | 6.21 |
| :CALCulate<1 2>:LIMit<1 to 8>:BURSt:MACCuracy? | | 6.30 |
| :CALCulate<1 2>:LIMit<1 to 8>:BURSt:PFERror? | | 6.29 |
| :CALCulate<1 2>:LIMit<1 to 8>:BURSt:POWEr? | | 6.29 |
| :CALCulate<1 2>:LIMit<1 to 8>:BURSt:PTEMplate? | | 6.29 |
| :CALCulate<1 2>:LIMit<1 to 8>:CATalog? | | 6.22 |
| :CALCulate<1 2>:LIMit<1 to 8>:CLEAr[:IMMediate] | | 6.27 |
| :CALCulate<1 2>:LIMit<1 to 8>:COMMEnt | <string> | 6.27 |
| :CALCulate<1 2>:LIMit<1 to 8>:CONTRol[:DATA] | <numeric_value>, <numeric_value>. | 6.22 |
| :CALCulate<1 2>:LIMit<1 to 8>:CONTRol:DOMain | FREQuency TIME | 6.23 |
| :CALCulate<1 2>:LIMit<1 to 8>:CONTRol:MODE | RELative ABSolute | 6.23 |
| :CALCulate<1 2>:LIMit<1 to 8>:CONTRol:OFFSet | <numeric_value> | 6.23 |
| :CALCulate<1 2>:LIMit<1 to 8>:CONTRol:SHIFt | <numeric_value> | 6.23 |
| :CALCulate<1 2>:LIMit<1 to 8>:CONTRol:SPACing | LINear < LOGarithmic | 6.24 |
| :CALCulate<1 2>:LIMit<1 to 8>:CONTRol:UNIT[:TIME] | S SYM | 6.23 |
| :CALCulate<1 2>:LIMit<1 to 8>:COPIY | 1 to 8 <name> | 6.28 |
| :CALCulate<1 2>:LIMit<1 to 8>:DELEte | | 6.28 |
| :CALCulate<1 2>:LIMit<1 to 8>:FAIL? | | 6.27 |
| :CALCulate<1 2>:LIMit<1 to 8>:LOWEr[:DATA] | <numeric_value> | 6.25 |
| :CALCulate<1 2>:LIMit<1 to 8>:LOWEr:MARGin | <numeric_value> | 6.26 |
| :CALCulate<1 2>:LIMit<1 to 8>:LOWEr:MODE | RELative ABSolute | 6.26 |
| :CALCulate<1 2>:LIMit<1 to 8>:LOWEr:OFFSet | <numeric_value> | 6.26 |
| :CALCulate<1 2>:LIMit<1 to 8>:LOWEr:SHIFt | <numeric_value> | 6.26 |
| :CALCulate<1 2>:LIMit<1 to 8>:LOWEr:SPACing | LINear LOGarithmic | 6.27 |
| :CALCulate<1 2>:LIMit<1 to 8>:LOWEr:STATe | ON OFF | 6.26 |
| :CALCulate<1 2>:LIMit<1 to 8>:MARGin | 0 to 100DB | 6.33 |
| :CALCulate<1 2>:LIMit<1 to 8>:NAME | 1 to 8 <string> | 6.28 |
| :CALCulate<1 2>:LIMit<1 to 8>:SPECTrum:MODulation:EXCEptions? | ARFCn TXBand RXBand COMBined DCSRx1800 | 6.31 |
| :CALCulate<1 2>:LIMit<1 to 8>:SPECTrum:MODulation:FAILs? | ARFCn TXBand RXBand COMBined DCSRx1800 | 6.31 |
| :CALCulate<1 2>:LIMit<1 to 8>:SPECTrum:MODulation? | ARFCn TXBand RXBand COMBined DCSRx1800 | 6.30 |
| :CALCulate<1 2>:LIMit<1 to 8>:SPECTrum:SWITChing:FAILs? | | 6.32 |
| :CALCulate<1 2>:LIMit<1 to 8>:SPECTrum:SWITChing? | | 6.32 |
| :CALCulate<1 2>:LIMit<1 to 8>:SPURious:FAILs? | TXBand OTXBand RXBand IDLeband | 6.33 |

| Command | Parameter | Page |
|---|--|------|
| :CALCulate<1 2>:LIMit<1 to 8>:SPURious? | ARFCn TXBand RXBand IDLeband | 6.32 |
| :CALCulate<1 2>:LIMit<1 to 8>:STATe | ON OFF | 6.22 |
| :CALCulate<1 2>:LIMit<1 to 8>:TRACe | 1 to 4 | 6.21 |
| :CALCulate<1 2>:LIMit<1 to 8>:UNIT | DBM DBPW DBPT WATT DBUV DBMV VOLT DBUA AMPere DB DBUV_MHZ DBMV_MHZ DBUA_MHZ DBUV_M DBUA_M DBUV_MHZ DBUA_MHZ UNITLESS | 6.22 |
| :CALCulate<1 2>:LIMit<1 to 8>:UPPer[:DATA] | <numeric_value>, <numeric_value> | 6.24 |
| :CALCulate<1 2>:LIMit<1 to 8>:UPPer:MARGin | <numeric_value> | 6.24 |
| :CALCulate<1 2>:LIMit<1 to 8>:UPPer:MODE | RELative ABSolute | 6.25 |
| :CALCulate<1 2>:LIMit<1 to 8>:UPPer:OFFSet | <numeric_value> | 6.24 |
| :CALCulate<1 2>:LIMit<1 to 8>:UPPer:SHIFt | <numeric_value> | 6.25 |
| :CALCulate<1 2>:LIMit<1 to 8>:UPPer:SPACing | LINear LOGarithmic | 6.25 |
| :CALCulate<1 2>:LIMit<1 to 8>:UPPer:STATe | ON OFF | 6.24 |
| :CALCulate<1 2>:MARKer<1 to 4>:AOFF | | 6.39 |
| :CALCulate<1 2>:MARKer<1 to 4>:COUNT | ON OFF | 6.40 |
| :CALCulate<1 2>:MARKer<1 to 4>:COUNT:FREQuency? | | 6.40 |
| :CALCulate<1 2>:MARKer<1 to 4>:COUNT:RESolution | 0.1 1 10 100 1000 10000 Hz | 6.40 |
| :CALCulate<1 2>:MARKer<1 to 4>:COUPled[:STATe] | ON OFF | 6.40 |
| :CALCulate<1 2>:MARKer<1 to 4>:FUNCTion:ADEMod:AFREquency[:RESult]? | | 6.48 |
| :CALCulate<1 2>:MARKer<1 to 4>:FUNCTion:ADEMod:AM[:RESult]? | PPEak MPEak MIDDLE RMS | 6.47 |
| :CALCulate<1 2>:MARKer<1 to 4>:FUNCTion:ADEMod:CARRier[:RESult]? | | 6.49 |
| :CALCulate<1 2>:MARKer<1 to 4>:FUNCTion:ADEMod:FERRor[:RESult]? | | 6.48 |
| :CALCulate<1 2>:MARKer<1 to 4>:FUNCTion:ADEMod:FM[:RESult]? | PPEak MPEak MIDDLE RMS RDEV | 6.48 |
| :CALCulate<1 2>:MARKer<1 to 4>:FUNCTion:ADEMod:PM[:RESult]? | PPEak MPEak MIDDLE RMS | 6.48 |
| :CALCulate<1 2>:MARKer<1 to 4>:FUNCTion:ADEMod:SINad:RESult? | | 6.49 |
| :CALCulate<1 2>:MARKer<1 to 4>:FUNCTion:ADEMod:SINad[:STATe] | ON OFF | 6.49 |
| :CALCulate<1 2>:MARKer<1 to 4>:FUNCTion:CENTER: | ON OFF | 6.59 |
| :CALCulate<1 2>:MARKer<1 to 4>:FUNCTion:CSTep: | ON OFF | 6.59 |
| :CALCulate<1 2>:MARKer<1 to 4>:FUNCTion:DDEMod:RESult? | MERM MEPK MEPS PERM PEPK PEPS EVRM EVPK EVPS IQOF IQIM ADR FERR FEPK RHO DEV FSRM FSPK FSPS DTTS | 6.50 |
| :CALCulate<1 2>:MARKer<1 to 4>:FUNCTion:DEModulation:HOLDoff | 10ms to 1000s | 6.46 |
| :CALCulate<1 2>:MARKer<1 to 4>:FUNCTion:DEModulation:SElect | AM FM | 6.45 |
| :CALCulate<1 2>:MARKer<1 to 4>:FUNCTion:DEModulation[:STATe] | ON OFF | 6.46 |
| :CALCulate<1 2>:MARKer<1 to 4>:FUNCTion:MSTep | | 6.60 |
| :CALCulate<1 2>:MARKer<1 to 4>:FUNCTion:NDBDown | <numeric_value> | 6.44 |
| :CALCulate<1 2>:MARKer<1 to 4>:FUNCTion:NDBDown:FREQuency? | | 6.44 |
| :CALCulate<1 2>:MARKer<1 to 4>:FUNCTion:NDBDown:RESult? | | 6.44 |
| :CALCulate<1 2>:MARKer<1 to 4>:FUNCTion:NDBDown:STATe | ON OFF | 6.44 |
| :CALCulate<1 2>:MARKer<1 to 4>:FUNCTion:NOISe:RESult? | | 6.45 |
| :CALCulate<1 2>:MARKer<1 to 4>:FUNCTion:NOISe[:STATe] | ON OFF | 6.45 |
| :CALCulate<1 2>:MARKer<1 to 4>:FUNCTion:POWer:CFILter | ON OFF | 6.52 |

| Command | Parameter | Page |
|---|--|------|
| :CALCulate<1 2>:MARKer<1 to 4>:FUNctio:n:POWer:PRESet | NADC TETRA PDC PHS CDPD FWCDMA RWCDMA FW3Gppcdma RW3Gppcdma M2CDma D2CDma F8CDma R8CDma F19Cdma R19Cdma NONE FO8Cdma RO8Cdma FO19CDMA RO19CDMA TCDMa | 6.52 |
| :CALCulate<1 2>:MARKer<1 to 4>:FUNctio:n:POWer:RESult? | ACPower CPOWer OBANdwidth OBWidth CN CN0 | 6.51 |
| :CALCulate<1 2>:MARKer<1 to 4>:FUNctio:n:POWer:SELEct? | ACPower CPOWer OBANdwidth OBWidth CN CN0 | 6.50 |
| :CALCulate<1 2>:MARKer<1 to 4>:FUNctio:n:POWer[:STATe] | OFF | 6.51 |
| :CALCulate<1 2>:MARKer<1 to 4>:FUNctio:n:REFerence: | ON OFF | 6.60 |
| :CALCulate<1 2>:MARKer<1 to 4>:FUNctio:n:SFACtor | (60dB/3dB) (60dB/6dB) | 6.46 |
| :CALCulate<1 2>:MARKer<1 to 4>:FUNctio:n:SFACtor:FREQuency? | | 6.47 |
| :CALCulate<1 2>:MARKer<1 to 4>:FUNctio:n:SFACtor:RESult? | | 6.46 |
| :CALCulate<1 2>:MARKer<1 to 4>:FUNctio:n:SFACtor:STATe | ON OFF | 6.46 |
| :CALCulate<1 2>:MARKer<1 to 4>:FUNctio:n:STARt | | 6.60 |
| :CALCulate<1 2>:MARKer<1 to 4>:FUNctio:n:STOP | | 6.60 |
| :CALCulate<1 2>:MARKer<1 to 4>:FUNctio:n:STRack[:STATe] | ON OFF | 6.47 |
| :CALCulate<1 2>:MARKer<1 to 4>:FUNctio:n:SUMMary:AOFF | | 6.59 |
| :CALCulate<1 2>:MARKer<1 to 4>:FUNctio:n:SUMMary:AVERAge | ON OFF | 6.59 |
| :CALCulate<1 2>:MARKer<1 to 4>:FUNctio:n:SUMMary:MAXimum:AVER:RESult? | | 6.53 |
| :CALCulate<1 2>:MARKer<1 to 4>:FUNctio:n:SUMMary:MAXimum:PHOLd:RES? | | 6.53 |
| :CALCulate<1 2>:MARKer<1 to 4>:FUNctio:n:SUMMary:MAXimum:RESult? | | 6.53 |
| :CALCulate<1 2>:MARKer<1 to 4>:FUNctio:n:SUMMary:MAXimum[:STATe] | ON OFF | 6.53 |
| :CALCulate<1 2>:MARKer<1 to 4>:FUNctio:n:SUMMary:MEAN:AVERAge:RESult? | | 6.58 |
| :CALCulate<1 2>:MARKer<1 to 4>:FUNctio:n:SUMMary:MEAN:PHOLd:RESult? | | 6.58 |
| :CALCulate<1 2>:MARKer<1 to 4>:FUNctio:n:SUMMary:MEAN:RESult? | | 6.58 |
| :CALCulate<1 2>:MARKer<1 to 4>:FUNctio:n:SUMMary:MEAN[:STATe] | ON OFF | 6.58 |
| :CALCulate<1 2>:MARKer<1 to 4>:FUNctio:n:SUMMary:MIDDLE:AVERAge:RESult? | | 6.56 |
| :CALCulate<1 2>:MARKer<1 to 4>:FUNctio:n:SUMMary:MIDDLE:PHOLd:RESult? | | 6.56 |
| :CALCulate<1 2>:MARKer<1 to 4>:FUNctio:n:SUMMary:MIDDLE:RESult? | | 6.56 |
| :CALCulate<1 2>:MARKer<1 to 4>:FUNctio:n:SUMMary:MIDDLE[:STATe] | ON OFF | 6.56 |
| :CALCulate<1 2>:MARKer<1 to 4>:FUNctio:n:SUMMary:MPEak:AVERAge:RESult? | | 6.55 |
| :CALCulate<1 2>:MARKer<1 to 4>:FUNctio:n:SUMMary:MPEak:PHOLd:RESult? | | 6.55 |
| :CALCulate<1 2>:MARKer<1 to 4>:FUNctio:n:SUMMary:MPEak:RESult? | | 6.55 |
| :CALCulate<1 2>:MARKer<1 to 4>:FUNctio:n:SUMMary:MPEak[:STATe] | ON OFF | 6.55 |
| :CALCulate<1 2>:MARKer<1 to 4>:FUNctio:n:SUMMary:PHOLd | ON OFF | 6.59 |
| :CALCulate<1 2>:MARKer<1 to 4>:FUNctio:n:SUMMary:PPEak:AVERAge:RESult? | | 6.54 |
| :CALCulate<1 2>:MARKer<1 to 4>:FUNctio:n:SUMMary:PPEak:PHOLd:RESult? | | 6.54 |
| :CALCulate<1 2>:MARKer<1 to 4>:FUNctio:n:SUMMary:PPEak:RESult? | | 6.54 |
| :CALCulate<1 2>:MARKer<1 to 4>:FUNctio:n:SUMMary:PPEak[:STATe] | ON OFF | 6.54 |
| :CALCulate<1 2>:MARKer<1 to 4>:FUNctio:n:SUMMary:RMS:AVERAge:RESult? | | 6.57 |
| :CALCulate<1 2>:MARKer<1 to 4>:FUNctio:n:SUMMary:RMS:PHOLd:RESult? | | 6.57 |
| :CALCulate<1 2>:MARKer<1 to 4>:FUNctio:n:SUMMary:RMS:RESult? | | 6.57 |
| :CALCulate<1 2>:MARKer<1 to 4>:FUNctio:n:SUMMary:RMS[:STATe] | ON OFF | 6.57 |
| :CALCulate<1 2>:MARKer<1 to 4>:FUNctio:n:SUMMary:STATe | ON OFF | 6.52 |

| Command | Parameter | Page |
|--|--|------|
| :CALCulate<1 2>:MARKer<1 to 4>:FUNCTION:ZOOM | <numeric_value> | 6.45 |
| :CALCulate<1 2>:MARKer<1 to 4>:LOEXclude | ON OFF | 6.40 |
| :CALCulate<1 2>:MARKer<1 to 4>:MAXimum:APEak | | 6.41 |
| :CALCulate<1 2>:MARKer<1 to 4>:MAXimum:LEFT | | 6.42 |
| :CALCulate<1 2>:MARKer<1 to 4>:MAXimum:NEXT | | 6.41 |
| :CALCulate<1 2>:MARKer<1 to 4>:MAXimum:RIGHT | | 6.41 |
| :CALCulate<1 2>:MARKer<1 to 4>:MAXimum[:PEAK] | | 6.41 |
| :CALCulate<1 2>:MARKer<1 to 4>:MINimum:LEFT | | 6.42 |
| :CALCulate<1 2>:MARKer<1 to 4>:MINimum:NEXT | | 6.42 |
| :CALCulate<1 2>:MARKer<1 to 4>:MINimum:RIGHT | | 6.42 |
| :CALCulate<1 2>:MARKer<1 to 4>:MINimum[:PEAK] | | 6.42 |
| :CALCulate<1 2>:MARKer<1 to 4>:PEXCursion | <numeric_value> | 6.43 |
| :CALCulate<1 2>:MARKer<1 to 4>:READout | MPHase RIMaginary | 6.43 |
| :CALCulate<1 2>:MARKer<1 to 4>:STEP:AUTO | ON OFF | 6.43 |
| :CALCulate<1 2>:MARKer<1 to 4>:STEP[:INCRement] | <numeric_value> | 6.43 |
| :CALCulate<1 2>:MARKer<1 to 4>:TRACe | 1 to 4 | 6.39 |
| :CALCulate<1 2>:MARKer<1 to 4>:X | 0 to MAX (frequency sweep time symbols) | 6.39 |
| :CALCulate<1 2>:MARKer<1 to 4>:X:SLIMits[:STATe] | ON OFF | 6.39 |
| :CALCulate<1 2>:MARKer<1 to 4>:Y? | | 6.41 |
| :CALCulate<1 2>:MARKer<1 to 4>[:STATe] | ON OFF | 6.39 |
| :CALCulate<1 2>:MATH<1 to 4>:STATe | ON OFF | 6.61 |
| :CALCulate<1 2>:MATH<1 to 4>[:EXPRession][:DEFine] | <expr> | 6.61 |
| :CALCulate<1 2>:RLINe | MINimum to MAXimum (depending on current unit) | 6.16 |
| :CALCulate<1 2>:RLINe:STATe | ON OFF | 6.17 |
| :CALCulate<1 2>:THReshold | MINimum to MAXimum (depending on current unit) | 6.16 |
| :CALCulate<1 2>:THReshold:STATe | ON OFF | 6.16 |
| :CALCulate<1 2>:TLINe<1 2> | 0 to 1000s | 6.17 |
| :CALCulate<1 2>:TLINe<1 2>:STATe | ON OFF | 6.17 |
| :CALCulate<1 2>:UNIT:ANGLE | DEG RAD | 6.62 |
| :CALCulate<1 2>:UNIT:POWer | DBM V W DB PCT UNITLESS DBPT DBPW WATT DBUV DBMV VOLT DBUA AMPere DBUV_MHZ DBMV_MHZ DBUA_MHZ DBUV_M DBUA_M DBUV_MMHZ DBUA_MMHZ | 6.62 |
| :CALCulate<1 2>:X:UNIT:TIME | S SYM | 6.62 |
| :CALibration:BANDwidth BWIDth[:RESolution]? | | 6.63 |
| :CALibration:IQ? | | 6.63 |
| :CALibration:LDETEctor? | | 6.64 |
| :CALibration:LOSuppression? | | 6.64 |
| :CALibration:PPEak? | | 6.64 |
| :CALibration:SHORT? | | 6.64 |
| :CALibration:STATe | ON OFF | 6.64 |
| :CALibration[:ALL] | | 6.63 |
| :CONFigure:BURSt:MACCuracy:CONDition | NORMal EXTReMe | 6.74 |

| Command | Parameter | Page |
|--|---|------|
| :CONFigure:BURSt:MACCuracy:COUNT | 1 to 1000 | 6.74 |
| :CONFigure:BURSt:MACCuracy[:IMMEDIATE] | | 6.74 |
| :CONFigure:BURSt:PFERror:CONDition | NORMal EXTReMe | 6.74 |
| :CONFigure:BURSt:PFERror:COUNT | 1 to 1000 | 6.73 |
| :CONFigure:BURSt:PFERror[:IMMEDIATE] | | 6.73 |
| :CONFigure:BURSt:POWer:CONDition | NORMal EXTReMe | 6.75 |
| :CONFigure:BURSt:POWer:COUNT | 1 to 1000 | 6.75 |
| :CONFigure:BURSt:POWer[:IMMEDIATE] | | 6.75 |
| :CONFigure:BURSt:PTEMplate:COUNT | 1 to 1000 | 6.75 |
| :CONFigure:BURSt:PTEMplate:SElect | FULL TOP RISing FALLing | 6.76 |
| :CONFigure:BURSt:PTEMplate[:IMMEDIATE] | | 6.75 |
| :CONFigure:BURSt:REFerence:AUTO | ON OFF | 6.76 |
| :CONFigure:SPEctrum:MODulation:COUNT | 1 to 1000 | 6.85 |
| :CONFigure:SPEctrum:MODulation:RANGe | ARFCn TXBand RXBand COMBined DCSRx1800 G8Rxband PCSRx1900 | 6.86 |
| :CONFigure:SPEctrum:MODulation:TGATe | ON OFF | 6.86 |
| :CONFigure:SPEctrum:MODulation[:IMMEDIATE] | | 6.85 |
| :CONFigure:SPEctrum:SWITching:COUNT | 1 to 1000 | 6.86 |
| :CONFigure:SPEctrum:SWITching[:IMMEDIATE] | | 6.86 |
| :CONFigure:SPURious:ANTenna | CONDucted RADiated | 6.88 |
| :CONFigure:SPURious:COUNT | 1 to 1000 | 6.87 |
| :CONFigure:SPURious:COUNT:RXBand | 1 to 1000 | 6.87 |
| :CONFigure:SPURious:RANGe | TXBand OTXBand RXBand IDLeband COMBined | 6.88 |
| :CONFigure:SPURious:STEP:COUNT? | | 6.88 |
| :CONFigure:SPURious:STEP<1 to 26> | ON OFF | 6.88 |
| :CONFigure:SPURious[:IMMEDIATE] | | 6.87 |
| :CONFigure[:BTS]: STYPe | NORMal MICRo PICO | 6.72 |
| :CONFigure[:BTS]:ARFCn | 1 to 124 (P-GSM phase I/II) 0 to 124, 975 to 1023 (E-GSM) 0 to 124, 955 to 1023 (R-GSM) 512 to 885 (DCS1800 phase I/II/II+) 512 to 810 (PCS1900) 128 to 251 (GSM850) | 6.66 |
| :CONFigure[:BTS]:ARFCn:AUTO | ONCE | 6.66 |
| :CONFigure[:BTS]:CHANnel:SFH | ON OFF | 6.70 |
| :CONFigure[:BTS]:CHANnel:SLOT | 0 to 7 | 6.70 |
| :CONFigure[:BTS]:CHANnel:SLOT:AUTO | ONCE | 6.70 |
| :CONFigure[:BTS]:CHANnel:TSC | 0 to 7 | 6.71 |
| :CONFigure[:BTS]:CHANnel:TSC:AUTO | ON OFF | 6.71 |
| :CONFigure[:BTS]:COSiting | ON OFF | 6.71 |
| :CONFigure[:BTS]:LIMit:EVMPeak | <numeric_value> | 6.67 |
| :CONFigure[:BTS]:LIMit:EVMRms | <numeric_value> | 6.67 |
| :CONFigure[:BTS]:LIMit:FREquency | <numeric_value> | 6.68 |
| :CONFigure[:BTS]:LIMit:OSUPpress | <numeric_value> | 6.67 |
| :CONFigure[:BTS]:LIMit:PERCentile | <numeric_value> | 6.68 |
| :CONFigure[:BTS]:LIMit:PPEak | <numeric_value> | 6.67 |
| :CONFigure[:BTS]:LIMit:PRMS | <numeric_value> | 6.67 |

| Command | Parameter | Page |
|---------------------------------------|---|------|
| :CONFigure[:BTS]:LIMit:STANdard | ON OFF | 6.68 |
| :CONFigure[:BTS]:MEASurement? | | 6.66 |
| :CONFigure[:BTS]:MTYPE | GMSK EDGE | 6.72 |
| :CONFigure[:BTS]:NETWork:PHASe | 1 2 [,PLUS] | 6.71 |
| :CONFigure[:BTS]:NETWork[:TYPE] | PGSM PGSM900 EGSM EGSM900 DCS GSM1800 PCS GSM1900 RGSM RGSM900 GSM850 | 6.71 |
| :CONFigure[:BTS]:POWer:CLASs | 1 to 8 1 to 4 M1 M2 M3 P1 | 6.68 |
| :CONFigure[:BTS]:POWer:COUPlEd | ON OFF | 6.68 |
| :CONFigure[:BTS]:POWer:DYNamic | 0 to 15 | 6.69 |
| :CONFigure[:BTS]:POWer:EXPeCted | <numeric_value> | 6.69 |
| :CONFigure[:BTS]:POWer:LIMit | <numeric_value> | 6.69 |
| :CONFigure[:BTS]:POWer:SINGle:CLEar | | 6.70 |
| :CONFigure[:BTS]:POWer:SINGle[:STATe] | ON OFF | 6.69 |
| :CONFigure[:BTS]:POWer:STATic | 0 to 6 | 6.69 |
| :CONFigure[:BTS]:PRESet | | 6.72 |
| :CONFigure[:BTS]:SWEeptime | STANdard AUTO | 6.72 |
| :CONFigure[:BTS]:TXSupp | ON OFF | 6.72 |
| :CONFigure[:MS]: MTYPE | GMSK EDGE | 6.84 |
| :CONFigure[:MS]:ARFCn | 1 to 124 (P-GSM phase I/II) 0 to 124, 975 to 1023 (E-GSM) 0 to 124, 955 to 1023 (R-GSM) 512 to 885 (DCS1800 phase I/II/II+) 512 to 810 (PCS1900) 128 to 810 (GSM850) | 6.78 |
| :CONFigure[:MS]:ARFCn:AUTO | ONCE | 6.78 |
| :CONFigure[:MS]:CHANnel:SFH | ON OFF | 6.82 |
| :CONFigure[:MS]:CHANnel:TSC | 0 to 7 | 6.82 |
| :CONFigure[:MS]:LIMit:EVMPeak | <numeric_value> | 6.79 |
| :CONFigure[:MS]:LIMit:EVMRms | <numeric_value> | 6.79 |
| :CONFigure[:MS]:LIMit:FREQUency | <numeric_value> | 6.80 |
| :CONFigure[:MS]:LIMit:OSUPpress | <numeric_value> | 6.79 |
| :CONFigure[:MS]:LIMit:PERCentile | <numeric_value> | 6.80 |
| :CONFigure[:MS]:LIMit:PPEak | <numeric_value> | 6.79 |
| :CONFigure[:MS]:LIMit:PRMS | <numeric_value> | 6.79 |
| :CONFigure[:MS]:LIMit:STANdard | ON OFF | 6.80 |
| :CONFigure[:MS]:MEASurement? | | 6.78 |
| :CONFigure[:MS]:NETWork:PHASe | 1 2 [,PLUS] | 6.83 |
| :CONFigure[:MS]:NETWork[:TYPE] | PGSM PGSM900 EGSM EGSM900 DCS GSM1800 PCS GSM1900 RGSM RGSM900 GSM850 | 6.83 |
| :CONFigure[:MS]:POWer:CLASs | <num_value> EG1 EG2 EG3 | 6.80 |
| :CONFigure[:MS]:POWer:COUPlEd | ON OFF | 6.81 |
| :CONFigure[:MS]:POWer:EXPeCted | <numeric_value> | 6.81 |
| :CONFigure[:MS]:POWer:LEVel | 0 to 31 | 6.81 |
| :CONFigure[:MS]:POWer:LIMit | <numeric_value> | 6.81 |
| :CONFigure[:MS]:POWer:SINGle:CLEar | | 6.82 |
| :CONFigure[:MS]:POWer:SINGle[:STATe] | ON OFF | 6.82 |

| Command | Parameter | Page |
|--|---|-------|
| :CONFigure[:MS]:POWer:SMALl | ON OFF | 6.82 |
| :CONFigure[:MS]:PRESet | | 6.83 |
| :CONFigure[:MS]:SWEeptime | STANdard AUTO | 6.84 |
| :CONFigure[:MS]:TXSupp | ON OFF | 6.83 |
| :DIAGnostic:INFO:CCOut:ATTenuation<1 2 3>? | | 6.90 |
| :DIAGnostic:SERVice:FUNcTion | <num_value>,<num_value>... | 6.89 |
| :DIAGnostic:SERVice:INPut[:SElect] | CALibration RF | 6.89 |
| :DIAGnostic:SERVice:NSOource | ON OFF | 6.89 |
| :DISPlay:ANNotation:FREQuency | ON OFF | 6.92 |
| :DISPlay:CMAP<1 to 13>:DEFault | | 6.93 |
| :DISPlay:CMAP<1 to 13>:HSL | 0.0 to 100.0 (tint), 0.0 to 100.0 (saturation), 0.0 to 100.0 (brightness) | 6.93 |
| :DISPlay:CMAP<1 to 13>:PDEFined | <color> | 6.93 |
| :DISPlay:FORMat | SINGle SPLit | 6.92 |
| :DISPlay:LOGO | ON OFF | 6.92 |
| :DISPlay:PROGram[:MODE] | ON OFF | 6.92 |
| :DISPlay:PSAVe:HOLDoff | | 6.100 |
| :DISPlay:PSAVe:STATe] | ON OFF | 6.100 |
| :DISPlay[:WINDow<1 2>]:MINFo | ON OFF | 6.94 |
| :DISPlay[:WINDow<1 2>]:SElect | ' | 6.94 |
| :DISPlay[:WINDow<1 2>]:TEXT[:DATA] | <string> | 6.94 |
| :DISPlay[:WINDow<1 2>]:TEXT:STATe | ON OFF | 6.94 |
| :DISPlay[:WINDow<1 2>]:TIME | ON OFF | 6.95 |
| :DISPlay[:WINDow<1 2>]:TRACe<1 to 4>:EYE:COUNT | 1 to result length | 6.100 |
| :DISPlay[:WINDow<1 2>]:TRACe<1 to 4>:MODE | WRITe VIEW AVERAge MAXHold MINHold | 6.98 |
| :DISPlay[:WINDow<1 2>]:TRACe<1 to 4>:MODE:ANALog | ON OFF | 6.99 |
| :DISPlay[:WINDow<1 2>]:TRACe<1 to 4>:MODE:CWRite | ON OFF | 6.99 |
| :DISPlay[:WINDow<1 2>]:TRACe<1 to 4>:MODE:HCONtinuous | ON OFF | 6.99 |
| :DISPlay[:WINDow<1 2>]:TRACe<1 to 4>[:STATe] | ON OFF | 6.99 |
| :DISPlay[:WINDow<1 2>]:TRACe<1 to 4>:SYMBol | DOTS BARS OFF | 6.100 |
| :DISPlay[:WINDow<1 2>]:TRACe<1 to 4>:X[:SCALE]:RVALue | <numeric_value> | 6.95 |
| :DISPlay[:WINDow<1 2>]:TRACe<1 to 4>:X[:SCALE]:ZOOM | ON OFF | 6.95 |
| :DISPlay[:WINDow<1 2>]:TRACe<1 to 4>:X[:SCALE]:ZOOM[:FREQuency]:CENTer | <numeric_value> | 6.96 |
| :DISPlay[:WINDow<1 2>]:TRACe<1 to 4>:X[:SCALE]:ZOOM[:FREQuency]:START | <numeric_value> | 6.95 |
| :DISPlay[:WINDow<1 2>]:TRACe<1 to 4>:X[:SCALE]:ZOOM[:FREQuency]:STOP | <numeric_value> | 6.95 |
| :DISPlay[:WINDow<1 2>]:TRACe<1 to 4>:Y:SPACing | LINear LOGarithmic PERCent | 6.98 |
| :DISPlay[:WINDow<1 2>]:TRACe<1 to 4>:Y[:SCALE] | 10dB to 200dB | 6.96 |
| :DISPlay[:WINDow<1 2>]:TRACe<1 to 4>:Y[:SCALE]:MODE | ABSolute RELative | 6.96 |
| :DISPlay[:WINDow<1 2>]:TRACe<1 to 4>:Y[:SCALE]:PDIVision | <numeric_value> | 6.98 |
| :DISPlay[:WINDow<1 2>]:TRACe<1 to 4>:Y[:SCALE]:RLEVel | -200dBm to 200dBm | 6.96 |
| :DISPlay[:WINDow<1 2>]:TRACe<1 to 4>:Y[:SCALE]:RLEVel:OFFSet | -200dB to 200dB | 6.97 |
| :DISPlay[:WINDow<1 2>]:TRACe<1 to 4>:Y[:SCALE]:RPOStion | 0 to 100 PCT | 6.98 |
| :DISPlay[:WINDow<1 2>]:TRACe<1 to 4>:Y[:SCALE]:RVALue | <numeric_value> | 6.97 |
| :DISPlay[:WINDow<1 2>]:TRACe<1 to 4>:Y[:SCALE]:RVALue:AUTO | ON OFF | 6.97 |
| :FETCh:BURSt:FERRor:AVERAge? | | 6.104 |

| Command | Parameter | Page |
|--|--|-------|
| :FETCh:BURSt:FERRor:MAXimum? | | 6.104 |
| :FETCh:BURSt:FERRor:STATus? | | 6.104 |
| :FETCh:BURSt:MACCuracy:FREQuency:AVERage? | | 6.110 |
| :FETCh:BURSt:MACCuracy:FREQuency:MAXimum? | | 6.110 |
| :FETCh:BURSt:MACCuracy:FREQuency:STATus? | | 6.110 |
| :FETCh:BURSt:MACCuracy:OSUPpress:AVERage? | | 6.108 |
| :FETCh:BURSt:MACCuracy:OSUPpress:MAXimum? | | 6.109 |
| :FETCh:BURSt:MACCuracy:OSUPpress:STATus? | | 6.108 |
| :FETCh:BURSt:MACCuracy:PEAK:AVERage? | | 6.108 |
| :FETCh:BURSt:MACCuracy:PEAK:MAXimum? | | 6.108 |
| :FETCh:BURSt:MACCuracy:PEAK:STATus? | | 6.107 |
| :FETCh:BURSt:MACCuracy:PERCentile:AVERage? | | 6.109 |
| :FETCh:BURSt:MACCuracy:PERCentile:MAXimum? | | 6.109 |
| :FETCh:BURSt:MACCuracy:PERCentile:STATus? | | 6.109 |
| :FETCh:BURSt:MACCuracy:RMS:AVERage? | | 6.107 |
| :FETCh:BURSt:MACCuracy:RMS:MAXimum? | | 6.107 |
| :FETCh:BURSt:MACCuracy:RMS:STATus? | | 6.107 |
| :FETCh:BURSt:PERRor:PEAK:AVERage? | | 6.103 |
| :FETCh:BURSt:PERRor:PEAK:MAXimum? | | 6.103 |
| :FETCh:BURSt:PERRor:PEAK:STATus? | | 6.103 |
| :FETCh:BURSt:PERRor:RMS:AVERage? | | 6.102 |
| :FETCh:BURSt:PERRor:RMS:MAXimum? | | 6.102 |
| :FETCh:BURSt:PERRor:RMS:STATus? | | 6.102 |
| :FETCh:BURSt:POWer:ALL? | | 6.106 |
| :FETCh:BURSt:POWer[:IMMediate]? | | 6.105 |
| :FETCh:PTEMplate:REFerence? | TXBand | 6.111 |
| :FETCh:SPECTrum:MODulation[:ALL]? | ARFCn TXBand RXBand COMBined DCSRx1800 | 6.112 |
| :FETCh:SPECTrum:MODulation:REFerence? | TXBand | 6.113 |
| :FETCh:SPECTrum:SWITChing[:ALL]? | | 6.114 |
| :FETCh:SPECTrum:SWITChing:REFerence? | TXBand | 6.114 |
| :FETCh:SPURious:STEP? | | 6.116 |
| :FETCh:SPURious[:ALL]? | TXBand OTXBand RXBand IDLeband | 6.115 |
| :FORMat[:DATA] | ASCIi REAL UINT [,32] | 6.117 |
| :FORMat:DEXPort:APPend[:STATe] | ON OFF | 6.118 |
| :FORMat:DEXPort:COMMeNt | <string> | 6.118 |
| :FORMat:DEXPort:DSEParator | POINT COMMa | 6.118 |
| :FORMat:DEXPort:HEADer[:STATe] | ON OFF | 6.118 |
| :HCOPy:ABORt | | 6.120 |
| :HCOPy:DEStination<1 2> | 'SYST:COMM:GPIB' 'SYST:COMM:SER1' 'SYST:COMM:SER2' 'SYST:COMM:CENt' 'MMEM' | 6.120 |
| :HCOPy:DEStination<1 2>? | 'MMEM' 'SYST:COMM:PRIN' 'SYST:COMM:CLIP' | 6.120 |
| :HCOPy:DEVice:COLor | ON OFF | 6.121 |
| :HCOPy:DEVice:LANGUage<1 2> | WMF EWMF GDI BMP | 6.121 |

| Command | Parameter | Page |
|---|--|-------|
| :HCOPY:DEvice:LANGUage<1 2> | HPGL PCL4 PCL5 POSTscript ESCP WMF PCX HP7470... | 6.121 |
| :HCOPY:DEvice:PRESet<1 2> | ON OFF | 6.122 |
| :HCOPY:DEvice:RESolution<1 2> | 150 300 | 6.122 |
| :HCOPY:ITEM:ALL | | 6.122 |
| :HCOPY:ITEM:FFeEd<1 2>:STATe | ON OFF | 6.123 |
| :HCOPY:ITEM:LABel:TEXT | <string> | 6.123 |
| :HCOPY:ITEM:PFEEd<1 2>:STATe | ON OFF | 6.123 |
| :HCOPY:ITEM:WINDow<1 2>:TABLe:STATe | ON OFF | 6.123 |
| :HCOPY:ITEM:WINDow<1 2>:TEXT | <string> | 6.123 |
| :HCOPY:ITEM:WINDow<1 2>:TRACe:CAINcrement | ON OFF | 6.124 |
| :HCOPY:ITEM:WINDow<1 2>:TRACe:STATe | ON OFF | 6.124 |
| :HCOPY:PAGE:DIMensions:FULL | | 6.124 |
| :HCOPY:PAGE:DIMensions:QUADrant<1 to 4> | | 6.124 |
| :HCOPY:PAGE:ORientation<1 2> | LANDscape PORTrait | 6.124 |
| :HCOPY[:IMMediate] | | 6.122 |
| :INITiate<1 2>:CONMeas | | 6.125 |
| :INITiate<1 2>:CONTinuous | ON OFF | 6.125 |
| :INITiate<1 2>:DISPlay | ON OFF | 6.126 |
| :INITiate<1 2>[:IMMediate] | | 6.125 |
| :INPut<1 2>:ATTenuation | 0 to 70dB | 6.127 |
| :INPut<1 2>:ATTenuation:AUTO | ON OFF | 6.127 |
| :INPut<1 2>:ATTenuation:AUTO:MODE | NORMal LNOise LDISTorsion | 6.127 |
| :INPut<1 2>:ATTenuation:STEPsize | 1dB 10dB | 6.128 |
| :INPut<1 2>:IMPedance | 50 75 | 6.128 |
| :INPut<1 2>:IMPedance:CORRection | RAM RAZ | 6.129 |
| :INPut<1 2>:MIXer | -10 to -100 dBm | 6.129 |
| :INPut<1 2>:UPORt<1 2>:STATe | ON OFF | 6.128 |
| :INPut<1 2>:UPORt<1 2>[:VALue] | | 6.128 |
| :INSTrument:COUPle | NONE MODE X Y CONTrol XY XCONtrol YCONtrol ALL | 6.131 |
| :INSTrument<1 2>:NSElect | 1to 5 | 6.130 |
| :INSTrument<1 2>[:SElect] | SANalyzer DDEMod ADEMod BGSM MGSM | 6.130 |
| :MMEMory:CATalog? | <string> | 6.133 |
| :MMEMory:CDIRectory | directory name | 6.134 |
| :MMEMory:CLear:ALL | | 6.138 |
| :MMEMory:CLear:STATe | 1,path | 6.138 |
| :MMEMory:COMMent | <string> | 6.142 |
| :MMEMory:COPIY | path, file name | 6.134 |
| :MMEMory:DATA | <file name>,<block data> | 6.134 |
| :MMEMory:DELeTe | path, file name | 6.135 |
| :MMEMory:INITialize | 'A:' | 6.135 |
| :MMEMory:LOAD:AUTO | 1,path | 6.136 |
| :MMEMory:LOAD:STATe | path, file name | 6.135 |
| :MMEMory:MDIRectory | path | 6.136 |
| :MMEMory:MOVE | path, file name | 6.136 |

| Command | Parameter | Page |
|--|---|-------|
| :MMEMory:MSIS | 'A:' 'C:' | 6.137 |
| :MMEMory:NAME | path, file name | 6.137 |
| :MMEMory:RDIREctory | directory name | 6.137 |
| :MMEMory:SElect[:ITEM]:ALL | | 6.141 |
| :MMEMory:SElect[:ITEM]:CSEtup | ON OFF | 6.140 |
| :MMEMory:SElect[:ITEM]:CVL[:ACTive] | ON OFF | 6.141 |
| :MMEMory:SElect[:ITEM]:CVL:ALL | ON OFF | 6.141 |
| :MMEMory:SElect[:ITEM]:DEFault | | 6.142 |
| :MMEMory:SElect[:ITEM]:GSEtup | ON OFF | 6.138 |
| :MMEMory:SElect[:ITEM]:HCOPY | ON OFF | 6.140 |
| :MMEMory:SElect[:ITEM]:HWSettings | ON OFF | 6.139 |
| :MMEMory:SElect[:ITEM]:LINES[:ACTive] | ON OFF | 6.139 |
| :MMEMory:SElect[:ITEM]:LINES:ALL | ON OFF | 6.139 |
| :MMEMory:SElect[:ITEM]:MACRos | ON OFF | 6.140 |
| :MMEMory:SElect[:ITEM]:NONE | | 6.142 |
| :MMEMory:SElect[:ITEM]:SCData | ON OFF | 6.140 |
| :MMEMory:SElect[:ITEM]:TRACe<1 to 4> | ON OFF | 6.139 |
| :MMEMory:SElect[:ITEM]:TRANSDucer[:ACTive] | ON OFF | 6.140 |
| :MMEMory:SElect[:ITEM]:TRANSDucer:ALL | ON OFF | 6.141 |
| :MMEMory:STORE:STATE | path, file name | 6.137 |
| :MMEMory:STORE:TRACe | 1 to 4, path | 6.138 |
| :OUTPut:AF:SENSitivity | 0.1 PCT to 100 PCT for AM 0.1 KHZ to 100 KHZ for FM 0.0 1RAD to 10 RAD for PM | 6.144 |
| :OUTPut:UPORt<1 2>:STATE | ON OFF | 6.143 |
| :OUTPut:UPORt<1 2>[:VALue] | #B00000000 to #B11111111 | 6.143 |
| :OUTPut[:STATE] | ON OFF | 6.143 |
| :READ:BURSt:FERRor:AVERAge? | | 6.148 |
| :READ:BURSt:FERRor:MAXimum? | | 6.149 |
| :READ:BURSt:FERRor:STATus? | | 6.148 |
| :READ:BURSt:MACCuracy:FREQuency:AVERAge? | | 6.158 |
| :READ:BURSt:MACCuracy:FREQuency:MAXimum? | | 6.158 |
| :READ:BURSt:MACCuracy:FREQuency:STATus? | | 6.158 |
| :READ:BURSt:MACCuracy:OPSUPpress:AVERAge? | | 6.156 |
| :READ:BURSt:MACCuracy:OPSUPpress:MAXimum? | | 6.156 |
| :READ:BURSt:MACCuracy:OPSUPpress:STATus? | | 6.156 |
| :READ:BURSt:MACCuracy:PEAK:AVERAge? | | 6.155 |
| :READ:BURSt:MACCuracy:PEAK:MAXimum? | | 6.155 |
| :READ:BURSt:MACCuracy:PEAK:STATus? | | 6.155 |
| :READ:BURSt:MACCuracy:PERCentile:AVERAge? | | 6.157 |
| :READ:BURSt:MACCuracy:PERCentile:MAXimum? | | 6.157 |
| :READ:BURSt:MACCuracy:PERCentile:STATus? | | 6.157 |
| :READ:BURSt:MACCuracy:RMS:AVERAge? | | 6.154 |
| :READ:BURSt:MACCuracy:RMS:MAXimum? | | 6.154 |
| :READ:BURSt:MACCuracy:RMS:STATus? | | 6.154 |
| :READ:BURSt:PERRor:PEAK:AVERAge? | | 6.147 |
| :READ:BURSt:PERRor:PEAK:MAXimum? | | 6.148 |

| Command | Parameter | Page |
|--|---|-------|
| :READ:BURSt:PERRor:PEAK:STATus? | | 6.147 |
| :READ:BURSt:PERRor:RMS:AVERAge? | | 6.146 |
| :READ:BURSt:PERRor:RMS:MAXimum? | | 6.147 |
| :READ:BURSt:PERRor:RMS:STATus? | | 6.146 |
| :READ:BURSt:POWer:DYNamic? | | 6.152 |
| :READ:BURSt:POWer:POWer:LEVel? | | 6.153 |
| :READ:BURSt:POWer:STATic? | | 6.151 |
| :READ:BURSt:POWer? | | 6.149 |
| :READ:BURSt:REFerence[:IMMediate]? | | 6.153 |
| :READ:SPECTrum:MODulation[:ALL]? | | 6.159 |
| :READ:SPECTrum:SWITChing[:ALL]? | | 6.160 |
| :READ:SPURious[:ALL]? | | 6.161 |
| :READ:SPURious:STEP? | | 6.162 |
| :[SENSe<1 2>:]ADEMod:AF:COUPling | AC DC | 6.163 |
| :[SENSe<1 2>:]ADEMod:RTIME | ON OFF | 6.164 |
| :[SENSe<1 2>:]ADEMod:SBANd | NORMal INVerse | 6.164 |
| :[SENSe<1 2>:]ADEMod:SQUelch:LEVel | 30 to -150 dBm | 6.164 |
| :[SENSe<1 2>:]ADEMod:SQUelch[:STATe] | ON OFF | 6.163 |
| :[SENSe<1 2>:]AVERAge:AUTO | ON OFF | 6.165 |
| :[SENSe<1 2>:]AVERAge:COUnT | 0 to 256 | 6.165 |
| :[SENSe<1 2>:]AVERAge[:STATe] | ON OFF | 6.165 |
| :[SENSe<1 2>:]AVERAge:TYPE | MAXimum SCALar | 6.166 |
| :[SENSe<1 2>:]BANDwidth BWIDth:DEMod | 5 kHz to 200 kHz (Real Time on) 5 kHz to 5 MHz (Real Time off) | 6.169 |
| :[SENSe<1 2>:]BANDwidth BWIDth:PLL | AUTO HIGH MEDIUM LOW | 6.170 |
| :[SENSe<1 2>:]BANDwidth BWIDth[:RESolution] | 10Hz to 10MHz (model 20), 1Hz to 10MHz (model 30) | 6.167 |
| :[SENSe<1 2>:]BANDwidth BWIDth[:RESolution]:AUTO | ON OFF | 6.168 |
| :[SENSe<1 2>:]BANDwidth BWIDth[:RESolution]:MODE | ANALog DIGital | 6.168 |
| :[SENSe<1 2>:]BANDwidth BWIDth[:RESolution]:MODE:FFT | ON OFF | 6.168 |
| :[SENSe<1 2>:]BANDwidth BWIDth[:RESolution]:RATio | 0.0001 to 1 | 6.168 |
| :[SENSe<1 2>:]BANDwidth BWIDth:VIDeo | 1Hz to 10MHz | 6.169 |
| :[SENSe<1 2>:]BANDwidth BWIDth:VIDeo:AUTO | ON OFF | 6.169 |
| :[SENSe<1 2>:]BANDwidth BWIDth:VIDeo:RATio | 0.001 to 1000 SINE PULSE NOISE | 6.169 |
| :[SENSe<1 2>:]CORRection:COLlect[:ACQuire] | THROUGH OPEN | 6.172 |
| :[SENSe<1 2>:]CORRection:CVL:Band | A Q U V E W F D G Y J | 6.179 |
| :[SENSe<1 2>:]CORRection:CVL:BIAS | <numeric_value> | 6.180 |
| :[SENSe<1 2>:]CORRection:CVL:CATalog? | | 6.178 |
| :[SENSe<1 2>:]CORRection:CVL:CLEar | | 6.180 |
| :[SENSe<1 2>:]CORRection:CVL:COMMent | <string> | 6.180 |
| :[SENSe<1 2>:]CORRection:CVL:DATA | <freq>,<level>.. | 6.180 |
| :[SENSe<1 2>:]CORRection:CVL:MIXer | <string> | 6.178 |
| :[SENSe<1 2>:]CORRection:CVL:PORTs | 2 3 | 6.179 |
| :[SENSe<1 2>:]CORRection:CVL:SElect | <file_name> | 6.178 |
| :[SENSe<1 2>:]CORRection:CVL:SNUMber | <string> | 6.179 |
| :[SENSe<1 2>:]CORRection:CVL:TYPE | ODD EVEN EODD | 6.179 |

| Command | Parameter | Page |
|---|---|-------|
| :[SENSe<1 2>:]CORRection:LOSS:INPut[:MAGNitude] | <value of ext. attenuation in dB> | 6.177 |
| :[SENSe<1 2>:]CORRection:METHod | TRANsmission REFLeXion | 6.172 |
| :[SENSe<1 2>:]CORRection:RECall | | 6.172 |
| :[SENSe<1 2>:]CORRection:RXGain:INPut[:MAGNitude] | <value of the amplification in dB> | 6.177 |
| :[SENSe<1 2>:]CORRection:TRANsducer:ACTive? | | 6.173 |
| :[SENSe<1 2>:]CORRection:TRANsducer:CATalog? | | 6.173 |
| :[SENSe<1 2>:]CORRection:TRANsducer:COMMeNt | <string> | 6.174 |
| :[SENSe<1 2>:]CORRection:TRANsducer:DATA | <freq>,<level>.. | 6.174 |
| :[SENSe<1 2>:]CORRection:TRANsducer:DELeTe | | 6.175 |
| :[SENSe<1 2>:]CORRection:TRANsducer:SCALing | LINear LOGarithmic | 6.174 |
| :[SENSe<1 2>:]CORRection:TRANsducer:SELeCt | <name> | 6.173 |
| :[SENSe<1 2>:]CORRection:TRANsducer[:STATe] | ON OFF | 6.174 |
| :[SENSe<1 2>:]CORRection:TRANsducer:UNIT | <string> | 6.173 |
| :[SENSe<1 2>:]CORRection:TSET:ACTive? | | 6.175 |
| :[SENSe<1 2>:]CORRection:TSET:BReAk | ON OFF | 6.176 |
| :[SENSe<1 2>:]CORRection:TSET:CATalog? | | 6.175 |
| :[SENSe<1 2>:]CORRection:TSET:COMMeNt | <string> | 6.176 |
| :[SENSe<1 2>:]CORRection:TSET:DELeTe | | 6.177 |
| :[SENSe<1 2>:]CORRection:TSET:RANGe<1 to 10> | <freq>,<freq>,<name>.. | 6.176 |
| :[SENSe<1 2>:]CORRection:TSET:SELeCt | <name> | 6.175 |
| :[SENSe<1 2>:]CORRection:TSET[:STATe] | ON OFF | 6.177 |
| :[SENSe<1 2>:]CORRection:TSET:UNIT | <string> | 6.176 |
| :[SENSe<1 2>:]CORRection[:STATe] | ON OFF | 6.172 |
| :[SENSe<1 2>:]DDEMod:FiLTeR:ALPHa | 0.2 to 1 | 6.185 |
| :[SENSe<1 2>:]DDEMod:FiLTeR:MEASurement | OFF RCOSine RRCosine GAUSSian B22 B25 B44 QFM FM95 QFR FR95 QRM RM95 QRR RR95 A25Fm EMES EREF | 6.185 |
| :[SENSe<1 2>:]DDEMod:FiLTeR:REFerence | RCOSine RRCosine GAUSSian B22 B25 B44 QFM FM95 QFR FR95 QRM RM95 QRR RR95 A25Fm EMES EREF | 6.185 |
| :[SENSe<1 2>:]DDEMod:FORMat | QPSK PSK MSK QAM FSK | 6.183 |
| :[SENSe<1 2>:]DDEMod:FSK:NSTate | 2 4 | 6.184 |
| :[SENSe<1 2>:]DDEMod:MSK:FORMat | TYPE1 TYPE2 NORMal DIFFerential | 6.184 |
| :[SENSe<1 2>:]DDEMod:NORMalize | ON OFF | 6.186 |
| :[SENSe<1 2>:]DDEMod:PRATe | 1 2 4 8 16 | 6.185 |
| :[SENSe<1 2>:]DDEMod:PRESet | GSM EDGE NADC TETRa DCS1800 PCS1900 PHS PDCup PDCDown APCO25CQPSK APCO25C4FM CDPD DECT CT2 ERMes MODacom PWT TFTS F16 F322 F324 F64 FQCDma F95Cdma RQCDma R95Cdma FNADc RNADc | 6.189 |
| :[SENSe<1 2>:]DDEMod:PSK:FORMat | NORMal DIFFerential N3Pi8 | 6.183 |
| :[SENSe<1 2>:]DDEMod:PSK:NSTate | 2 8 | 6.183 |
| :[SENSe<1 2>:]DDEMod:QAM:NSTate | 16 | 6.184 |

| Command | Parameter | Page |
|---|--|-------|
| :[SENSe<1 2>:]DDEMod:QPSK:FORMat | NORMal DIFFerential OFFSet DPI4 | 6.183 |
| :[SENSe<1 2>:]DDEMod:SBANd | NORMal INVerse | 6.183 |
| :[SENSe<1 2>:]DDEMod:SEARCh:PULSe:STATe | ON OFF | 6.186 |
| :[SENSe<1 2>:]DDEMod:SEARCh:SYNC:CATalog? | | 6.186 |
| :[SENSe<1 2>:]DDEMod:SEARCh:SYNC:COMMeNt | <string> | 6.187 |
| :[SENSe<1 2>:]DDEMod:SEARCh:SYNC:DATA | <string> | 6.187 |
| :[SENSe<1 2>:]DDEMod:SEARCh:SYNC:DELeTe | <string> | 6.188 |
| :[SENSe<1 2>:]DDEMod:SEARCh:SYNC:MONLy | ON OFF | 6.188 |
| :[SENSe<1 2>:]DDEMod:SEARCh:SYNC:NAME | <string> | 6.187 |
| :[SENSe<1 2>:]DDEMod:SEARCh:SYNC:OFFSet | <numeric_value> | 6.186 |
| :[SENSe<1 2>:]DDEMod:SEARCh:SYNC:PATTeRn | <string> | 6.187 |
| :[SENSe<1 2>:]DDEMod:SEARCh:SYNC:SELeCt | <string> | 6.186 |
| :[SENSe<1 2>:]DDEMod:SEARCh:SYNC:STATe | ON OFF | 6.187 |
| :[SENSe<1 2>:]DDEMod:SEARCh:TIME | 100 to 1600 | 6.188 |
| :[SENSe<1 2>:]DDEMod:SRATe | 160 Hz to 1.6 MHz | 6.184 |
| :[SENSe<1 2>:]DDEMod:TIME | 1 to Frame Length | 6.184 |
| :[SENSe<1 2>:]DETeCtor<1 to 4>:[FUNcTIon] | APeak NEgative POSitive SAMPlE RMS AVERAge | 6.181 |
| :[SENSe<1 2>:]DETeCtor<1 to 4>:[FUNcTIon]:AUTO | ON OFF | 6.181 |
| :[SENSe<1 2>:]FILTeR:CCITf[:STATe] | ON OFF | 6.191 |
| :[SENSe<1 2>:]FILTeR:CMESsage[:STATe] | ON OFF | 6.191 |
| :[SENSe<1 2>:]FILTeR:DEMPHasiS:LiNK | DISPlay AUDio | 6.192 |
| :[SENSe<1 2>:]FILTeR:DEMPHasiS:TCONStant | <numeric_value> | 6.192 |
| :[SENSe<1 2>:]FILTeR:DEMPHasiS[:STATe] | ON OFF | 6.191 |
| :[SENSe<1 2>:]FILTeR:HPASs:FREQuency | 30 Hz 300 Hz | 6.190 |
| :[SENSe<1 2>:]FILTeR:HPASS[:STATe] | ON OFF | 6.190 |
| :[SENSe<1 2>:]FILTeR:LPASs:FREQuency | 3 kHz 15 kHz (real time on) 5 PCT 10 PCT 25 PCT (real time off) | 6.191 |
| :[SENSe<1 2>:]FILTeR:LPASs[:STATe] | ON OFF | 6.190 |
| :[SENSe<1 2>:]FREQuency:CENTer | 0 GHz to f_{max} | 6.193 |
| :[SENSe<1 2>:]FREQuency:CENTer:LiNK | STARt STOP SPAN | 6.193 |
| :[SENSe<1 2>:]FREQuency:CENTer:STEP | 0 to f_{max} | 6.193 |
| :[SENSe<1 2>:]FREQuency:CENTer:STEP:LiNK | SPAN RBW OFF | 6.194 |
| :[SENSe<1 2>:]FREQuency:CENTer:STEP:LiNK:FAcTOr | 1 to 100 PCT | 6.194 |
| :[SENSe<1 2>:]FREQuency:MODE | CW FiXed SWEep | 6.196 |
| :[SENSe<1 2>:]FREQuency:OFFSet | <numeric_value> | 6.196 |
| :[SENSe<1 2>:]FREQuency:SPAN | 0 GHz to f_{max} | 6.194 |
| :[SENSe<1 2>:]FREQuency:SPAN:FULL | | 6.194 |
| :[SENSe<1 2>:]FREQuency:SPAN:LiNK | CENTer STOP SPAN | 6.194 |
| :[SENSe<1 2>:]FREQuency:STARt | 0 GHz to f_{max} | 6.195 |
| :[SENSe<1 2>:]FREQuency:STARt:LiNK | CENTer STOP SPAN | 6.195 |
| :[SENSe<1 2>:]FREQuency:STOP | 0 GHz to f_{max} | 6.195 |
| :[SENSe<1 2>:]FREQuency:STOP:LiNK | CENTer STARt SPAN | 6.195 |
| :[SENSe<1 2>:]MiXer:BIAS | <numeric_value> | 6.200 |
| :[SENSe<1 2>:]MiXer:BLOCK | ON OFF | 6.197 |
| :[SENSe<1 2>:]MiXer:HARMonic | 1 to 62 | 6.198 |

| Command | Parameter | Page |
|--|--|-------|
| :[SENSe<1 2>:]MIXer:HARMonic:BAND | A Q U V E W F D G Y J | 6.199 |
| :[SENSe<1 2>:]MIXer:HARMonic:TYPE | ODD EVEN EODD | 6.199 |
| :[SENSe<1 2>:]MIXer:LOSS:HIGH | <numeric_value> | 6.199 |
| :[SENSe<1 2>:]MIXer:LOSS:TABLE | <file_name> | 6.200 |
| :[SENSe<1 2>:]MIXer:LOSS[:LOW] | <numeric_value> | 6.199 |
| :[SENSe<1 2>:]MIXer:PORTs | 2 3 | 6.198 |
| :[SENSe<1 2>:]MIXer:SIGNAL | ON OFF AUTO | 6.198 |
| :[SENSe<1 2>:]MIXer:THReshold | 0.1 to 100 dB | 6.198 |
| :[SENSe<1 2>:]MIXer[:STATe] | ON OFF | 6.197 |
| :[SENSe<1 2>:]MSUMmary:AHOLd[:STATe] | ON OFF | 6.201 |
| :[SENSe<1 2>:]MSUMmary:MODE | ABSolute RELative | 6.201 |
| :[SENSe<1 2>:]MSUMmary:MTIME | 0.1 s 1 s | 6.202 |
| :[SENSe<1 2>:]MSUMmary:REFerence | <numeric_value> | 6.202 |
| :[SENSe<1 2>:]MSUMmary:REFerence:AUTO | ONCE | 6.202 |
| :[SENSe<1 2>:]MSUMmary:RUNit | PCT DB | 6.201 |
| :[SENSe<1 2>:]POWer:ACHannel:ACPairs | 1 to 3 | 6.204 |
| :[SENSe<1 2>:]POWer:ACHannel:BANDwidth BWIDth:ACHannel | 0 to 1000MHz | 6.204 |
| :[SENSe<1 2>:]POWer:ACHannel:BANDwidth BWIDth:ALTErnate<1 2> | 0 to 1000MHz | 6.204 |
| :[SENSe<1 2>:]POWer:ACHannel:BANDwidth BWIDth[:CHANnel] | 0 to 1000 MHz | 6.204 |
| :[SENSe<1 2>:]POWer:ACHannel:MODE | ABSolute RELative | 6.205 |
| :[SENSe<1 2>:]POWer:ACHannel:PRESet | ACPower CPOWER OBANDwidth OBWidth CN CN0 ADJust | 6.205 |
| :[SENSe<1 2>:]POWer:ACHannel:REFerence:AUTO | ONCE | 6.205 |
| :[SENSe<1 2>:]POWer:ACHannel:SPACing:ACHannel | 0 to 1000MHz | 6.203 |
| :[SENSe<1 2>:]POWer:ACHannel:SPACing:ALTErnate<1 2> | 0 to 1000MHz | 6.203 |
| :[SENSe<1 2>:]POWer:ACHannel:SPACing[:UPPer] | 0 to 1000 MHz | 6.203 |
| :[SENSe<1 2>:]POWer:BANDwidth BWIDth | 0 to 100PCT | 6.205 |
| :[SENSe<1 2>:]ROSCillator:EXTernal:FREQuency | 1MHz to 16MHz | 6.206 |
| :[SENSe<1 2>:]ROSCillator[:INTernal]:TUNE | 0 to 4095 | 6.206 |
| :[SENSe<1 2>:]ROSCillator[:INTernal]:TUNE:SAVE | | 6.206 |
| :[SENSe<1 2>:]ROSCillator:SOURce | INTernal EXTernal | 6.206 |
| :[SENSe<1 2>:]SWEep:COUNT | 0 to 32767 | 6.208 |
| :[SENSe<1 2>:]SWEep:EGATE | ON OFF | 6.208 |
| :[SENSe<1 2>:]SWEep:EGATE:HOLDoff | 0 to 100s | 6.209 |
| :[SENSe<1 2>:]SWEep:EGATE:LENGth | 0 to 100s | 6.209 |
| :[SENSe<1 2>:]SWEep:EGATE:LEVel | -5V to +5V | 6.208 |
| :[SENSe<1 2>:]SWEep:EGATE:POLarity | POSitive NEGative | 6.208 |
| :[SENSe<1 2>:]SWEep:EGATE:SOURce | EXTernal RFPower | 6.209 |
| :[SENSe<1 2>:]SWEep:EGATE:TYPE | LEVel EDGE | 6.208 |
| :[SENSe<1 2>:]SWEep:GAP | ON OFF | 6.209 |
| :[SENSe<1 2>:]SWEep:GAP:LENGth | 0 to 100s | 6.210 |
| :[SENSe<1 2>:]SWEep:GAP:PRETrigger | 0 to 100s | 6.209 |
| :[SENSe<1 2>:]SWEep:GAP:TRGTogap | 0 to 100s | 6.210 |
| :[SENSe<1 2>:]SWEep:POINTS | 500 to 2000 | 6.210 |
| :[SENSe<1 2>:]SWEep:TIME | <numeric_value> | 6.207 |
| :[SENSe<1 2>:]SWEep:TIME:AUTO | ON OFF | 6.207 |
| :[SENSe<1 2>:]JTCAPture:LENGth | 1024 2048 4096 8192 16384 | 6.189 |

| Command | Parameter | Page |
|---|---|-------------|
| :[SENSe<1 2>:]TV:PSOFFset | 0 to 6.5 MHz | 6.211 |
| :[SENSe<1 2>:]TV[:STATe] | ON OFF | 6.211 |
| :SOURce:AM:STATe | ON OFF | 6.212 |
| :SOURce:DM:STATe | ON OFF | 6.212 |
| :SOURce:FREQuency:OFFSet | -200 MHz to 200 MHz | 6.213 |
| :SOURce:POWer:ALC:SOURce | INTernal EXTernal | 6.213 |
| :SOURce:POWer[:LEVel][:IMMEDIATE]:OFFSet | -200 dB to +200 dB | 6.213 |
| :SOURce:POWer[:LEVel][:IMMEDIATE][:AMPLitude] | 20dBm to 0dBm / Option FSE-B12: -90 to 0 dBm | 6.213 |
| :STATus:OPERation:CONDition? | | 6.215 |
| :STATus:OPERation:ENABLE | 0 to 65535 | 6.216 |
| :STATus:OPERation[:EVENT]? | | 6.215 |
| :STATus:OPERation:NTRansition | 0 to 65535 | 6.216 |
| :STATus:OPERation:PTRansition | 0 to 65535 | 6.216 |
| :STATus:QUEStionable:CONDition? | | 6.217 |
| :STATus:QUEStionable:ENABLE | 0 to 65535 | 6.217 |
| :STATus:QUEStionable[:EVENT]? | | 6.217 |
| :STATus:QUEStionable:NTRansition | 0 to 65535 | 6.217 |
| :STATus:QUEStionable:PTRansition | 0 to 65535 | 6.217 |
| :STATus:PRESet | | 6.216 |
| :STATus:QUEStionable:ACPLimit:CONDition? | | 6.222 |
| :STATus:QUEStionable:ACPLimit:ENABLE | 0 to 65535 | 6.222 |
| :STATus:QUEStionable:ACPLimit[:EVENT]? | | 6.222 |
| :STATus:QUEStionable:ACPLimit:NTRansition | 0 to 65535 | 6.222 |
| :STATus:QUEStionable:ACPLimit:PTRansition | 0 to 65535 | 6.222 |
| :STATus:QUEStionable:FREQuency:CONDition? | | 6.223 |
| :STATus:QUEStionable:FREQuency:ENABLE | 0 to 65535 | 6.223 |
| :STATus:QUEStionable:FREQuency[:EVENT]? | | 6.223 |
| :STATus:QUEStionable:FREQuency:NTRansition | 0 to 65535 | 6.224 |
| :STATus:QUEStionable:FREQuency:PTRansition | 0 to 65535 | 6.223 |
| :STATus:QUEStionable:LIMit:CONDition? | | 6.219 |
| :STATus:QUEStionable:LIMit:ENABLE | 0 to 65535 | 6.219 |
| :STATus:QUEStionable:LIMit[:EVENT]? | | 6.219 |
| :STATus:QUEStionable:LIMit:NTRansition | 0 to 65535 | 6.219 |
| :STATus:QUEStionable:LIMit:PTRansition | 0 to 65535 | 6.219 |
| :STATus:QUEStionable:LMARgin:CONDition? | | 6.220 |
| :STATus:QUEStionable:LMARgin:ENABLE | 0 to 65535 | 6.220 |
| :STATus:QUEStionable:LMARgin[:EVENT]? | | 6.220 |
| :STATus:QUEStionable:LMARgin:NTRansition | 0 to 65535 | 6.220 |
| :STATus:QUEStionable:LMARgin:PTRansition | 0 to 65535 | 6.220 |
| :STATus:QUEStionable:POWer:CONDition? | | 6.218 |
| :STATus:QUEStionable:POWer:ENABLE | 0 to 65535 | 6.218 |
| :STATus:QUEStionable:POWer[:EVENT]? | | 6.218 |
| :STATus:QUEStionable:POWer:NTRansition | 0 to 65535 | 6.218 |
| :STATus:QUEStionable:POWer:PTRansition | 0 to 65535 | 6.218 |
| :STATus:QUEStionable:SYNC:CONDition? | | 6.221 |
| :STATus:QUEStionable:SYNC:ENABLE | 0 to 65535 | 6.221 |

| Command | Parameter | Page |
|---|---|-------|
| :STATus:QUEStionable:SYNC[:EVENT]? | | 6.221 |
| :STATus:QUEStionable:SYNC:NTRansition | 0 to 65535 | 6.221 |
| :STATus:QUEStionable:SYNC:PTRansition | 0 to 65535 | 6.221 |
| :STATus:QUEStionable:TRANSDucer:CONDition? | | 6.224 |
| :STATus:QUEStionable:TRANSDucer:ENABLE | 0 to 65535 | 6.224 |
| :STATus:QUEStionable:TRANSDucer[:EVENT]? | | 6.224 |
| :STATus:QUEStionable:TRANSDucer:NTRansition | 0 to 65535 | 6.225 |
| :STATus:QUEStionable:TRANSDucer:PTRansition | 0 to 65535 | 6.225 |
| :STATus:QUEue[:NEXT]? | | 6.225 |
| :SYSTem:BINFo? | | 6.232 |
| :SYSTem:COMMunicate:GPIB:RDEvice<1 2>:ADDRess | 0 to 30 | 6.227 |
| :SYSTem:COMMunicate:GPIB[:SELF]:ADDRess | 0 to 30 | 6.226 |
| :SYSTem:COMMunicate:GPIB[:SELF]:RTERminator | LFEOI EOI | 6.227 |
| :SYSTem:COMMunicate:PRINter<1 2>:ENUMerate:FIRSt? | | 6.229 |
| :SYSTem:COMMunicate:PRINter<1 2>:ENUMerate:NEXt? | | 6.229 |
| :SYSTem:COMMunicate:PRINter<1 2>:SELect | <printer_name> | 6.229 |
| :SYSTem:COMMunicate:SERial<1 2>:CONTRol:DTR | IBFull OFF | 6.227 |
| :SYSTem:COMMunicate:SERial<1 2>:CONTRol:RTS | IBFull OFF | 6.227 |
| :SYSTem:COMMunicate:SERial<1 2>[:RECeive]:BAUD | <numeric_value> | 6.227 |
| :SYSTem:COMMunicate:SERial<1 2>[:RECeive]:BITS | 7 8 | 6.228 |
| :SYSTem:COMMunicate:SERial<1 2>[:RECeive]:PACE | XON NONE | 6.228 |
| :SYSTem:COMMunicate:SERial<1 2>[:RECeive]:PARity[:TYPE] | EVEN ODD NONE | 6.228 |
| :SYSTem:COMMunicate:SERial<1 2>[:RECeive]:SBITs | 1 2 | 6.228 |
| :SYSTem:DATE | 1980 to 2099, 1 to 12, 1 to 31 | 6.229 |
| :SYSTem:DISPlay:UPDate | ON OFF | 6.230 |
| :SYSTem:ERRor? | | 6.230 |
| :SYSTem:FIRMWare:UPDate | 'string' | 6.230 |
| :SYSTem:PASSword[:CENable] | 'password' | 6.230 |
| :SYSTem:PRESet | | 6.231 |
| :SYSTem:SET | <block> | 6.231 |
| :SYSTem:SPEaker<1 2>:VOLume | 0 to 1 | 6.231 |
| :SYSTem:TIME | 0 to 23, 0 to 59, 0 to 59 | 6.231 |
| :SYSTem:VERSIon? | | 6.232 |
| :TRACe:COpy | TRACE1 TRACE2 TRACE3 TRACE4, TRACE1 TRACE2 TRACE3 TRACE4 | 6.234 |
| :TRACe[:DATA] | TRACE1 TRACE2 TRACE3 TRACE4, <block> <numeric_value> | 6.233 |
| :TRIGger<1 2>[:SEQuence]:HOLDoff | -100s to 100 s | 6.236 |
| :TRIGger<1 2>[:SEQuence]:LEVel:AF | AM-Demod -120 to +120 PCT, FM-Demod -1kHz to +1 kHz, PM-Demod -12 .to.. +12 RAD | 6.236 |
| :TRIGger<1 2>[:SEQuence]:LEVel:VIDeo | 0 to 100 PCT | 6.236 |
| :TRIGger<1 2>[:SEQuence]:LEVel[:EXTernal] | -5.0 V to +5.0 V | 6.236 |
| :TRIGger<1 2>[:SEQuence]:SLOPe | POSitive NEGative | 6.237 |
| :TRIGger<1 2>[:SEQuence]:SOURce | IMMediate LINE EXTernal VIDeo RFPower TV AF | 6.235 |
| :TRIGger<1 2>[:SEQuence]:SYNChronize:ADJust:FRAMe:AUTO | ONCE | 6.238 |

| Command | Parameter | Page |
|--|--|-------|
| :TRIGger<1 2>[:SEQuence]:SYNChronize:ADJJust:SLOT | -100 □ s to 100 s | 6.239 |
| :TRIGger<1 2>[:SEQuence]:SYNChronize:ADJJust:SLOT:AUTO | ONCE | 6.239 |
| :TRIGger<1 2>[:SEQuence]:SYNChronize:SOURce | FRAMe TSC | 6.239 |
| :TRIGger<1 2>[:SEQuence]:VIDeo::FORMat:LPFRame | 525 625 | 6.237 |
| :TRIGger<1 2>[:SEQuence]:VIDeo:FIELD:SElect | ALL ODD EVEN | 6.237 |
| :TRIGger<1 2>[:SEQuence]:VIDeo:LINE:NUMBer | <numeric value> | 6.237 |
| :TRIGger<1 2>[:SEQuence]:VIDeo:SSIGnal:POLarity | NEGative POSitive | 6.238 |
| :UNIT<1 2>:POWer | DBM DBPW WATT DBUV DBMV VOLT DBUA AMP DB PCT UNITLESS DBUV_MHZ DBMV_MHZ DBUA_MHZ DBUV_M DBIA_M DBUV_MMHZ DBUA_MMHZ | 6.240 |
| :UNIT<1 2>:PROBe | ON OFF | 6.240 |

Table of Softkeys with IEC/IEEE-Bus Command Assignment

Basic Instrument - Signal Analysis Mode

FREQUENCY Key Group

START

START
MANUAL

: [SENSe<1|2>:]FREQuency:START <num_value>

CENTER
FIXED

: [SENSe<1|2>:]FREQuency:START:LINK CENTER

SPAN
FIXED

: [SENSe<1|2>:]FREQuency:START:LINK SPAN

STOP
FIXED

: [SENSe<1|2>:]FREQuency:START:LINK STOP

FREQ AXIS
LIN LOG

: [SENSe<1|2>:]SWEep:SPACing LIN | LOG

STOP

STOP
MANUAL

: [SENSe<1|2>:]FREQuency:STOP <num_value>

START
FIXED

: [SENSe<1|2>:]FREQuency:STOP:LINK START

CENTER
FIXED

: [SENSe<1|2>:]FREQuency:STOP:LINK CENTER

SPAN
FIXED

: [SENSe<1|2>:]FREQuency:STOP:LINK SPAN

SPAN
FIXED

: [SENSe<1|2>:]FREQuency:STOP:LINK SPAN

FREQ AXIS
LIN LOG

: [SENSe<1|2>:]SWEep:SPACing LIN | LOG

CENTER

CENTER
MANUAL

: [SENSe<1|2>:]FREQuency:CENTER <num_value>

START
FIXED

: [SENSe<1|2>:]FREQuency:CENTER:LINK START

SPAN
FIXED

: [SENSe<1|2>:]FREQuency:CENTER:LINK SPAN

STOP
FIXED

: [SENSe<1|2>:]FREQuency:CENTER:LINK STOP

FREQUENCY
OFFSET

: [SENSe<1|2>:]FREQuency:OFFSet <num_value>

FREQ AXIS
LIN LOG

: [SENSe<1|2>:]SWEep:SPACing LIN | LOG

STEP

AUTO
0.1 * SPAN

: [SENSe<1|2>:]FREQuency:CENTer:STEP:LINK SPAN;
: [SENSe<1|2>:]FREQuency:CENTer:STEP:LINK:FACTOR 10PCT

or

AUTO
0.1 * RBW

: [SENSe<1|2>:]FREQuency:CENTer:STEP:LINK RBW;
: [SENSe<1|2>:]FREQuency:CENTer:STEP:LINK:FACTOR 10PCT

AUTO
0.5 * SPAN

: [SENSe<1|2>:]FREQuency:CENTer:STEP:LINK SPAN;
: [SENSe<1|2>:]FREQuency:CENTer:STEP:LINK:FACTOR 50PCT

or

AUTO
0.5 * RBW

: [SENSe<1|2>:]FREQuency:CENTer:STEP:LINK RBW;
: [SENSe<1|2>:]FREQuency:CENTer:STEP:LINK:FACTOR 50PCT

AUTO
X * SPAN

: [SENSe<1|2>:]FREQuency:CENTer:STEP:LINK SPAN;
: [SENSe<1|2>:]FREQuency:CENTer:STEP:LINK:FACTOR <num_value>

or

AUTO
X * RBW

: [SENSe<1|2>:]FREQuency:CENTer:STEP:LINK RBW;
: [SENSe<1|2>:]FREQuency:CENTer:STEP:LINK:FACTOR <num_value>

STEPSIZE
MANUAL

: [SENSe<1|2>:]FREQuency:CENTer:STEP <num_value>

STEPSIZE
= CENTER

no corresponding IEC/IEEE-bus command

SPAN

SPAN
MANUAL

: [SENSe<1|2>:]FREQuency:SPAN <num_value>

START
FIXED

: [SENSe<1|2>:]FREQuency:SPAN:LINK START

CENTER
FIXED

: [SENSe<1|2>:]FREQuency:SPAN:LINK CENTER

STOP
FIXED

: [SENSe<1|2>:]FREQuency:SPAN:LINK STOP

ZERO
SPAN

: [SENSe<1|2>:]FREQuency:SPAN 0HZ or
: [SENSe<1|2>:]FREQuency:MODE CW | FIXEd

FULL
SPAN

: [SENSe<1|2>:]FREQuency:SPAN:FULL

LAST
SPAN

no corresponding IEC/IEEE-bus command

ZOOM

: DISPlay[:WINDow<1|2>]:TRACe<1...4>:X[:SCALe]:ZOOM ON| OFF

MOVE ZOOM
WINDOW

: DISPlay[:WINDow<1|2>]:TRACe<1...4>:X[:SCALe]:ZOOM[:FREQuency]:CENTER
<num_value>

MOVE ZOOM
START

: DISPlay[:WINDow<1|2>]:TRACe<1...4>:X[:SCALe]:ZOOM[:FREQuency]:START
<num_value>

MOVE ZOOM
STOP

: DISPlay[:WINDow<1|2>]:TRACe<1...4>:X[:SCALe]:ZOOM[:FREQuency]:STOP
<num_value>

ZOOM OFF

: DISPlay[:WINDow<1|2>]:TRACe<1...4>:X[:SCALe]:ZOOM OFF

FREQ AXIS
LIN LOG

: [SENSe<1|2>:]SWEep:SPACing LIN | LOG

LEVEL Key Group

| | |
|-----------------------|--|
| REF | |
| REF LEVEL | :DISPlay[:WINDow<1 2>]:TRACe<1...4>:Y[:SCALe]:RLEVEL <num_value> |
| REF LEVEL OFFSET | :DISPlay[:WINDow<1 2>]:TRACe<1...4>:Y[:SCALe]:RLEVEL:OFFSet <num_value> |
| GRID ABS/REL | :DISPlay[:WINDow<1 2>]:TRACe<1...4>:Y[:SCALe]:MODE ABSolute RELative |
| UNIT | -- |
| dBm | :CALCulate<1 2>:UNIT:POWer DBM |
| dBmV | :CALCulate<1 2>:UNIT:POWer DBMV |
| dBμV | :CALCulate<1 2>:UNIT:POWer DBUV |
| dBμA | :CALCulate<1 2>:UNIT:POWer DBUA |
| dBpW | :CALCulate<1 2>:UNIT:POWer DBPW |
| dB*/MHZ | :CALCulate<1 2>:UNIT:POWer DBUV_MHZ :CALCulate<1 2>:UNIT:POWer DBUA_MHZ :CALCulate<1 2>:UNIT:POWer DBMV_MHZ |
| VOLT | :CALCulate<1 2>:UNIT:POWer VOLT |
| AMPERE | :CALCulate<1 2>:UNIT:POWer AMPere |
| WATT | :CALCulate<1 2>:UNIT:POWer WATT |
| PROBE CODE ON / OFF | :UNIT<1 2>:PROBe ON OFF |
| ATTEN STEP 1dB / 10dB | :INPut<1 2>:ATTenuation:STEPsize 1dB 10dB (with option FSE-B13 only) |
| RF ATTEN MANUAL | :INPut<1 2>:ATTenuation <num_value> |
| ATTEN AUTO NORMAL | :INPut<1 2>:ATTenuation:AUTO:MODE NORMAl; :INPut<1 2>:ATTenuation:AUTO ON |
| ATTEN AUTO LOW NOISE | :INPut<1 2>:ATTenuation:AUTO:MODE LNOise; :INPut<1 2>:ATTenuation:AUTO ON |
| ATTEN AUTO LOW DIST | :INPut<1 2>:ATTenuation:AUTO:MODE LDISTortion; :INPut<1 2>:ATTenuation:AUTO ON |
| MIXER LEVEL | :INPut<1 2>:MIXer <num_value> |
| MAX LEVEL AUTO | :DISPlay[:WINDow<1 2>]:TRACe<1...4>:Y[:SCALe]:RVALue:AUTO ON |
| MAX LEVEL MANUAL | :DISPlay[:WINDow<1 2>]:TRACe<1...4>:Y[:SCALe]:RVALue:AUTO OFF; :DISPlay[:WINDow<1 2>]:TRACe<1...4>:Y[:SCALe]:RVALue <num_value> |

| | |
|-----------------|---|
| RANGE | |
| LOG ... | :DISPlay[:WINDow<1 2>]:TRACe<1...4>:Y:SPACing LOGarithmic; :DISPlay[:WINDow<1 2>]:TRACe<1...4>:Y[:SCALe] <num_value> |
| LINEAR/% | :DISPlay[:WINDow<1 2>]:TRACe<1...4>:Y:SPACing PERCent |
| LINEAR/dB | :DISPlay[:WINDow<1 2>]:TRACe<1...4>:Y:SPACing LINear |
| LOG MANUAL | :DISPlay[:WINDow<1 2>]:TRACe<1...4>:Y:SPACing LOGarithmic; :DISPlay[:WINDow<1 2>]:TRACe<1...4>:Y[:SCALe] <num_value> |
| GRID ABS/REL | :DISPlay[:WINDow<1 2>]:TRACe<1...4>:Y[:SCALe]:MODE ABSolute RELative |

INPUT Key

| | |
|--------------------------|---|
| INPUT | |
| RF ATTEN MANUAL | :INPut<1 2>:ATTenuation <num_value> |
| ATTEN AUTO NORMAL | :INPut<1 2>:ATTenuation:AUTO:MODE NORMAl; :INPut<1 2>:ATTenuation:AUTO ON |
| ATTEN AUTO LOW NOISE | :INPut<1 2>:ATTenuation:AUTO:MODE LNOise; :INPut<1 2>:ATTenuation:AUTO ON |
| ATTEN AUTO LOW DIST | :INPut<1 2>:ATTenuation:AUTO:MODE LDISTortion; :INPut<1 2>:ATTenuation:AUTO ON |
| MIXER LEVEL | :INPut<1 2>:MIXer <num_value> |
| ATTEN STEP 1dB / 10dB | :INPut<1 2>:ATTenuation:STEPsize 1dB 10dB (with option FSE-B13 only) |
| INPUT SELECT | -- |
| RF INPUT 50 OHM | :INPut<1 2>:IMPedance 50 |
| RF INPUT 75 OHM/RAM | :INPut<1 2>:IMPedance:CORRection RAM |
| RF INPUT 75OHM/RAZ | :INPut<1 2>:IMPedance:CORRection RAZ |

MARKER Key Group

| | |
|-------------------------|--|
| NORMAL | |
| MARKER 1..4 | :CALCulate<1 2>:MARKer<1...4>[:STATe] ON OFF; :CALCulate<1 2>:MARKer<1...4>:X <num_value>; :CALCulate<1 2>:MARKer<1...4>:Y? |
| SIGNAL COUNT | :CALCulate<1 2>:MARKer<1...4>:COUNT ON OFF; :CALCulate<1 2>:MARKer<1...4>:COUNT:FREQuency? |
| MARKER DEMODO | |
| MKR DEMOD ON/OFF | :CALCulate<1 2>:MARKer<1...4>:FUNctIon:DEMOdulation[:STATe] ON OFF |
| AM | :CALCulate<1 2>:MARKer<1...4>:FUNctIon:DEMOdulation:SELEct AM |
| FM | :CALCulate<1 2>:MARKer<1...4>:FUNctIon:DEMOdulation:SELEct FM |
| MKR STOP TIME | :CALCulate<1 2>:MARKer<1...4>:FUNctIon:DEMOdulation:HOLDOff <num_value> |
| VOLUME | :SYSTEM:SPEaker<1 2>:VOLume <num_value> |
| MARKER ZOOM | :CALCulate<1 2>:MARKer<1...4>:FUNctIon:ZOOM <num_value> |
| MARKER INFO | DISPlay<1 2>:WINDow<1 2>:MINfo ON OFF (screen display) |
| ALL MARKER OFF | :CALCulate<1 2>:MARKer<1...4>:AOFF |
| POWER MEAS SETTINGS | |
| SET NO OF ADJ CHAN'S | :[SENSe<1 2>:]POWer:ACHannel:ACPairs <num_value> |
| ACP STANDARD | :CALCulate<1 2>:MARKer<1...4>:FUNctIon:POWer:PRESet NADC TETRA PDC PHS CDPD F8CDma R8Cdma F19Cdma R19Cdma NONE FO8Cdma RO8Cdma FO19CDMA RO19CDMA TCDMA |
| CH FILTER ON/OFF | :CALCulate<1 2>:MARKer<1...4>:FUNctIon:POWer:CFILter ON OFF |
| CHANNEL BANDWIDTH | : [SENSe<1 2>:]POWer:ACHannel:BANDwidth BWIDth[:CHANnel] <num_value> : [SENSe<1 2>:]POWer:ACHannel:BANDwidth BWIDth:ACHannel <num_value> : [SENSe<1 2>:]POWer:ACHannel:BANDwidth BWIDth:ALternate<1 2> <num_value> |
| CHANNEL SPACING | : [SENSe<1 2>:]POWer:ACHannel:SPACing[:UPPer] <num_value> : [SENSe<1 2>:]POWer:ACHannel:SPACing:ACHannel <num_value> : [SENSe<1 2>:]POWer:ACHannel:SPACing:ALternate<1 2> <num_value> |
| EDIT ACP LIMITS | :CALCulate<1 2>:LIMit<1...8>:ACPoweR:ACHannel <num_value>,<num_value> :CALCulate<1 2>:LIMit<1...8>:ACPoweR:ACHannel:STATe ON OFF :CALCulate<1 2>:LIMit<1...8>:ACPoweR:ALternate<1 2> <num_value>,<num_value> :CALCulate<1 2>:LIMit<1...8>:ACPoweR:ALternate<1 2>:STATe ON OFF |
| LIMIT CHECK | :CALCulate<1 2>:LIMit:ACPoweR[:STATe] ON OFF :CALCulate<1 2>:LIMit<1...8>:ACPoweR:ACHannel:RESult? :CALCulate<1 2>:LIMit<1...8>:ACPoweR:ALternate<1 2>:RESult? |

| | |
|---------------------|---|
| % POWER BANDWIDTH | :[SENSe<1 2>:]POWer:BAWIDth BWIth <num_value> |
| CHANNEL POWER | :CALCulate<1 2>:MARKer<1...4>:FUNction:POWer:SElect CPower; :CALCulate<1 2>:MARKer<1...4>:FUNction:POWer:RESult? CPower; :CALCulate<1 2>:MARKer<1...4>:FUNction:POWer[:STATE] OFF |
| CP/ACP ABS/REL | :[SENSe<1 2>:]POWer:ACHannel:MODE ABSolute RELative |
| SET CP REFERENCE | :[SENSe<1 2>:]POWer:ACHannel:REFerence:AUTO ONCE |
| C/N | :CALCulate<1 2>:MARKer<1...4>:FUNction:POWer:SElect CN; :CALCulate<1 2>:MARKer<1...4>:FUNction:POWer:RESult? CN; :CALCulate<1 2>:MARKer<1...4>:FUNction:POWer[:STATE] OFF |
| C/No | :CALCulate<1 2>:MARKer<1...4>:FUNction:POWer:SElect CN0; :CALCulate<1 2>:MARKer<1...4>:FUNction:POWer:RESult? CN0; :CALCulate<1 2>:MARKer<1...4>:FUNction:POWer[:STATE] OFF |
| ADJACENT CHAN POWER | :CALCulate<1 2>:MARKer<1...4>:FUNction:POWer:SElect ACPower; :CALCulate<1 2>:MARKer<1...4>:FUNction:POWer:RESult? ACPower; :CALCulate<1 2>:MARKer<1...4>:FUNction:POWer[:STATE] OFF |
| ADJUST CP SETTINGS | :[SENSe<1 2>:]POWer:ACHannel:PRESet ADJust |
| OCCUPIED PWR BANDW | :CALCulate<1 2>:MARKer<1...4>:FUNction:POWer:SElect OBANdwidth Bwidth :CALCulate<1 2>:MARKer<1...4>:FUNction:POWer:RESult? OBANdwidth Bwidth :CALCulate<1 2>:MARKer<1...4>:FUNction:POWer[:STATE] OFF |
| COUNTER RESOL | :CALCulate<1 2>:MARKer<1...4>:COUNT:RESolution <num_value> |
| SIGNAL TRACK | :CALCulate<1 2>:MARKer<1...4>:FUNction:STRack[:STATE] ON OFF |
| NOISE | :CALCulate<1 2>:MARKer<1...4>:FUNction:NOISe[:STATE] ON OFF; :CALCulate<1 2>:MARKer<1...4>:FUNction:NOISe:RESult? |
| STEP | |
| STEP SIZE AUTO | :CALCulate<1 2>:MARKer<1...4>:STEP:AUTO ON OFF |
| STEP SIZE MANUAL | :CALCulate<1 2>:MARKer<1...4>:STEP[:INCRement] <num_value> |
| MKR TO STEP SIZE | :CALCulate<1 2>:MARKer<1...4>:FUNction:MSTep |
| DELTA TO STEP SIZE | -- |

| | |
|-------------------------|--|
| DELTA | |
| DELTA 1...4 | :CALCulate<1 2>:DELTamarker<1...4>[:STATe] ON OFF :CALCulate<1 2>:DELTamarker<1...4>:X <num_value> :CALCulate<1 2>:DELTamarker<1...4>:X:RELative? :CALCulate<1 2>:DELTamarker<1...4>:Y? |
| PHASE NOISE | :CALCulate<1 2>:DELTamarker<1...4>:FUNCTion:PNOise[:STATe] ON OFF :CALCulate<1 2>:DELTamarker<1...4>:FUNCTion:PNOise:RESult? |
| REFERENCE POINT | -- |
| REF POINT LEVEL | :CALCulate<1 2>:DELTamarker<1...4>:FUNCTion:FIXed:RPOint:Y <num_value> |
| REF POINT LVL OFFSET | :CALCulate<1 2>:DELTamarker<1...4>:FUNCTion:FIXed:RPOint:Y:OFFSet <num_value> |
| REF POINT FREQUENCY | :CALCulate<1 2>:DELTamarker<1...4>:FUNCTion:FIXed:RPOint:X <num_value> |
| REF POINT TIME | :CALCulate<1 2>:DELTamarker<1...4>:FUNCTion:FIXed:RPOint:X <num_value> |
| REFERENCE FIXED | :CALCulate<1 2>:DELTamarker<1...4>:FUNCTion:FIXed[:STATe] ON OFF |
| DELTA MKR ABS REL | :CALCulate<1 2>:DELTamarker<1...4>:MODE ABSolute RELative |
| ALL DELTA OFF | :CALCulate<1 2>:DELTamarker<1...4>:AOFF |
| STEP | |
| STEP SIZE AUTO | :CALCulate<1 2>:DELTamarker<1...4>:STEP:AUTO ON OFF |
| MANUAL STEP SIZE | :CALCulate<1 2>:DELTamarker<1...4>:STEP[:INCRement] <num_value> |
| DELTA TO STEP SIZE | -- |
| SEARCH | |
| PEAK | :CALCulate<1 2>:MARKer<1...4>:MAXimum[:PEAK] :CALCulate<1 2>:DELTamarker<1...4>:MAXimum[:PEAK] |
| NEXT PEAK | :CALCulate<1 2>:MARKer<1...4>:MAXimum:NEXT :CALCulate<1 2>:DELTamarker<1...4>:MAXimum:NEXT |
| NEXT PEAK RIGHT | :CALCulate<1 2>:MARKer<1...4>:MAXimum:RIGHT :CALCulate<1 2>:DELTamarker<1...4>:MAXimum:RIGHT |
| NEXT PEAK LEFT | :CALCulate<1 2>:MARKer<1...4>:MAXimum:LEFT :CALCulate<1 2>:DELTamarker<1...4>:MAXimum:LEFT |
| SUM MKR ON/OFF | :CALCulate<1 2>:MARKer<1...4>:FUNCTion:SUMMARY[:STATe] ON OFF |
| SUMMARY MARKER | |

| | |
|-----------------------|---|
| RMS | :CALCulate<1 2>:MARKer<1...4>:FUNCTION:SUMMARY:RMS[:STATE] ON OFF :CALCulate<1 2>:MARKer<1...4>:FUNCTION:SUMMARY:RMS:RESult? :CALCulate<1 2>:MARKer<1...4>:FUNCTION:SUMMARY:RMS:AVERAge:RESult? :CALCulate<1 2>:MARKer<1...4>:FUNCTION:SUMMARY:RMS:PHOLd:RESult? |
| MEAN | :CALCulate<1 2>:MARKer<1...4>:FUNCTION:SUMMARY:MEAN[:STATE] ON OFF :CALCulate<1 2>:MARKer<1...4>:FUNCTION:SUMMARY:MEAN:RESult? :CALCulate<1 2>:MARKer<1...4>:FUNCTION:SUMMARY:MEAN:AVERAge:RESult? :CALCulate<1 2>:MARKer<1...4>:FUNCTION:SUMMARY:MEAN:PHOLd:RESult? |
| PEAK HOLD ON/OFF | :CALCulate<1 2>:MARKer<1...4>:FUNCTION:SUMMARY:PHOLd ON OFF |
| AVERAGE ON/OFF | :CALCulate<1 2>:MARKer<1...4>:FUNCTION:SUMMARY:AVERAge ON OFF |
| SWEEP COUNT | : [SENSe<1 2>:]SWEep:COUNT <num_value> |
| ALL SUM MKR OFF | :CALCulate<1 2>:MARKer<1...4>:FUNCTION:SUMMARY:AOFF |
| SEARCH LIM ON/OFF | :CALCulate<1 2>:MARKer<1...4>:X:SLIMits[:STATE] ON OFF |
| SELECT MARKER | no corresponding IEC/IEEE-bus command |
| ACTIVE MKR/DELTA | no corresponding IEC/IEEE-bus command |
| MIN | :CALCulate<1 2>:MARKer<1...4>:MINimum[:PEAK] :CALCulate<1 2>:DELTAmarker<1...4>:MINimum[:PEAK] |
| NEXT MIN | :CALCulate<1 2>:MARKer<1...4>:MINimum:NEXT :CALCulate<1 2>:DELTAmarker<1...4>:MINimum:NEXT |
| NEXT MIN LEFT | :CALCulate<1 2>:MARKer<1...4>:MINimum:LEFT :CALCulate<1 2>:DELTAmarker<1...4>:MINimum:LEFT |
| NEXT MIN RIGHT | :CALCulate<1 2>:MARKer<1...4>:MINimum:RIGHT :CALCulate<1 2>:DELTAmarker<1...4>:MINimum:RIGHT |
| EXCLUDE LO ON/OFF | :CALCulate<1 2>:MARKer<1...4>:LOEXclude ON OFF |
| PEAK EXCURSION | :CALCulate<1 2>:MARKer<1...4>:PEXCursion <num_value> |
| N dB DOWN | :CALCulate<1 2>:MARKer<1...4>:FUNCTION:NDBDown <num_value> :CALCulate<1 2>:MARKer<1...4>:FUNCTION:NDBDown:STATE ON OFF :CALCulate<1 2>:MARKer<1...4>:FUNCTION:NDBDown:RESult? :CALCulate<1 2>:MARKer<1...4>:FUNCTION:NDBDown:FREQuency? |
| SHAPE FACT 60/3 dB | :CALCulate<1 2>:MARKer<1...4>:FUNCTION:SFACTOR (60dB/3dB) :CALCulate<1 2>:MARKer<1...4>:FUNCTION:SFACTOR:STATE ON OFF :CALCulate<1 2>:MARKer<1...4>:FUNCTION:SFACTOR:RESult? :CALCulate<1 2>:MARKer<1...4>:FUNCTION:SFACTOR:FREQuency? |
| SHAPE FACT 60/6 dB | :CALCulate<1 2>:MARKer<1...4>:FUNCTION:SFACTOR (60dB/6dB) :CALCulate<1 2>:MARKer<1...4>:FUNCTION:SFACTOR:STATE ON OFF :CALCulate<1 2>:MARKer<1...4>:FUNCTION:SFACTOR:RESult? :CALCulate<1 2>:MARKer<1...4>:FUNCTION:SFACTOR:FREQuency? |

| | |
|----------------------|---|
| MKR-> | |
| PEAK | :CALCulate<1 2>:MARKer<1...4>:MAXimum[:PEAK] :CALCulate<1 2>:DELTamarker<1...4>:MAXimum[:PEAK] |
| MKR-> CENTER | :CALCulate<1 2>:MARKer<1...4>:FUNction:CENTer |
| MKR-> REF LEVEL | :CALCulate<1 2>:MARKer<1...4>:FUNction:REFerence |
| MKR-> CF STEPSIZE | :CALCulate<1 2>:MARKer<1...4>:FUNction:CSTep |
| MKR-> START | :CALCulate<1 2>:MARKer<1...4>:FUNction:STARt |
| MKR-> STOP | :CALCulate<1 2>:MARKer<1...4>:FUNction:STOP |
| MKR-> TRACE | :CALCulate<1 2>:MARKer<1...4>:TRACe <num_value> :CALCulate<1 2>:DELTamarker<1...4>:TRACe <num_value> |

LINES Key Group

| | |
|-----------------------|--|
| D LINES | |
| DISPLAY LINE 1/2 | :CALCulate<1 2>:DLINe<1 2>:STATe ON OFF; :CALCulate<1 2>:DLINe<1 2> <num_value> |
| THRESHOLD LINE | :CALCulate<1 2>:THReshold ON OFF; :CALCulate<1 2>:THReshold <num_value> |
| REFERENCE LINE | :CALCulate<1 2>:RLINe:STATe ON OFF; :CALCulate<1 2>:RLINe <num_value> |
| FREQUENCY LINE 1/2 | :CALCulate<1 2>:FLINe<1 2>:STATe ON OFF; :CALCulate<1 2>:FLINe<1 2> <num_value> |
| or | |
| TIME LINE 1/2 | :CALCulate<1 2>:TLINe<1 2>:STATe ON OFF; :CALCulate<1 2>:TLINe<1 2> <num_value> |
| BASELINE CLIPPING | :CALCulate<1 2>:CTHReshold:STATe ON OFF; :CALCulate<1 2>:CTHReshold <num_value> |

| | |
|----------------------|--|
| LIMITS | |
| SELECT LIMIT LINE | :CALCulate<1 2>:LIMit<1...8>:NAME <string>; :CALCulate<1 2>:LIMit<1...8>:STATe ON OFF |
| NEW LIMIT LINE | see EDIT LIMIT LINE |
| NAME | :CALCulate<1 2>:LIMit<1...8>:NAME <string> |
| VALUES | no corresponding IEC/IEEE-bus command |

| | |
|-----------------------|---|
| INSERT VALUE | no corresponding IEC/IEEE-bus command |
| DELETE VALUE | no corresponding IEC/IEEE-bus command |
| SHIFT X LIMIT LINE | :CALCulate<1 2>:LIMit<1...8>:CONTRol:SHIFt <num_value> |
| SHIFT Y LIMIT LINE | :CALCulate<1 2>:LIMit<1...8>:UPPer:SHIFt <num_value> :CALCulate<1 2>:LIMit<1...8>:LOWer:SHIFt <num_value> |
| SAVE LIMIT LINE | automatically executed during IEC/IEEE-bus operationh |
| EDIT LIMIT LINE | :CALCulate<1 2>:LIMit<1...8>:UNIT DB DBM PCT DBUV DBMW DBUA DBPW DBPT WATT VOLT AMPere DBUV_MHZ DBMV_MHZ DBUA_MHZ DBUV_M DBUV_MMHZ DBUA_M DBUA_MMHZ :CALCulate<1 2>:LIMit<1...8>:COMMENT 'string' :CALCulate<1 2>:LIMit<1...8>:TRACe <num_value> :CALCulate<1 2>:LIMit<1...8>:CONTRol[:DATA] <num_value>, <num_value>.. :CALCulate<1 2>:LIMit<1...8>:CONTRol:DOMain FREQuency TIME :CALCulate<1 2>:LIMit<1...8>:CONTRol:OFFset <num_value> :CALCulate<1 2>:LIMit<1...8>:CONTRol:MODE RELative ABSolute :CALCulate<1 2>:LIMit<1...8>:CONTRol:SPACing LINear LOGarithmic :CALCulate<1 2>:LIMit<1...8>:UPPer[:DATA] <num_value>, <num_value>.. :CALCulate<1 2>:LIMit<1...8>:UPPer:STATe ON OFF :CALCulate<1 2>:LIMit<1...8>:UPPer:OFFset <num_value> :CALCulate<1 2>:LIMit<1...8>:UPPer:MARGin <num_value> :CALCulate<1 2>:LIMit<1...8>:UPPer:MODE RELative ABSolute :CALCulate<1 2>:LIMit<1...8>:UPPer:SPACing LINear LOGarithmic :CALCulate<1 2>:LIMit<1...8>:LOWer[:DATA] <num_value>, <num_value>.. :CALCulate<1 2>:LIMit<1...8>:LOWer:STATe ON OFF :CALCulate<1 2>:LIMit<1...8>:LOWer:OFFset <num_value> :CALCulate<1 2>:LIMit<1...8>:LOWer:MARGin <num_value> :CALCulate<1 2>:LIMit<1...8>:LOWer:MODE RELative ABSolute :CALCulate<1 2>:LIMit<1...8>:LOWer:SPACing LINear LOGarithmic :CALCulate<1 2>:LIMit<1...8>:FAIL? :CALCulate<1 2>:LIMit<1...8>:CLEar[:IMMediate] |
| COPY LIMIT LINE | :CALCulate<1 2>:LIMit<1...8>:COPY 1...8 <name> |
| DELETE LIMIT LINE | :CALCulate<1 2>:LIMit<1...8>:DELeTe |
| X OFFSET | :CALCulate<1 2>:LIMit<1...8>:CONTRol:OFFset <num_value> |
| Y OFFSET | :CALCulate<1 2>:LIMit<1...8>:UPPer:OFFset <num_value> :CALCulate<1 2>:LIMit<1...8>:LOWer:OFFset <num_value> |

TRACE Key Group

| | |
|--------------------------|--|
| TRACE 1 | |
| CLEAR/ WRITE | :DISPlay[:WINDow<1 2>]:TRACe<1...4>:MODE WRITE |
| VIEW | :DISPlay[:WINDow<1 2>]:TRACe<1...4>:MODE VIEW |
| BLANK | :DISPlay[:WINDow<1 2>]:TRACe<1...4>[:STATE] OFF |
| AVERAGE | :DISPlay[:WINDow<1 2>]:TRACe<1...4>:MODE AVERAge or :[SENSe<1 2>]:AVERAge:MODE SCALe |
| MAX HOLD | :DISPlay[:WINDow<1 2>]:TRACe<1...4>:MODE MAXHold or :[SENSe<1 2>]:AVERAge:MODE MAX |
| MIN HOLD | :DISPlay[:WINDow<1 2>]:TRACe<1...4>:MODE MINHold or :[SENSe<1 2>]:AVERAge:MODE MIN |
| HOLD CONT ON/OFF | :DISPlay[:WINDow<1 2>]:TRACe<1...4>:MODE:HCONTinuous ON OFF |
| SWEEP COUNT | :[SENSe<1 2>]:SWEep:COUNT <num_value> |
| DETECTOR | -- |
| AUTO SELECT | :[SENSe<1 2>]:DETEctor<1...4>[:FUNction]:AUTO ON OFF |
| DETECTOR AUTOPEAK | :[SENSe<1 2>]:DETEctor<1...4>[:FUNction] APEak |
| DETECTOR MAX PEAK | :[SENSe<1 2>]:DETEctor<1...4>[:FUNction] POSitive |
| DETECTOR MIN PEAK | :[SENSe<1 2>]:DETEctor<1...4>[:FUNction] NEGative |
| DETECTOR SAMPLE | :[SENSe<1 2>]:DETEctor<1...4>[:FUNction] SAMPLe |
| DETECTOR RMS | :[SENSe<1 2>]:DETEctor<1...4>[:FUNction] RMS |
| DETECTOR AVERAGE | :[SENSe<1 2>]:DETEctor<1...4>[:FUNction] AVERAge |
| COPY.. | TRACe:COpy TRACE1 TRACE2 TRACE3 TRACE4 , TRACE1 TRACE2 TRACE3 TRACE4 |
| ANALOG TR ON/OFF | :DISPlay[:WINDow<1 2>]:TRACe<1...4>:MODE:ANALog ON OFF |
| TRACE MATH | -- |
| T1-T2/T3/T4 +REF ->T1 | :CALCulate<1 2>:MATH<1...4>:STATe ON :CALCulate<1 2>:MATH<1...4>[:EXPRession][:DEFine] <expr> |
| T1-REF ->T1 | :CALCulate<1 2>:MATH<1...4>:STATe ON :CALCulate<1 2>:MATH<1...4>[:EXPRession][:DEFine] <expr> |

| | |
|---------------------|---|
| ADJUST TO TRACE | no corresponding IEC/IEEE-bus command |
| TRACE MATH OFF | :CALCulate<1 2>:MATH<1...4>:STATE OFF |
| ASCII EXPORT | :MMEMory:STORe:TRACe 1...4,<path with file name> |
| ASCII CONFIG | -- |
| EDIT PATH | the path is included in command MMEMory:STORe:TRACe |
| DECIM SEP . / | FORMat:DEXPort:DSEPARATOR POINT COMMA |
| NEW APPEND | FORMat:DEXPort:APPend[:STATE] ON OFF |
| HEADER ON OFF | FORMat:DEXPort:HEADer[:STATE] ON OFF |
| ASCII COMMENT | FORMat:DEXPort:COMment ,comment` |

SWEEP Key Group

| | |
|-------------------------|--|
| COUPLING | |
| RES BW MANUAL | : [SENSe<1 2>:]BANDwidth BWIDth[:RESolution] <num_value> |
| RES BW AUTO | : [SENSe<1 2>:]BANDwidth BWIDth[:RESolution]:AUTO ON OFF |
| VIDEO BW MANUAL | : [SENSe<1 2>:]BANDwidth BWIDth:VIDeo <num_value> |
| VIDEO BW AUTO | : [SENSe<1 2>:]BANDwidth BWIDth:VIDeo:AUTO ON OFF |
| SWEEP TIME MANUAL | : [SENSe<1 2>:]SWEep:TIME <num_value> |
| SWEEP TIME AUTO | : [SENSe<1 2>:]SWEep:TIME:AUTO ON OFF |
| COUPLING DEFAULT | : [SENSe<1 2>:]BANDwidth BWIDth[:RESolution]:AUTO ON; : [SENSe<1 2>:]BANDwidth BWIDth:VIDeo:AUTO ON; : [SENSe<1 2>:]SWEep:TIME:AUTO ON |
| COUPLING RATIO | : [SENSe<1 2>:]BANDwidth BWIDth[:RESolution]:RATio 0.02 : [SENSe<1 2>:]BANDwidth BWIDth:VIDeo:RATio SINE |
| RBW / VBW SINE [1] | : [SENSe<1 2>:]BANDwidth BWIDth:VIDeo:RATio SINE |
| RBW / VBW PULSE [.1] | : [SENSe<1 2>:]BANDwidth BWIDth:VIDeo:RATio PULSe |
| RBW / VBW NOISE [10] | : [SENSe<1 2>:]BANDwidth BWIDth:VIDeo:RATio NOISe |
| RBW / VBW MANUAL | : [SENSe<1 2>:]BANDwidth BWIDth:VIDeo:RATio <num_value> |
| SPAN / RBW AUTO [50] | : [SENSe<1 2>:]BANDwidth BWIDth[:RESolution]:RATio 0.02 |
| SPAN / RBW MANUAL | : [SENSe<1 2>:]BANDwidth BWIDth[:RESolution]:RATio <num_value> |
| RBW 1kHz ANA/DIG | : [SENSe<1 2>:]BANDwidth BWIDth[:RESolution]:MODE ANALog DIGital |
| RBW <=1kHz FFT/NORM | : [SENSe<1 2>:]BANDwidth BWIDth[:RESolution]:MODE:FFT ON OFF |
| MAIN PLL BANDWIDTH | : [SENSe<1 2>:]BANDwidth BWIDth:PLL AUTO HIGH MEDIum LOW |
| TRIGGER | |
| FREE RUN | : TRIGger<1 2>[:SEquence]:SOURce IMMEDIATE |
| VIDEO | : TRIGger<1 2>[:SEquence]:SOURce VIDeo : TRIGger<1 2>[:SEquence]:LEVel:VIDeo <num_value> |

| | |
|----------------------|--|
| LINE | :TRIGger<1 2>[:SEquence]:SOURce LINE |
| EXTERN | :TRIGger<1 2>[:SEquence]:SOURce EXTernal :TRIGger<1 2>[:SEquence]:LEVel[:EXTernal] -5.0...+5.0V |
| RF POWER | :TRIGger<1 2>[:SEquence]:SOURce RFPower |
| TRIGGER DELAY | :TRIGger<1 2>[:SEquence]:HOLDoff <num_value> |
| SLOPE POS/NEG | :TRIGger<1 2>[:SEquence]:SLOPe POSitive NEGative |
| SWEEP | |
| CONTINUOUS SWEEP | :INITiate<1 2>:CONTinuous ON; :INITiate<1 2>[:IMMediate] |
| SINGLE SWEEP | :INITiate<1 2>:CONTinuous OFF; :INITiate<1 2>[:IMMediate] |
| SWEEP TIME AUTO | :[SENSe<1 2>:]SWEep:TIME:AUTO ON OFF |
| SWEEP TIME MANUAL | :[SENSe<1 2>:]SWEep:TIME <num_value> |
| SWEEP COUNT | :[SENSe<1 2>:]SWEep:COUNT <num_value> |
| GAP SWEEP ON/OFF | :[SENSe<1 2>:]SWEep:GAP ON OFF |
| GAP SWEEP SETTINGS | -- |
| TRIGGER LEVEL | :TRIGger<1 2>[:SEquence]:LEVel:VIDeo <num_value> |
| PRE TRIGGER | :[SENSe<1 2>:]SWEep:GAP:PRETrigger <num_value> |
| TRG TO GAP TIME | :[SENSe<1 2>:]SWEep:GAP:TRGTogap <num_value> |
| GAP LENGTH | :[SENSe<1 2>:]SWEep:GAP:LENGth <num_value> |
| GATE ON / OFF | :[SENSe<1 2>:]SWEep:EGATE ON OFF |
| GATE SETTINGS | -- |
| GATE LEVEL | :[SENSe<1 2>:]SWEep:EGATE:LEVel <num_value> |
| GATE MODE LEVEL/EDGE | :[SENSe<1 2>:]SWEep:EGATE:TYPE LEVel EDGE |
| GATE POL POS/NEG | :[SENSe<1 2>:]SWEep:EGATE:POLarity POSitive NEGative |
| GATE DELAY | :[SENSe<1 2>:]SWEep:EGATE:HOLDoff <num_value> |

| | |
|-------------------------|---|
| GATE LENGTH | : [SENSe<1 2>:]SWEep:EGATe:LENGTh <num_value> |
| GATE EXTERN | : [SENSe<1 2>:]SWEep:EGATe:SOURce EXTernal |
| GATE RF POWER | : [SENSe<1 2>:]SWEep:EGATe:SOURce RFPower |
| GATE ADJUST | |
| GATE LEVEL | : [SENSe<1 2>:]SWEep:EGATe:LEVel <num_value> |
| GATE MODE LEVEL/EDGE | : [SENSe<1 2>:]SWEep:EGATe:TYPE LEVel EDGE |
| GATE POL POS/NEG | : [SENSe<1 2>:]SWEep:EGATe:POLarity POSitive NEGative |
| GATE DELAY | : [SENSe<1 2>:]SWEep:EGATe:HOLDOff <num_value> |
| GATE LENGTH | : [SENSe<1 2>:]SWEep:EGATe:LENGTh <num_value> |
| SWEEP TIME MANUAL | : [SENSe<1 2>:]SWEep:TIME <num_value> |
| RES BW MANUAL | : [SENSe<1 2>:]BANDwidth BWIDth[:RESolution] <num_value> |
| VIDEO MANUAL | : [SENSe<1 2>:]BANDwidth BWIDth:VIDeo <num_value> |
| VIDEO AUTO | : [SENSe<1 2>:]BANDwidth BWIDth:VIDeo:AUTO ON OFF |
| SGL SWEEP DISP OFF | : INITiate<1 2>:DISPlay ON OFF : INITiate<1 2>[:IMMediate] |

Basic Instrument - General Device Settings

DATA VARIATION Key Group

| | |
|---------------------|---|
| HOLD | |
| UNLOCK | no corresponding IEC/IEEE-bus command |
| LOCK DATA | no corresponding IEC/IEEE-bus command |
| LOCK ALL | no corresponding IEC/IEEE-bus command |
| | |
| STEP | if needed, the step width is entered in the subsystem of the corresponding parameter. |
| STEP SIZE AUTO | -- |
| STEP SIZE MANUAL | -- |

SYSTEM Key Group

| | |
|-----------------------|---|
| DISPLAY | |
| FULL SCREEN | DISPlay:FORMat SINGLE |
| SPLIT SCREEN | DISPlay:FORMat SPLit |
| ACTIVE SCREEN A | The screen is selected via the numeric suffix of the individual commands. |
| SCREEN COUPLING | -- |
| MODE COUPLED | :INSTrument<1 2>:COUPlE MODE |
| HORIZONTAL SCALING | ::INSTrument<1 2>:COUPlE X |
| VERTICAL SCALING | ::INSTrument<1 2>:COUPlE Y |
| COUPLING CONTROL | ::INSTrument<1 2>:COUPlE CONTRol |
| SCREENS UNCOUPLED | ::INSTrument<1 2>:COUPlE NONE ALL |

| | |
|----------------------|---|
| CONFIG DISPLAY | -- |
| SELECT OBJECT | -- |
| BRIGHTNESS | DISPlay:CMAP:HSL <hue>,<sat>,<lum> |
| TINT | DISPlay:CMAP<1...13>:HSL <hue>,<sat>,<lum> |
| SATURATION | DISPlay:CMAP<1...13>:HSL <hue>,<sat>,<lum> |
| DEFAULT COLORS | DISPlay:CMAP<1...13>:DEFault |
| PREDEFINED COLORS | DISPlay:CMAP<1...13>:PDEFined BLACK BLUE BROWN GREEN CYAN RED MAGenta YELLow WHITE DGRAY LGRAY LBLUe LGREen LCYan LRED LMAGenta |
| LOGO ON/OFF | DISPlay:LOGO ON OFF |
| FREQUENCY ON/OFF | DISPlay:ANNotation:FREQUency ON OFF |
| DATA ENTRY FIELD | -- |
| DATAENTRY X | no corresponding IEC/IEEE-bus command |
| DATAENTRY Y | no corresponding IEC/IEEE-bus command |
| DEFAULT POSITION | no corresponding IEC/IEEE-bus command |
| DATAENTRY OPAQUE | no corresponding IEC/IEEE-bus command |
| TIME ON OFF | :DISPlay[:WINDow<1 2>]:TIME ON OFF |
| DISPLAY COMMENT | :DISPlay[:WINDow<1 2>]:TEXT[:DATA] <string> :DISPlay[:WINDow<1 2>]:TEXT:STATE ON OFF |
| SCR.SAVER ON OFF | DISPlay:PSAVer[:STATE] ON OFF |
| SCR.SAVER TIME | DISPlay:PSAVer:HOLDoff <num_value> |
| CAL | |
| CAL SHORT | CALibration:SHORT? |
| CAL TOTAL | CALibration[:ALL]? |
| CAL RES BW | CALibration:BANDwidth BWIDth[:RESolution]? |

| | |
|-----------------------|--|
| CAL LOG | CALibration:LDEtector? |
| CAL LO SUPP | CALibration:LOSuppression? |
| CAL I/Q | CALibration:IQ? |
| CAL CORR ON/OFF | CALibration:STATE ON OFF |
| CAL RESULTS | no corresponding IEC/IEEE-bus command |
| PRESEL PEAK | CALibration:PPEak? |
| INFO | |
| FIRMWARE VERSION | *IDN? |
| HARDWARE+ OPTIONS | *OPT? :SYSTem:BINFo? |
| SELFTTEST | *TST? |
| EXECUTE TEST | *TST? |
| SYSTEM MESSAGES | :SYSTem:ERRor? |
| CLEAR MESSAGE | :SYSTem:ERRor? |
| CLEAR ALL MESSAGES | -- |
| UPDATE MESSAGES | -- |
| OPTIONS | *OPT? |
| STATISTIC | -- |
| ATT SWITCHES | Query of number of switches operations for the attenuator: :DIAGnostic:INFO:CCOunt:ATTenuation<1 2 3> |

CONFIGURATION Key Group

| | |
|--------------------|--|
| MODE | The submenus are described at the corresponding operating mode. |
| ANALYZER | :INSTRument<1 2>[:SElect] SANalyzer :INSTRument<1 2>:NSElect 1 |
| TRACKING GENERATOR | OUTPut[:STATE] ON OFF |
| VECTOR ANALYZER | :INSTRument<1 2>[:SElect] ADEMod DDEMod :INSTRument<1 2>:NSElect 2 3 |
| TV DEMOD | :[SENSe<1 2>:]TV[:STATE] ON OFF |
| GSM MS ANALYZER | :INSTRument<1 2>[:SElect] MGSM :INSTRument<1 2>:NSElect 5 |
| GSM BTS ANALYZER | :INSTRument<1 2>[:SElect] BGSM :INSTRument<1 2>:NSElect 4 |
| | |
| SETUP | |
| TRANSDUCER | -- |
| TRANSDUCER FACTOR | :[SENSe<1 2>:]CORRection:TRANSDUCER:SElect <name> :[SENSe<1 2>:]CORRection:TRANSDUCER[:STATE] ON OFF |
| TRANSDUCER SET | :[SENSe<1 2>:]CORRection:TSET:SElect <name> :[SENSe<1 2>:]CORRection:TSET[:STATE] ON OFF |
| EDIT TRD FACTOR | :[SENSe<1 2>:]CORRection:TRANSDUCER:SCALing LINear LOGarithmic :[SENSe<1 2>:]CORRection:TRANSDUCER:COMMENT <string> |
| TRD FACTOR NAME | :[SENSe<1 2>:]CORRection:TRANSDUCER:SElect <name> |
| TRD FACTOR UNIT | :[SENSe<1 2>:]CORRection:TRANSDUCER:UNIT <string> |
| TRD FACTOR VALUES | :[SENSe<1 2>:]CORRection:TRANSDUCER:DATA <freq>,<level>.. |
| INSERT LINE | no corresponding IEC/IEEE-bus command |
| DELETE LINE | no corresponding IEC/IEEE-bus command |
| SAVE TRD FACTOR | automatically executed during IEC/IEEE-bus operationh |
| EDIT TRD SET | :[SENSe<1 2>:]CORRection:TSET:BREak ON OFF :[SENSe<1 2>:]CORRection:TSET:COMMENT <string> |
| TRANSD SET NAME | :[SENSe<1 2>:]CORRection:TSET:SElect <name> |
| TRANSD SET UNIT | :[SENSe<1 2>:]CORRection:TSET:UNIT <string> |

| | |
|--------------------------|--|
| TRANS D SET RANGES | :[SENSe<1 2>:]CORRection:TSET:RANGe<1...10> <freq>,<freq1>,<name>.. |
| INSERT LINE | no corresponding IEC/IEEE-bus command |
| DELETE LINE | no corresponding IEC/IEEE-bus command |
| SAVE TRD SET | automatically executed during IEC/IEEE-bus operationh |
| NEW FACT/SET | see EDIT TRD FACTOR or EDIT TRD SET |
| DELETE FACTOR/SET | :[SENSe<1 2>:]CORRection:TRANsducer:DELeTe :[SENSe<1 2>:]CORRection:TSET:DELeTe |
| OPTIONS | no corresponding IEC/IEEE-bus command |
| REFERENCE INT/EXT | :[SENSe<1 2>:]ROSCillator:SOURce INTernal EXTernal |
| EXT REF FREQUENCY | :[SENSe<1 2>:]ROSCillator:EXTernal:FREQuency <num_value> |
| SERVICE | -- |
| INPUT RF | :DIAGnostic:SERvice:INPut[:SELeCt] RF |
| INPUT CAL | :DIAGnostic:SERvice:INPut[:SELeCt] CALibration |
| NOISE SOURCE | :DIAGnostic:SERvice:NSOURce ON OFF |
| REFERENCE ADJUST | -- |
| REFERENCE | :[SENSe<1 2>:]ROSCillator:[INTernal:]TUNE <num_value> |
| REFERENCE PROG | :[SENSe<1 2>:]ROSCillator:[INTernal:]TUNE:SAVe |
| SERVICE FUNCTION | :DIAGnostic:SERvice:FUNCTion <num_value>,<num_value>... |
| ENTER PASSWORD | :SYSTem:PASSword[:CENable] <string> |
| GENERAL SETUP | -- |
| GPIB ADDRESS | :SYSTem:COMMunicate:GPIB[:SELF]:ADDRess 0...30 |
| USER PORT A/B | :INPut<1 2>:UPOrt<1 2>[:VALue]? :INPut<1 2>:UPOrt<1 2>:STATe ON OFF :OUTPut<1 2>:UPOrt<1 2>:STATe ON OFF :OUTPut<1 2>:UPOrt<1 2>[:VALue] <Binary> |

| | |
|----------------------|---|
| COM PORT 1 / 2 | <pre>:SYSTem:COMMunicate:SERial<1 2>:CONTrol:DTR IBFull OFF :SYSTem:COMMunicate:SERial<1 2>:CONTrol:RTS IBFull OFF :SYSTem:COMMunicate:SERial<1 2>[:RECeive]:BAUD <num_value> :SYSTem:COMMunicate:SERial<1 2>[:RECeive]:BITS 7 8 :SYSTem:COMMunicate:SERial<1 2>[:RECeive]:PARity[:TYPE] EVEN ODD NONE :SYSTem:COMMunicate:SERial<1 2>[:RECeive]:SBITs 1 2 :SYSTem:COMMunicate:SERial<1 2>[:RECeive]:PACE XON NONE</pre> |
| TIME | <pre>:SYSTem:TIME 0...23, 0...59, 0...59</pre> |
| DATE | <pre>:SYSTem:DATE <num>, <num>, <num></pre> |
| MOUSE | no corresponding IEC/IEEE-bus command (not FSE with Windows NT) |
| EXTERNAL KEYBOARD | no corresponding IEC/IEEE-bus command (not FSE with Windows NT) |
| MONITOR CONNECTED | no corresponding IEC/IEEE-bus command (FSE with Windows NT only) |
| KEY CLICK ON/OFF | no corresponding IEC/IEEE-bus command |
| FIRMWARE UPDATE | no corresponding IEC/IEEE-bus command |

STATUS Key Group

| | |
|-------|------------------------------------|
| LOCAL | Device message "Go to LOCAL (GTL)" |
|-------|------------------------------------|

HARDCOPY Key Group

| | |
|------------------------|---|
| START | :HCOPY[:IMMEDIATE<1 2>] |
| SETTINGS | |
| COPY SCREEN | :HCOPY:ITEM:ALL |
| COPY TRACE | :HCOPY:ITEM:WINDOW<1 2>:TRACE:STATE ON OFF |
| COPY TABLE | :HCOPY:ITEM:WINDOW<1 2>:TABLE:STATE ON OFF |
| SELECT QUADRANT | -- |
| UPPER LEFT | :HCOPY:PAGE:DIMENSIONS:QUADRANT 1 |
| LOWER LEFT | :HCOPY:PAGE:DIMENSIONS:QUADRANT 2 |
| UPPER RIGHT | :HCOPY:PAGE:DIMENSIONS:QUADRANT 3 |
| LOWER RIGHT | :HCOPY:PAGE:DIMENSIONS:QUADRANT 4 |
| FULL PAGE | :HCOPY:PAGE:DIMENSIONS:FULL |
| ENTER TEXT | -- |
| COMMENT SCREEN A/B | :HCOPY:ITEM:WINDOW<1 2>:TEXT <string> |
| TITLE | :HCOPY:ITEM:LABEL:TEXT <string> |
| HARDCOPY DEVICE | :HCOPY:DEVICE:LANGUAGE WMF EMMF BMP GDI (FSE with Windows NT) :HCOPY:DEVICE:LANGUAGE HPGL PCL4 PCL5 POSTscript ESCP WMF PCX HP7470 EPSON24 EPSON24C PCL4_C PCL4_C3 LASERJ DESKJ DESKJ_C DESKJ_C3 HPGL_LS HP7470LS (FSE with DOS or without controller) |
| SETTINGS DEVICE 1/2 | :HCOPY:DESTINATION<1 2> <string> :MMEMORY:NAME <file_name> :HCOPY:ITEM:FFEEED<1 2>:STATE ON OFF :HCOPY:PAGE:ORIENTATION<1 2> LANDSCAPE PORTRAIT :HCOPY:DEVICE:PRESET<1 2> ON OFF (FSE with DOS or without controller) :HCOPY:DEVICE:RESOLUTION<1 2> 150 300 (FSE with DOS or without controller) |
| ENABLE DEV1/DEV2 | the numeric suffix after HCOPIY:IMMEDIATE denotes the first or second device. |
| COLOR ON/OFF | :HCOPY:DEVICE:COLOR ON OFF |
| TRC COLOR AUTO INC | :HCOPY:ITEM:WINDOW<1 2>:TRACE:CAINCREMENT ON OFF |

MEMORY Key Group

| | |
|----------------------|---|
| CONFIG | |
| EDIT PATH | :MMEMory:MSIS <device> :MMEMory:CDIRectory <directory_name> |
| DELETE | :MMEMory:DELeTe <file_name> :MMEMory:RDIRectory <directory_name> |
| FORMAT DISK | :MMEMory:INITialize <msus> |
| MAKE DIRECTORY | :MMEMory:MDIRectory <directory_name> |
| RENAME | :MMEMory:MOVE <file_source>,<file_destination> |
| SORT MODE | no corresponding IEC/IEEE-bus command |
| COPY | :MMEMory:COpy <file_source>,<file_destination> |
| SAVE | |
| EDIT NAME | :MMEMory:STORe:STATe 1,<file_name> |
| EDIT PATH | the path is included in the file name. |
| EDIT COMMENT | :MMEMory:COMMeNt <string> |
| SELECT ITEMS TO SAVE | -- |
| SELECT ITEMS | :MMEMory:SElect[:ITEM]:GSETup ON OFF :MMEMory:SElect[:ITEM]:HWSettings ON OFF :MMEMory:SElect[:ITEM]:TRACe<1..4> ON OFF :MMEMory:SElect[:ITEM]:LINES[:ACTive] ON OFF :MMEMory:SElect[:ITEM]:LINES:ALL ON OFF :MMEMory:SElect[:ITEM]:CSETup ON OFF :MMEMory:SElect[:ITEM]:HCOpy ON OFF :MMEMory:SElect[:ITEM]:MACRos ON OFF :MMEMory:SElect[:ITEM]:SCData ON OFF :MMEMory:SElect[:ITEM]:TRANsducer[:ACTive] ON OFF :MMEMory:SElect[:ITEM]:TRANsducer:ALL ON OFF :MMEMory:SElect[:ITEM]:CVL[:ACTive] ON OFF :MMEMory:SElect[:ITEM]:CVL:ALL ON OFF |
| ENABLE ALL ITEMS | :MMEMory:SElect[:ITEM]:ALL |
| DISABLE ALL ITEMS | :MMEMory:SElect[:ITEM]:NONE |
| DEFAULT CONFIG | :MMEMory:SElect[:ITEM]:DEFault |
| DATA SET LIST | -- |

| | |
|---------------------------|---|
| DATA SET CLEAR | :MMEMemory:CLEAr:STATe 1,<file_name> |
| DATA SET CLEAR ALL | :MMEMemory:CLEAr:ALL |
| RECALL | |
| EDIT NAME | :MMEMemory:LOAD:STATe 1,<file_name> |
| EDIT PATH | the path is included in the file name. |
| AUTO RECALL | :MMEMemory:LOAD:AUTO 1,<file_name> |
| SELECT ITEMS TO RECALL | -- |
| SELECT ITEMS | :MMEMemory:SElect[:ITEM]:GSETup ON OFF :MMEMemory:SElect[:ITEM]:HWSettings ON OFF :MMEMemory:SElect[:ITEM]:TRACe<1...4> ON OFF :MMEMemory:SElect[:ITEM]:LINES[:ACTiVe] ON OFF :MMEMemory:SElect[:ITEM]:LINES:ALL ON OFF :MMEMemory:SElect[:ITEM]:CSETup ON OFF :MMEMemory:SElect[:ITEM]:HCOPY ON OFF :MMEMemory:SElect[:ITEM]:CDATA ON OFF :MMEMemory:SElect[:ITEM]:MACROs ON OFF :MMEMemory:SElect[:ITEM]:SCData ON OFF :MMEMemory:SElect[:ITEM]:TRANSDUCER[:ACTiVe] ON OFF :MMEMemory:SElect[:ITEM]:TRANSDUCER:ALL ON OFF :MMEMemory:SElect[:ITEM]:CVL[:ACTiVe] ON OFF :MMEMemory:SElect[:ITEM]:CVL:ALL ON OFF |
| ENABLE ALL ITEMS | :MMEMemory:SElect[:ITEM]:ALL |
| DISABLE ALL ITEMS | :MMEMemory:SElect[:ITEM]:NONE |
| DEFAULT CONFIG | :MMEMemory:SElect[:ITEM]:DEFault |
| DATA SET LIST | -- |
| DATA SET CLEAR | :MMEMemory:CLEAr:STATe 1,<file_name> |
| DATA SET CLEAR ALL | :MMEMemory:CLEAr:ALL |

USER Key

| | |
|------------------|---------------------------------------|
| USER | |
| MACRO 1...7 | no corresponding IEC/IEEE-bus command |
| DEFINE MACRO | no corresponding IEC/IEEE-bus command |
| RECORD ON/OFF | no corresponding IEC/IEEE-bus command |
| DEFINE PAUSE | no corresponding IEC/IEEE-bus command |
| DELETE MACRO | no corresponding IEC/IEEE-bus command |
| MACRO TITLE | no corresponding IEC/IEEE-bus command |
| SELECT MACRO | no corresponding IEC/IEEE-bus command |

Operating Mode Vector-Signal Analyzer (Option FSE-B7)

CONFIGURATION Key Group - Digital Demodulation

| | |
|----------------------|---|
| MODE | -- |
| VECTOR ANALYZER | -- |
| DIGITAL STANDARD | |
| PWT WCFE | :[SENSe<1 2>:]DDEMod:PRESet PWT |
| IS-95 CDMA FWD CH | :[SENSe<1 2>:]DDEMod:PRESet F95Cdma FQCDma |
| IS-95 CDMA REV CH | :[SENSe<1 2>:]DDEMod:PRESet R95Cdma RQCDma |
| APCO25 C4FM | :[SENSe<1 2>:]DDEMod:PRESet APCO25C4FM |
| APCO25 CQPSK | :[SENSe<1 2>:]DDEMod:PRESet APCO25CQPSK |
| NADC REV CH | :[SENSe<1 2>:]DDEMod:PRESet RNADc |
| PDC UP | :[SENSe<1 2>:]DDEMod:PRESet PDCup |
| TFTS | :[SENSe<1 2>:]DDEMod:PRESet TFTS |
| GSM | :[SENSe<1 2>:]DDEMod:PRESet GSM DCS1800 PCS1900 |
| EDGE | :[SENSe<1 2>:]DDEMod:PRESet EDGE |
| NADC FWD CH | :[SENSe<1 2>:]DDEMod:PRESet FNADc |
| CDPD | :[SENSe<1 2>:]DDEMod:PRESet CDPD |
| DECT | :[SENSe<1 2>:]DDEMod:PRESet DECT |
| CT2 | :[SENSe<1 2>:]DDEMod:PRESet CT2 |
| PDC DOWN | :[SENSe<1 2>:]DDEMod:PRESet PDCDown |
| PHS | :[SENSe<1 2>:]DDEMod:PRESet PHS |
| TETRA | :[SENSe<1 2>:]DDEMod:PRESet TETRa |
| ERMES | :[SENSe<1 2>:]DDEMod:PRESet ERMes |

| | |
|-----------------------|--|
| MODACOM | : [SENSe<1 2>:]DDEMod:PRESet MODacom |
| FLEX16_2 | : [SENSe<1 2>:]DDEMod:PRESet F16 |
| FLEX32_2 | : [SENSe<1 2>:]DDEMod:PRESet F322 |
| FLEX32_4 | : [SENSe<1 2>:]DDEMod:PRESet F324 |
| FLEX64_4 | : [SENSe<1 2>:]DDEMod:PRESet F64 |
| DIGITAL DEMOD | <pre> ::INSTRument[:SElect] DDEMod :[SENSe<1 2>:]DDEMod:FORMat QPSK PSK MSK QAM FSK :[SENSe<1 2>:]DDEMod:QPSK:FORMat NORMal DIFFerential OFFSet DPI4 :[SENSe<1 2>:]DDEMod:PSK:NState 2 8 :[SENSe<1 2>:]DDEMod:PSK:FORMat NORMal DIFFerential N3Pi8 :[SENSe<1 2>:]DDEMod:MSK:FORMat TYPE1 TYPE2 NORMal DIFFerential :[SENSe<1 2>:]DDEMod:QAM:NState 16 :[SENSe<1 2>:]DDEMod:FSK:NState 2 4 </pre> <p>Querying the results:</p> <pre> :CALCulate<1 2>:MARKer<1 2>:FUNCTION:DDEMod:RESult? MERM MEPK MEPS PERM PEPK PEPS EVRM EVPK EVPS IQOF IQIM ADR FERR DEV FSRM FSPK FSPS RHO FEPK :CALCulate<1 2>:MARKer<1 2>:FUNCTION:Y? :TRACe:DATA? </pre> |
| MODULATION PARAMETERS | -- |
| SYMBOL RATE | : [SENSe<1 2>:]DDEMod:SRATE <num_value> |
| SIDE BAND NORM INV | : [SENSe<1 2>:]DDEMod:SBAND NORMal INVerse |
| MEAS FILTER | <pre> :[SENSe<1 2>:]DDEMod:FILTer:MEASurement OFF RCOSine RRCosine GAUSSian B22 B25 B44 QFM FM95 QFR FR95 QRM RM95 QRR RR95 A25Fm EMES EREF </pre> |
| REFERENCE FILTER | <pre> :[SENSe<1 2>:]DDEMod:FILTer:REFerence RCOSine RRCosine GAUSSian B22 B25 B44 QFM FM95 QFR FR95 QRM RM95 QRR RR95 A25Fm EMES EREF </pre> |
| ALPHA/BT | : [SENSe<1 2>:]DDEMod:FILTer:ALPha <num_value> |
| FSK REF DEVIATION | : CALCulate<1 2>:FSK:DEVIation:REFerence <num_value> |
| NORMALIZE ON / OFF | : [SENSe<1 2>:]DDEMod:NORMalize ON OFF |
| MEAS RESULT | -- |
| MAGNITUDE CAP BUFFER | : CALCulate<1 2>:FEED `TCAP` |
| MEAS SIGNAL | <pre> :CALCulate<1 2>:FEED `XTIM:DDEM:MEAS` </pre> <p>Querying the results:</p> <pre> :CALCulate<1 2>:MARKer<1 2>:FUNCTION:DDEMod:RESult? MERM MEPK MEPS PERM PEPK PEPS EVRM EVPK EVPS IQOF IQIM ADR FERR DEV FSRM FSPK FSPS RHO FEPK </pre> <p>The following commands select the display mode:</p> |
| MAGNITUDE | : CALCulate<1 2>:FORMat MAGNitude |

| | |
|---------------------|---|
| PHASE | :CALCulate<1 2>:FORMat PHASe |
| FREQUENCY | :CALCulate<1 2>:FORMat FREQuency |
| REAL/IMAG PART | :CALCulate<1 2>:FORMat RIMag |
| EYE DIAG [FREQ] | :CALCulate<1 2>:FORMat FEYE |
| EYE DIAG [I] | :CALCulate<1 2>:FORMat IEYE |
| EYE DIAG [Q] | :CALCulate<1 2>:FORMat QEYE |
| EYE DIAG TRELIS | :CALCulate<1 2>:FORMat TEYE |
| POLAR [IQ] VECTOR | :CALCulate<1 2>:FORMat COMP |
| POLAR [IQ] CONSTELL | :CALCulate<1 2>:FORMat CONS |
| SYMBOL DISPLAY | :DISPlay[:WINDow<1 2>]:TRACe<1...4>:SYMBol DOTS BARS OFF |
| PHASE WRAP ON/OFF | :CALCulate<1 2>:FORMat PHASe UPHase |
| EYE LENGTH | :DISPlay[:WINDow<1 2>]:TRACe<1...4>:EYE:COUNT <num_value> |

REFERENCE SIGNAL :CALCulate<1|2>:FEED `XTIM:DDEM:REF`
Querying the results:
 :CALCulate<1|2>:MARKer<1|2>:FUNctIon:DDEMod:RESult? MERM| MEPK| MEPS| PERM| PEPK| PEPS| EVRM| EVPK| EVPS| IQOF| IQIM| ADR| FERR| DEV| FSRM| FSPK| FSPS| RHO| FEPK

The following commands select the display mode:

| | |
|---------------------|----------------------------------|
| MAGNITUDE | :CALCulate<1 2>:FORMat MAGNitude |
| PHASE | :CALCulate<1 2>:FORMat PHASe |
| FREQUENCY | :CALCulate<1 2>:FORMat FREQuency |
| REAL/IMAG PART | :CALCulate<1 2>:FORMat RIMag |
| EYE DIAG [FREQ] | :CALCulate<1 2>:FORMat FEYE |
| EYE DIAG [I] | :CALCulate<1 2>:FORMat IEYE |
| EYE DIAG [Q] | :CALCulate<1 2>:FORMat QEYE |
| EYE DIAG TRELIS | :CALCulate<1 2>:FORMat TEYE |
| POLAR [IQ] VECTOR | :CALCulate<1 2>:FORMat COMP |
| POLAR [IQ] CONSTELL | :CALCulate<1 2>:FORMat CONS |

| | |
|----------------------|---|
| SYMBOL DISPLAY | :DISPlay[:WINDow<1 2>]:TRACe<1...4>:SYMBol DOTS BARS OFF |
| PHASE WRAP ON/OFF | :CALCulate<1 2>:FORMat PHASe UPHase |
| EYE LENGTH | :DISPlay[:WINDow<1 2>]:TRACe<1...4>:EYE:COUNT <num_value> |
| ERROR SIGNAL | :CALCulate<1 2>:FEED `XTIM:DDEM:ERR:MPH` (Querying the results) :CALCulate<1 2>:MARKer<1 2>:FUNCTION:DDEMod:RESult? MERM MEPK MEPS PERM PEPK PEPS EVRM EVPK EVPS IQOF IQIM ADR FERR DEV FSRM FSPK FSPS RHO FEPK |

The following commands select the display mode:

| | |
|-------------------------|---|
| MAGNITUDE | :CALCulate<1 2>:FORMat MAGNitude |
| PHASE | :CALCulate<1 2>:FORMat PHASe |
| FREQUENCY | :CALCulate<1 2>:FORMat FREQuency |
| REAL/IMAG PART | :CALCulate<1 2>:FORMat RIMag |
| ERROR VECT MAGNITUDE | :CALCulate<1 2>:FORMat MAGNitude :CALCulate<1 2>:FEED `XTIM:DDEM:ERR:VECT` |
| POLAR [IQ] VECTOR | :CALCulate<1 2>:FORMat COMP :CALCulate<1 2>:FEED `XTIM:DDEM:ERR:VECT` |
| POLAR [IQ] CONSTELL | :CALCulate<1 2>:FORMat CONS :CALCulate<1 2>:FEED `XTIM:DDEM:ERR:VECT` |
| SYMBOL DISPLAY | :DISPlay[:WINDow<1 2>]:TRACe<1...4>:SYMBol DOTS BARS OFF |
| SYMB TABLE / ERRORS | :CALCulate<1 2>:FEED `XTIM:DDEM:SYMB` |
| MEMORY SIZE | :[SENSe<1 2>]:TCApTure:LENGth 1024 2048 4096 8192 16384 |
| FRAME LENGTH | :[SENSe<1 2>]:DDEMod:SEARch:TIME <num_value> |
| RESULT LENGTH | :[SENSe<1 2>]:DDEMod:TIME <num_value> |
| POINTS PER SYMBOL | :[SENSe<1 2>]:DDEMod:PRATe 1 2 4 8 16 |
| TRIGGER | see section "SWEEP - TRIGGER" |
| RANGE | see section "LEVEL - RANGE" |
| IF BANDWIDTH | -- |
| IF BW AUTO | :[SENSe<1 2>]:BANDwidth BWIth:RESolution:AUTO ON OFF |
| IF BW MANUAL | :[SENSe<1 2>]:BANDwidth BWIth:RESolution <num_value> |

CONFIGURATION Key Group - Analog Demodulation

| | |
|----------------------|---|
| MODE | -- |
| VECTOR ANALYZER | -- |
| ANALOG DEMOD | ::INSTRument<1 2>[:SElect] ADEMod |
| MODULATION PARAMETER | -- |
| HIGH PASS AF FILTER | SENSe<1 2>:FILTer:HPASs[:STATe] ON OFF SENSe<1 2>:FILTer:HPASs:FREQuency <num_value> |
| LOW PASS AF FILTER | SENSe<1 2>:FILTer[:LPASs][:STATe] ON OFF SENSe<1 2>:FILTer[:LPASs]:FREQuency <num_value> |
| WEIGHTING AF FILTER | SENSe<1 2>:FILTer:CCITt[:STATe] ON OFF SENSe<1 2>:FILTer:CMESsage[:STATe] ON OFF |
| AF COUPL'G AC DC | SENSe<1 2>:ADEMod:AF:COUPling AC DC |
| SQUELCH ON OFF | SENSe<1 2>:ADEMod:SQUelch[:STATe] ON OFF |
| SQUELCH LEVEL | SENSe<1 2>:ADEMod:SQUelch:LEVel <num_value> |
| SIDE BAND NORM INV | SENSe<1 2>:ADEMod:SBANd NORMal INVerse |
| AM/FM DEEMPH | SENSe<1 2>:FILTer:DEMPHasis:TCONstant <num_value> |
| PRE DISPL ON OFF | SENSe<1 2>:FILTer:DEMPHasis:LINK DISPlay AUDio |
| MEAS RESULT | -- |
| AM SIGNAL | :CALCulate<1 2>:FEED `XTIM:AM` |
| FM SIGNAL | :CALCulate<1 2>:FEED `XTIM:FM` |
| PM SIGNAL | :CALCulate<1 2>:FEED `XTIM:PM` |
| MODULATION SUMMARY | :CALCulate<1 2>:FEED `XTIM:AMSummary` :CALCulate<1 2>:FEED `XTIM:FMSummary` :CALCulate<1 2>:FEED `XTIM:PMSummary` :CALCulate<1 2>:MARKer<1...4>:FUNction:ADEMod:AM[:RESult?] PPEak MPEak MIDDLE RMS :CALCulate<1 2>:MARKer<1...4>:FUNction:ADEMod:FM[:RESult?] PPEak MPEak MIDDLE RMS RDEV :CALCulate<1 2>:MARKer<1...4>:FUNction:ADEMod:PM[:RESult?] PPEak MPEak MIDDLE RMS :CALCulate<1 2>:MARKer<1...4>:FUNction:ADEMod:AFREquency[:RESult?] :CALCulate<1 2>:MARKer<1...4>:FUNction:ADEMod:FERRor [:RESult?] :CALCulate<1 2>:MARKer<1...4>:FUNction:ADEMod:SINad:RESult? :CALCulate<1 2>:MARKer<1...4>:FUNction:ADEMod:CARRIER[:RESult?] |
| SUMMARY SETTINGS | -- |

| | |
|-----------------------|--|
| AVERAGE HOLD ON | SENSE<1 2>:MSUMmary:AHOLd[:STATe] ON OFF |
| SWEEP COUNT | SENSE<1 2>:SWEep:COUNT <num_value> |
| RELUNIT DB % | SENSE<1 2>:MSUMmary:RUNit PCT DB |
| INDICATION ABS REL | SENSE<1 2>:MSUMmary:MODE ABSolute RELative |
| SET REFERENCE | SENSE<1 2>:MSUMmary:REFerence <num_value> |
| MEAS-> REF | SENSE<1 2>:MSUMmary:REFerence:AUTO ONCe |
| SINAD 1kHz ON OFF | :CALCulate<1 2>:MARKer<1...4>:FUNction:ADEMod:SINad[:STATe] :CALCulate<1 2>:MARKer<1...4>:FUNction:ADEMod:SINad:RESult? |
| SUMMARY MEAS TIME | SENSE<1 2>:MSUMmary:MTIME <num_value> |
| REAL TIME ON OFF | SENSE<1 2>:ADEMod:RTIME[:STATe] ON OFF |
| SENSITIV AF OUTPUT | :OUTPut<1 2>:AF:SENSitivity <num_value> |
| VOLUME | :SYSTem:SPEaker<1 2>:VOLume <num_value> |
| DEMODO BANDWIDTH | SENSE<1 2>:BANDwidth BWIDTH:DEMod <num_value> |
| DEEMPHASIS ON OFF | SENSE<1 2>:FILTer:DEMPHasis[:STATe] ON OFF |

FREQUENCY Key Group

| | |
|---------------------|---|
| CENTER | : [SENSE<1 2>:]FREQuency:CENTer <num_value> |
| CENTER FREQUENCY | : [SENSE<1 2>:]FREQuency:CENTer <num_value> |
| FREQUENCY OFFSET | : [SENSE<1 2>:]FREQuency:OFFSet <num_value> |

LEVEL Key Group

| | |
|-------------------------|---|
| REF | -- |
| REF LEVEL | :DISPlay[:WINDow<1 2>]:TRACe<1...4>:Y[:SCALe]:RLEVel <num_value> |
| REF LEVEL OFFSET | :DISPlay[:WINDow<1 2>]:TRACe<1...4>:Y[:SCALe]:RLEVel:OFFSet <num_value> |
| RF ATTEN MANUAL | :INPut<1 2>:ATTenuation <num_value> |
| ATTEN AUTO NORMAL | :INPut<1 2>:ATTenuation:AUTO:MODE NORMAL; :INPut<1 2>:ATTenuation:AUTO ON |
| ATTEN AUTO LOW NOISE | :INPut<1 2>:ATTenuation:AUTO:MODE LNOise; :INPut<1 2>:ATTenuation:AUTO ON |
| ATTEN AUTO LOW DIST | :INPut<1 2>:ATTenuation:AUTO:MODE LDISTortion; :INPut<1 2>:ATTenuation:AUTO ON |
| MIXER LEVEL | :INPut<1 2>:MIXer <num_value> |
| RANGE | -- |
| Y PER DIV | :DISPlay[:WINDow<1 2>]:TRACe<1...4>:Y[:SCALe]:PDIVision <num_value> |
| REF VALUE Y AXIS | :DISPlay[:WINDow<1 2>]:TRACe<1...4>:Y[:SCALe]:RVALue <num_value> |
| REF VALUE X AXIS | :DISPlay[:WINDow<1 2>]:TRACe<1...4>:X[:SCALe]:RVALue <num_value> |
| REF VALUE POSITION | :DISPlay[:WINDow<1 2>]:TRACe<1...4>:Y[:SCALe]:RPOSITion 0..100PCT |
| SCALE UNIT | -- |
| Y UNIT LOG[dB] | :CALCulate<1 2>:UNIT:POWer DB |
| Y UNIT LINEAR | :CALCulate<1 2>:UNIT:POWer UNITless |
| Y UNIT DEG | :CALCulate<1 2>:UNIT:ANGLE DEG |
| Y UNIT RAD | :CALCulate<1 2>:UNIT:ANGLE RAD |
| Y UNIT DBM | :CALCulate<1 2>:UNIT:POWer DBM |
| Y UNIT VOLT | :CALCulate<1 2>:UNIT:POWer VOLT |
| Y UNIT WATT | :CALCulate<1 2>:UNIT:POWer WATT |
| X UNIT TIME | :CALCulate<1 2>:X:UNIT:TIME S |
| X UNIT SYMBOL | :CALCulate<1 2>:X:UNIT:TIME SYMB |
| SENSITIV AF OUTPUT | :OUTPut<1 2>:AF:SENSitivity <num_value> |
| VOLUME | :SYSTem:SPEaker:VOLume <num_value> |

INPUT Key

| | |
|-------------------------|---|
| INPUT | |
| RF ATTEN MANUAL | :INPut<1 2>:ATTenuation <num_value> |
| ATTEN AUTO NORMAL | :INPut<1 2>:ATTenuation:AUTO:MODE NORMAl; :INPut<1 2>:ATTenuation:AUTO ON |
| ATTEN AUTO LOW NOISE | :INPut<1 2>:ATTenuation:AUTO:MODE LNOise; :INPut<1 2>:ATTenuation:AUTO ON |
| ATTEN AUTO LOW DIST | :INPut<1 2>:ATTenuation:AUTO:MODE LDISTortion; :INPut<1 2>:ATTenuation:AUTO ON |
| MIXER LEVEL | :INPut<1 2>:MIXer <num_value> |
| ATTEN STEP 1dB 10 dB | :INPut<1 2>:ATTenuation:STEPsize 1dB 10dB (with option FSE-B13 only) |
| INPUT SELECT | -- |
| RF INPUT 50 OHM | :INPut<1 2>:IMPedance 50 |
| RF INPUT 75 OHM/RAM | :INPut<1 2>:IMPedance:CORRection RAM |
| RF INPUT 75OHM/RAZ | :INPut<1 2>:IMPedance:CORRection RAZ |

MARKER Key Group

| | |
|-----------------------------|---|
| NORMAL | |
| MARKER 1..2 | :CALCulate<1 2>:MARKer<1 2>[:STATE] ON OFF; :CALCulate<1 2>:MARKer<1 2>:X <num_value>; :CALCulate<1 2>:MARKer<1 2>:Y? |
| POLAR MARKER R/I / MA/PH | :CALCulate<1 2>:MARKer<1 2>::READout MPHase RIMaginary |
| POLAR MARKER DEG/ RAD | :CALCulate<1 2>:UNIT:ANGLE DEG RAD |
| COUPLED MARKER | :CALCulate<1 2>:MARKer<1 2>:COUPled[:STATE] ON OFF |
| MARKER INFO | DISPlay:WINDow<1 2>:MINfo ON OFF (screen display) |
| ALL MARKER OFF | :CALCulate<1 2>:MARKer<1 2>:AOFF |

| | |
|--------------------------|---|
| DELTA | |
| DELTA 1/2 | :CALCulate<1 2>:DELTaMarker<1 2>[:STATE] ON OFF :CALCulate<1 2>:DELTaMarker<1 2>:X <num_value> :CALCulate<1 2>:DELTaMarker<1 2>:Y? |
| DELTA MKR ABS / REL | :CALCulate<1 2>:DELTaMarker<1 2>:MODE ABSolute RELative |
| ALL DELTA OFF | :CALCulate<1 2>:DELTaMarker<1 2>:AOFF |
| MARKER SEARCH | |
| PEAK | :CALCulate<1 2>:MARKer<1 2>:MAXimum[:PEAK] :CALCulate<1 2>:DELTaMarker<1 2>:MAXimum[:PEAK] |
| ACTIVE MKR / DELTA | -- |
| MIN | :CALCulate<1 2>:MARKer<1 2>:MINimum[:PEAK] :CALCulate<1 2>:DELTaMarker<1 2>:MINimum[:PEAK] |
| MAX PEAK | :CALCulate<1 2>:MARKer<1 2>:MAXimum:APEak :CALCulate<1 2>:DELTaMarker<1 2>:MAXimum:APEak |
| SUMMARY ON OFF | :CALCulate<1 2>:MARKer<1 2>:FUNCTION:SUMMARY[:STATE] ON OFF |
| SUMMARY MARKER | -- |
| MAX PEAK | :CALCulate<1 2>:MARKer<1 2>:FUNCTION:SUMMARY:MAXimum[:STATE] ON OFF :CALCulate<1 2>:MARKer<1 2>:FUNCTION:SUMMARY:MAXimum:RESULT? :CALCulate<1 2>:MARKer<1 2>:FUNCTION:SUMMARY:MAXimum:AVERAGE:RESULT? :CALCulate<1 2>:MARKer<1 2>:FUNCTION:SUMMARY:MAXimum:PHOLD:RESULT? |
| +PEAK | :CALCulate<1 2>:MARKer<1 2>:FUNCTION:SUMMARY:PPEak[:STATE] ON OFF :CALCulate<1 2>:MARKer<1 2>:FUNCTION:SUMMARY:PPEak:RESULT? :CALCulate<1 2>:MARKer<1 2>:FUNCTION:SUMMARY:PPEak:AVERAGE:RESULT? :CALCulate<1 2>:MARKer<1 2>:FUNCTION:SUMMARY:PPEak:PHOLD:RESULT? |
| -PEAK | :CALCulate<1 2>:MARKer<1 2>:FUNCTION:SUMMARY:MPEak[:STATE] ON OFF :CALCulate<1 2>:MARKer<1 2>:FUNCTION:SUMMARY:MPEak:RESULT? :CALCulate<1 2>:MARKer<1 2>:FUNCTION:SUMMARY:MPEak:AVERAGE:RESULT? :CALCulate<1 2>:MARKer<1 2>:FUNCTION:SUMMARY:MPEak:PHOLD:RESULT? |
| ±PEAK/2 | :CALCulate<1 2>:MARKer<1 2>:FUNCTION:SUMMARY:MIDDLE[:STATE] ON OFF :CALCulate<1 2>:MARKer<1 2>:FUNCTION:SUMMARY:MIDDLE:RESULT? :CALCulate<1 2>:MARKer<1 2>:FUNCTION:SUMMARY:MIDDLE:AVERAGE:RESULT? :CALCulate<1 2>:MARKer<1 2>:FUNCTION:SUMMARY:MIDDLE:PHOLD:RESULT? |
| RMS | :CALCulate<1 2>:MARKer<1 2>:FUNCTION:SUMMARY:RMS[:STATE] ON OFF :CALCulate<1 2>:MARKer<1 2>:FUNCTION:SUMMARY:RMS:RESULT? :CALCulate<1 2>:MARKer<1 2>:FUNCTION:SUMMARY:RMS:AVERAGE:RESULT? :CALCulate<1 2>:MARKer<1 2>:FUNCTION:SUMMARY:RMS:PHOLD:RESULT? |
| MEAN | :CALCulate<1 2>:MARKer<1 2>:FUNCTION:SUMMARY:MEAN[:STATE] ON OFF :CALCulate<1 2>:MARKer<1 2>:FUNCTION:SUMMARY:MEAN:RESULT? :CALCulate<1 2>:MARKer<1 2>:FUNCTION:SUMMARY:MEAN:AVERAGE:RESULT? :CALCulate<1 2>:MARKer<1 2>:FUNCTION:SUMMARY:MEAN:PHOLD:RESULT? |
| PEAK HOLD ON / OFF | :CALCulate<1 2>:MARKer<1 2>:FUNCTION:SUMMARY:PHOLD ON OFF |
| AVERAGE/HOLD ON / OFF | :CALCulate<1 2>:MARKer<1 2>:FUNCTION:SUMMARY:AVERAGE ON OFF |

| | |
|------------------------|---|
| SWEEP COUNT | :[SENSe<1 2>:]SWEep:COUNT <num_value> |
| ALL SUM MKR OFF | :CALCulate<1 2>:MARKer<1 2>:FUNction:SUMMary:AOff |
| SEARCH LIMIT ON/OFF | :CALCulate<1 2>:MARKer<1 2>:X:SLIMits[:STATe] ON OFF |
| SELECT MARKER | -- |
| MKR -> | |
| PEAK | :CALCulate<1 2>:MARKer<1 2>:MAXimum[:PEAK] :CALCulate<1 2>:DELTAmarker<1 2>:MAXimum[:PEAK] |
| MKR → TRACE | :CALCulate<1 2>:MARKer<1 2>:TRACe <num_value> |
| SELECT MARKER | -- |
| ACTIVE MKR / DELTA | no corresponding IEC/IEEE-bus command |

LINES Key Group

| | |
|----------------------|--|
| D LINES | -- |
| DISPLAY LINE 1/2 | :CALCulate<1 2>:DLINe<1 2>:STATe ON OFF; :CALCulate<1 2>:DLINe<1 2> <num_value> |
| REFERENCE LINE | :CALCulate<1 2>:RLINe:STATe ON OFF; :CALCulate<1 2>:RLINe <num_value> |
| THRESHOLD LINE | :CALCulate<1 2>:THReshold ON OFF; :CALCulate<1 2>:THReshold <num_value> |
| TIME/SYMB 1/2 | :CALCulate<1 2>:TLINe<1 2>:STATe ON OFF; :CALCulate<1 2>:TLINe<1 2> <num_value> |
| LIMITS | |
| SELECT LIMIT LINE | :CALCulate<1 2>:LIMit<1...8>:NAME <string>; :CALCulate<1 2>:LIMit<1...8>:STATe ON OFF |
| NEW LIMIT LINE | see EDIT LIMIT LINE |
| NAME | :CALCulate<1 2>:LIMit<1...8>:NAME <string> |
| VALUES | no corresponding IEC/IEEE-bus command |
| INSERT VALUE | no corresponding IEC/IEEE-bus command |
| DELETE VALUE | no corresponding IEC/IEEE-bus command |

| | |
|-----------------------|--|
| SHIFT X LIMIT LINE | :CALCulate<1 2>:LIMIT<1...8>:CONTROL:SHIFT <num_value> |
| SHIFT Y LIMIT LINE | :CALCulate<1 2>:LIMIT<1...8>:UPPER:SHIFT <num_value> :CALCulate<1 2>:LIMIT<1...8>:LOWER:SHIFT <num_value> |
| SAVE LIMIT LINE | automatically executed during IEC/IEEE-bus operation |
| EDIT LIMIT LINE | :CALCulate<1 2>:LIMIT<1...8>:UNIT DB DBM RAD DEG PCT HZ S VOLT WATT UNITless :CALCulate<1 2>:LIMIT<1...8>:TRACE <num_value> :CALCulate<1 2>:LIMIT<1...8>:COMMENT 'string' :CALCulate<1 2>:LIMIT<1...8>:CONTROL[:DATA] <num_value>,<num_value>.. :CALCulate<1 2>:LIMIT<1...8>:CONTROL:DOMAIN FREQUENCY TIME :CALCulate<1 2>:LIMIT<1...8>:CONTROL:OFFSET <num_value> :CALCulate<1 2>:LIMIT<1...8>:CONTROL:MODE RELATIVE ABSOLUTE :CALCulate<1 2>:LIMIT<1...8>:CONTROL:UNIT[:TIME] S SYM :CALCulate<1 2>:LIMIT<1...8>:CONTROL:SPACING LINear LOGarithmic :CALCulate<1 2>:LIMIT<1...8>:UPPER[:DATA] <num_value>,<num_value>.. :CALCulate<1 2>:LIMIT<1...8>:UPPER:STATE ON OFF :CALCulate<1 2>:LIMIT<1...8>:UPPER:OFFSET <num_value> :CALCulate<1 2>:LIMIT<1...8>:UPPER:MARGIN <num_value> :CALCulate<1 2>:LIMIT<1...8>:UPPER:MODE RELATIVE ABSOLUTE :CALCulate<1 2>:LIMIT<1...8>:UPPER:SPACING LINear LOGarithmic :CALCulate<1 2>:LIMIT<1...8>:LOWER[:DATA] <num_value>,<num_value>.. :CALCulate<1 2>:LIMIT<1...8>:LOWER:STATE ON OFF :CALCulate<1 2>:LIMIT<1...8>:LOWER:OFFSET <num_value> :CALCulate<1 2>:LIMIT<1...8>:LOWER:MARGIN <num_value> :CALCulate<1 2>:LIMIT<1...8>:LOWER:MODE RELATIVE ABSOLUTE :CALCulate<1 2>:LIMIT<1...8>:LOWER:SPACING LINear LOGarithmic :CALCulate<1 2>:LIMIT<1...8>:FAIL? :CALCulate<1 2>:LIMIT<1...8>:CLEAR[:IMMEDIATE] |
| COPY LIMIT LINE | :CALCulate<1 2>:LIMIT<1...8>:COPY 1...8 <name> |
| DELETE LIMIT LINE | :CALCulate<1 2>:LIMIT<1...8>:DELETE |
| X OFFSET | :CALCulate<1 2>:LIMIT<1...8>:CONTROL:OFFSET <num_value> |
| Y OFFSET | :CALCulate<1 2>:LIMIT<1...8>:UPPER:OFFSET <num_value> :CALCulate<1 2>:LIMIT<1...8>:LOWER:OFFSET <num_value> |

TRACE Key Group

| | |
|---------------------|---|
| TRACE | -- |
| CLEAR/WRITE | :DISPLAY[:WINDOW<1 2>]:TRACE<1...4>:MODE WRITE |
| VIEW | :DISPLAY[:WINDOW<1 2>]:TRACE<1...4>:MODE VIEW |
| BLANK | :DISPLAY[:WINDOW<1 2>]:TRACE<1...4>[:STATE] OFF |
| CONTINUOUS WRITE | :DISPLAY[:WINDOW<1 2>]:TRACE<1...4>:MODE:CWRITE ON OFF |
| AVERAGE | :DISPLAY[:WINDOW<1 2>]:TRACE<1...4>:MODE AVERAGE or :[SENSE<1 2>:]AVERAGE:MODE SCALE |

| | |
|-------------|---|
| MAX HOLD | :DISPlay[:WINDow<1 2>]:TRACe<1...4>:MODE MAXHold or :[SENSe<1 2>]:AVERAge:MODE MAX |
| MIN HOLD | :DISPlay[:WINDow<1 2>]:TRACe<1...4>:MODE MINHold or :[SENSe<1 2>]:AVERAge:MODE MIN |
| SWEEP COUNT | :[SENSe<1 2>]:SWEep:COUNT <num_value> |

SWEEP Key Group

| | |
|-----------------------|--|
| COUPLING | -- |
| IF BW AUTO | :[SENSe<1 2>]:BANDwidth BWIDth[:RESolution]:AUTO ON OFF |
| IF BW MANUAL | :[SENSe<1 2>]:BANDwidth BWIDth[:RESolution] <num_value> |
| MAIN PLL BANDWIDTH | :[SENSe<1 2>]:BANDwidth BWIDth:PLL AUTO HIGH MEDIum LOW |
| SWEEP | |
| CONTINUOUS SWEEP | :INITiate<1 2>:CONTinuous ON; :INITiate<1 2>[:IMMediate] |
| SINGLE SWEEP | :INITiate<1 2>:CONTinuous OFF; :INITiate<1 2>[:IMMediate] |
| SWEEP COUNT | :[SENSe<1 2>]:SWEep:COUNT <num_value> |
| SWEEP TIME | :[SENSe<1 2>]:SWEep:TIME <num_value> (analog demodulation only) |
| RESULT LENGTH | :[SENSe<1 2>]:DDEMod:TIME <num_value> (digital demodulation only) |

TRIGGER Key Group - Digital Demodulation

| | |
|-------------------|---|
| TRIGGER | |
| FREE RUN | :TRIGger<1 2>[:SEquence]:SOURce IMMEDIATE |
| VIDEO | :TRIGger<1 2>[:SEquence]:SOURce VIDEo :TRIGger<1 2>[:SEquence]:LEVel:VIDEo <num_value> |
| EXTERN | :TRIGger<1 2>[:SEquence]:SOURce EXTErnal :TRIGger<1 2>[:SEquence]:LEVel:EXTErnal <num_value> |
| TRIGGER OFFSET | :TRIGger<1 2>[:SEquence]:HOLDoff <num_value> |

| | |
|------------------------|---|
| SLOPE POS NEG | :TRIGger<1 2>[:SEquence]:SLOPe POSitive NEGative |
| MEAS ONLY IF SYNC'D | :[SENSe<1 2>:]DDEMod:SEARch:SYNC:MONLy ON OFF |
| FIND BURST ON OFF | :[SENSe<1 2>:]DDEMod:SEARch:PULSe:STATe ON OFF |
| FIND SYNC ON OFF | :[SENSe<1 2>:]DDEMod:SEARch:SYNC:STATe ON OFF |
| SYNC OFFSET | :[SENSe<1 2>:]DDEMod:SEARch:SYNC:OFFSet <num_value> |
| SYNC PATTERN | -- |
| SELECT PATTERN | :[SENSe<1 2>:]DDEMod:SEARch:SYNC:SElect <pattern_name> |
| NEW SYNC PATTERN | :[SENSe<1 2>:]DDEMod:SEARch:SYNC:PATtern <string> |
| NAME | :[SENSe<1 2>:]DDEMod:SEARch:SYNC:NAME <pattern_name> |
| COMMENT | :[SENSe<1 2>:]DDEMod:SEARch:SYNC:COMment <string> |
| VALUE | :[SENSe<1 2>:]DDEMod:SEARch:SYNC:DATA <string> :[SENSe<1 2>:]DDEMod:SEARch:SYNC:PATtern <string> (the pattern is set in the instrument and automatically saved under the name remote.pat) |
| SAVE PATTERN | automatically executed during IEC/IEEE-bus operation (see command :[SENSe<1 2>:]DDEMod:SEARch:SYNC:PATtern <string>) |
| EDIT SYNC PATTERN | :[SENSe<1 2>:]DDEMod:SEARch:SYNC:PATtern <string> |
| DELETE PATTERN | :[SENSe<1 2>:]DDEMod:SEARch:SYNC:DELete |

TRIGGER Key Group - Analog Demodulation

| | |
|-------------------|--|
| TRIGGER | |
| FREE RUN | :TRIGger<1 2>[:SEquence]:SOURce IMMEDIATE |
| VIDEO | :TRIGger<1 2>[:SEquence]:SOURce VIDEo :TRIGger<1 2>[:SEquence]:LEVel:VIDEo <num_value> |
| EXTERN | :TRIGger<1 2>[:SEquence]:SOURce EXternal :TRIGger<1 2>[:SEquence]:LEVel[:EXternal] -5.0...+5.0V |
| AF SIGNAL | :TRIGger<1 2>[:SEquence]:SOURce AF :TRIGger<1 2>[:SEquence]:LEVel:AF -120...+120PCT |
| SLOPE POS/NEG | :TRIGger<1 2>[:SEquence]:SLOPe POSitive NEGative |
| TRIGGER OFFSET | :TRIGger<1 2>[:SEquence]:HOLDoff <num_value> |

Operating Mode Tracking Generator (Option FSE-B8 to B11)

CONFIGURATION Key Group

| | |
|-------------------------|---|
| MODE | |
| TRACKING GEN | -- |
| SOURCE ON/OFF | :OUTPut<1 2>[:STATe] ON OFF |
| SOURCE POWER | SOURce:POWer[:LEVel][:IMMediate][:AMPLitude] <num_value> |
| POWER OFFSET | SOURce:POWer[:LEVel][:IMMediate]:OFFSet <num_value> |
| SOURCE CAL | -- |
| CAL TRANS | :[SENSe<1 2>:]CORRection:METhod TRANsmission :[SENSe<1 2>:]CORRection:COLLect[:ACQuire] THRUgh |
| CAL REFL SHORT | :[SENSe<1 2>:]CORRection:METhod REFLeXion :[SENSe<1 2>:]CORRection:COLLect[:ACQuire] THRUgh |
| CAL REFL OPEN | :[SENSe<1 2>:]CORRection:METhod REFLeXion :[SENSe<1 2>:]CORRection:COLLect[:ACQuire] OPEN |
| NORMALIZE | :[SENSe<1 2>:]CORRection[:STATe] ON OFF |
| REF VALUE POSITION | :DISPlay[:WINDow<1 2>]:TRACe<1...4>:Y[:SCALe]:RPOSITion 0...100PCT |
| REF VALUE | :DISPlay[:WINDow<1 2>]:TRACe<1...4>:Y[:SCALe]:RVALue <num_value> |
| RECALL | :[SENSe<1 2>:]CORRection:RECall |
| FREQUENCY OFFSET | SOURce:FREQuency:OFFSet <num_value> |
| MODULATION | -- |
| EXT AM | SOURce:AM:STATe ON OFF |
| EXT ALC | SOURce:POWer:ALC:SOURce INTernal EXTernal |
| EXT FM | SOURce:FM:STATe ON OFF |
| EXT I/Q | SOURce:DM:STATe ON OFF |

Operating Mode TV Demodulation (Option FSE-B3)

CONFIGURATION Key Group

| | |
|-----------------------|---|
| MODE | |
| TV DEMOD | : [SENSe<1 2>:]TV[:STATE] ON OFF |
| VIDEO POL NEGATIVE | : TRIGger<1 2>[:SEQuence]:VIDeo:SSIGnal:POLarity NEGative |
| VIDEO POL POSITIVE | : TRIGger<1 2>[:SEQuence]:VIDeo:SSIGnal:POLarity POSitive |
| 625 LINE SYSTEM | : TRIGger<1 2>[:SEQuence]:VIDeo:FORMat:LPFRame 625 |
| 525 LINE SYSTEM | : TRIGger<1 2>[:SEQuence]:VIDeo:FORMat:LPFRame 525 |
| PICT/SOUND OFFSET | : [SENSe<1 2>:]TV:PSOFFset <num_value> |
| TV DEMOD OFF | : [SENSe<1 2>:]TV[:STATE] ON OFF |

SWEEP Key Group

| | |
|-------------------------|---|
| TRIGGER | |
| TV | : TRIGger<1 2>[:SEQuence]:SOURce TV |
| TV TRIGGER SETTINGS | -- |
| VERT SYNC | : TRIGger<1 2>[:SEQuence]:VIDeo:FIELD:SElect ALL |
| HOR SYNC | : TRIGger<1 2>[:SEQuence]:VIDeo:LINE:NUMBer <num_value> |
| VERT SYNC EVEN FIELD | : TRIGger<1 2>[:SEQuence]:VIDeo:FIELD:SElect EVEN |
| VERT SYNC ODD FIELD | : TRIGger<1 2>[:SEQuence]:VIDeo:FIELD:SElect ODD |

Operating Mode GSM BTS Analyzer (Option FSE-K11)

CONFIGURATION Key Group

| | |
|-----------------------|---|
| MODE | |
| GSM BTS ANALYZER | ::INSTRument<1 2>[:SElect] BGSM |
| SETTINGS | -- |
| EXTERNAL ATTEN | :[SENSe<1 2>:]CORRection:LOSS:INPut[:MAGNitude] <num_value> |
| ARFCN / FREQUENCY | -- |
| ARFCN | CONFIgure[:BTS]:ARFCn <num_value> |
| ARFCN AUTOSELECT | CONFIgure[:BTS]:ARFCn:AUTO ONCE |
| FREQUENCY | SENSe<1 2>:FREQuency:CENTer <num_value> |
| POWER SETTINGS | -- |
| EXTERNAL ATTEN | SENSe<1 2>:CORRection:LOSS:INPut[:MAGNitude] <num_value> |
| NOMINAL OUTPUT PWR | CONFIgure[:BTS]:POWer:EXPEcted <num_value> |
| POWER CLASS | CONFIgure[:BTS]:POWer:CLASs <num_value> M1 M2 M3 P1 |
| STATIC PWR CTRL LEVEL | CONFIgure[:BTS]:POWer:STATic <num_value> |
| DYNAM PWR CTRL LEVEL | CONFIgure[:BTS]:POWer:DYNamic <num_value> |
| STATION TYPE | CONFIgure[:BTS]:STYPe NORMAl MICRo PICO |
| LIMIT/PWR COUPLED | CONFIgure[:BTS]:POWer:COUPled ON OFF |
| SIGNAL POWER | CONFIgure[:BTS]:POWer:EXPEcted <num_value> |
| LIMIT LINE REF POWER | CONFIgure[:BTS]:POWer:LIMit <num_value> |
| LIMIT MARGIN | :CALCulate<1 2>:LIMit<1...8>:MARGin <num_value> |
| SLOT NO. | -- |
| SLOT NO. | CONFIgure[:BTS]:CHANnel:SLOT 0...7 |

| | |
|-------------------------|--|
| SLOT NO. AUTOSELECT | CONFigure[:BTS]:CHANnel:SLOT:AUTO ONCE |
| MIDAMBLE | CONFigure[:BTS]:CHANnel:TSC 0...7 CONFigure[:BTS]:CHANnel:TSC:AUTO ON OFF |
| TRIGGER | -- |
| FREE RUN | :TRIGger<1 2>[:SEquence]:SOURce IMMEDIATE |
| EXTERN | :TRIGger<1 2>[:SEquence]:SOURce EXTERNAL :TRIGger<1 2>[:SEquence]:LEVel[:EXTernal] -5.0...+5.0V |
| SLOPE POS NEG | :TRIGger<1 2>[:SEquence]:SLOPe POSitive NEGative |
| TRIGGER ADJUST | -- |
| FRAME COARSE | :TRIGger<1 2>[:SEquence]:SYNChronize:ADJust:FRAME <num_value> |
| FRAME FINE | :TRIGger<1 2>[:SEquence]:SYNChronize:ADJust:FRAME <num_value> |
| AUTO FRAME ADJUST | :TRIGger<1 2>[:SEquence]:SYNChronize:ADJust:FRAME:AUTO ONCE |
| SLOT ADJUST | :TRIGger<1 2>[:SEquence]:SYNChronize:ADJust:SLOT <num_value> |
| AUTO SLOT ADJUST | :TRIGger<1 2>[:SEquence]:SYNChronize:ADJust:SLOT:AUTO ONCE |
| TRIGGER LEVEL | :TRIGger<1 2>[:SEquence]:LEVel[:EXTernal] <num_value> |
| SLOPE POS NEG | :TRIGger<1 2>[:SEquence]:SLOPe POSitive NEGative |
| DEFAULT SETTINGS | CONFigure[:BTS]:PRESet |
| P-GSM 900 | CONFigure[:BTS]:NETWork[:TYPE] PGSM PGSM900 |
| GSM 1800 (DCS 1800) | CONFigure[:BTS]:NETWork[:TYPE] DCS GSM1800 |
| GSM 1900 (PCS 1900) | CONFigure[:BTS]:NETWork[:TYPE] PCS GSM1900 |
| R-GSM 900 | CONFigure[:BTS]:NETWork[:TYPE] RGSM RGSM900 |
| GSM 850 | CONFigure[:BTS]:NETWork[:TYPE] GSM850 |
| PHASE I | CONFigure[:BTS]:NETWork:PHASe 1 |
| PHASE II | CONFigure[:BTS]:NETWork:PHASe 2 |
| PHASE II+ | CONFigure[:BTS]:NETWork:PHASe 2,PLUS |
| MODULATION GMSK EDGE | :CONFigure<1 2>[:MS]:MTYPE GMSK EDGE with option FSE-K20 only |

| | |
|-------------------------|--|
| PHASE/FREQ ERROR | CONFigure:BURSt:PFERror[:IMMediate] |
| SINGLE | :INITiate<1 2>:CONTinuous OFF; :INITiate<1 2>[:IMMediate] :READ:BURSt:PERRor:RMS:STATus? :READ:BURSt:PERRor:RMS:AVErAge? :READ:BURSt:PERRor:RMS:MAXimum? :READ:BURSt:PERRor:PEAK:STATus? :READ:BURSt:PERRor:PEAK:AVErAge? :READ:BURSt:PERRor:PEAK:MAXimum? :READ:BURSt:FERRor:STATus? :READ:BURSt:FERRor:AVErAge? :READ:BURSt:FERRor:MAXimum? |
| CONTINUOUS | :INITiate<1 2>:CONTinuous ON; :INITiate<1 2>[:IMMediate] :FETCh:BURSt:PERRor:RMS:STATus? :FETCh:BURSt:PERRor:RMS:AVErAge? :FETCh:BURSt:PERRor:RMS:MAXimum? :FETCh:BURSt:PERRor:PEAK:STATus? :FETCh:BURSt:PERRor:PEAK:AVErAge? :FETCh:BURSt:PERRor:PEAK:MAXimum? :FETCh:BURSt:FERRor:STATus? :FETCh:BURSt:FERRor:AVErAge? :FETCh:BURSt:FERRor:MAXimum? |
| NO. OF BURSTS | -- |
| SET MANUAL | :CONFigure<1 2>:BURSt:PFERror:COUNT <num_value> |
| SET TO STANDARD | -- |
| ARFCN / FREQUENCY | see submenu SETTINGS |
| POWER SETTINGS | see submenu SETTINGS |
| X UNIT SYMB TIME | :CALCulate<1 2>:X:UNIT:TIME S SYM |
| CONDITIONS NORM EXTR | :CONFigure<1 2>:BURSt:PFERror:CONDitions NORMal EXTReMe |
| TRIGGER | see submenu SETTINGS |
| EDIT | -- |
| PHASE PEAK | :CONFigure<1 2>[:BTS]:LIMit:PPEak <num_value> |
| PHASE RMS | :CONFigure<1 2>[:BTS]:LIMit:PRMS <num_value> |
| FREQUENCY | :CONFigure<1 2>[:BTS]:LIMit:FREQuency <num_value> |
| USER LIMIT ON OFF | :CONFigure<1 2>[:BTS]:LIMit:STANDard ON OFF |
| MODULATION ACCURACY | :CONFigure<1 2>:BURSt:MACCuracy[:IMMediate] with option FSE-K21 only |

| | |
|----------------------|---|
| SINGLE | :INITiate<1 2>:CONTinuous OFF; :INITiate<1 2>[:IMMediate] :READ:BURSt:MACCuracy:RMS:STATUs :READ:BURSt:MACCuracy:RMS:AVERAge :READ:BURSt:MACCuracy:RMS:MAXimum :READ:BURSt:MACCuracy:PEAK:STATUs :READ:BURSt:MACCuracy:PEAK:AVERAge :READ:BURSt:MACCuracy:PEAK:MAXimum :READ:BURSt:MACCuracy:OSUPpress:STATUs :READ:BURSt:MACCuracy:OSUPpress:AVERAge :READ:BURSt:MACCuracy:OSUPpress:MAXimum :READ:BURSt:MACCuracy:PERCentile:STATUs :READ:BURSt:MACCuracy:PERCentile:AVERAge :READ:BURSt:MACCuracy:PERCentile:MAXimum :READ:BURSt:MACCuracy:FREQuency:STATUs :READ:BURSt:MACCuracy:FREQuency:AVERAge :READ:BURSt:MACCuracy:FREQuency:MAXimum |
| CONTINUOUS | :INITiate<1 2>:CONTinuous ON; :INITiate<1 2>[:IMMediate] :FETCh:BURSt:MACCuracy:RMS:STATUs :FETCh:BURSt:MACCuracy:RMS:AVERAge :FETCh:BURSt:MACCuracy:RMS:MAXimum :FETCh:BURSt:MACCuracy:PEAK:STATUs :FETCh:BURSt:MACCuracy:PEAK:AVERAge :FETCh:BURSt:MACCuracy:PEAK:MAXimum :FETCh:BURSt:MACCuracy:OSUPpress:STATUs :FETCh:BURSt:MACCuracy:OSUPpress:AVERAge :FETCh:BURSt:MACCuracy:OSUPpress:MAXimum :FETCh:BURSt:MACCuracy:PERCentile:STATUs :FETCh:BURSt:MACCuracy:PERCentile:AVERAge :FETCh:BURSt:MACCuracy:PERCentile:MAXimum :FETCh:BURSt:MACCuracy:FREQuency:STATUs :FETCh:BURSt:MACCuracy:FREQuency:AVERAge :FETCh:BURSt:MACCuracy:FREQuency:MAXimum |
| NO. OF BURSTS | |
| SET MANUAL | :CONFigure<1 2>:BURSt:MACCuracy:COUNT <num_value> |
| SET TO STANDARD | -- |
| ARFCN / FREQUENCY | See submenu SETTINGS |
| POWER SETTINGS | See submenu SETTINGS |
| X UNIT SYMB TIME | :CALCulate<1 2>::X:UNIT:TIME S SYM |
| CONDITIONS NORM EXTR | :CONFigure<1 2>:BURSt:MACCuracy:CONDitions NORMal EXTReMe |
| TRIGGER | See submenu SETTINGS |
| EDIT | -- |
| RMS EVM | :CONFigure<1 2>[:BTS]:LIMit:EVMRms <num_value> |
| PEAK EVM | :CONFigure<1 2>[:BTS]:LIMit:EVMPeak <num_value> |
| ORIG OFFS SUPPRESS | :CONFigure<1 2>[:BTS]:LIMit:OSUPpress <num_value> |
| 95% PERCENTILE | :CONFigure<1 2>[:BTS]:LIMit:PERCentile <num_value> |

| | |
|--------------------------|---|
| FREQUENCY | :CONFigure<1 2>[:BTS]:LIMit:FREQuency <num_value> |
| USER LIMIT ON OFF | :CONFigure<1 2>[:BTS]:LIMit:STANdard ON OFF |
| CARRIER POWER | :CONFigure<1 2>:BURSt:POWer[:IMMediate] :CALCulate<1 2>:LIMit:BURSt:POWer? |
| MEAS MAX OUTPUT PWR | :READ:BURSt:POWer? |
| INC STATIC PWR CTRL | :READ:BURSt:POWer:STATic? |
| INC DYNAM PWR CTRL | :READ:BURSt:POWer:DYNAmic? |
| NO. OF BURSTS | -- |
| SET MANUAL | :CONFigure<1 2>:BURSt:POWer:COUNT <num_value> |
| SET TO STANDARD | -- |
| SGL MEAS ON OFF | :CONFigure<1 2>[:BTS]:POWer:SINGle[:STATe] ON OFF |
| MEAS SGL PWR LEVEL | :READ:BURSt:POWer? |
| STATIC PWR CTRL LEVEL | :CONFigure<1 2>[:BTS]:POWer:STATic <num_value> |
| DYNAM PWR CTRL LEVEL | :CONFigure<1 2>[:BTS]:POWer:DYNAmic <num_value> |
| CLEAR SGL RESULT TAB | :CONFigure<1 2>[:BTS]:POWer:SINGle:CLEAr |
| SIGNAL POWER | :CONFigure<1 2>[:BTS]:POWer:EXPEcted <num_value> |
| ARFCN / FREQUENCY | see submenu SETTINGS |
| POWER SETTINGS | see submenu SETTINGS |
| CONDITIONS NORM EXTR | :CONFigure<1 2>:BURSt:POWer:CONDition NORMAl EXTREme |
| MEAS BANDWIDTH | :[SENSe<1 2>:]BANDwidth BWiDth[:RESolution] DEF 300kHz 1MHz |
| SYNC TO MIDAMBLE | :TRIGger<1 2>[:SEQuence]:SYNChronize:SOURce FRAME TSC |
| TRIGGER | see submenu SETTINGS |
| POWER VS TIME | :CONFigure<1 2>:BURSt:PTEMplate[:IMMediate] :CALCulate<1 2>:LIMit:BURSt:PTEMplate? |
| SINGLE | :INITiate<1 2>:CONTinuous OFF; :INITiate<1 2>[:IMMediate] |

| | |
|-----------------------|---|
| CONTINUOUS | :INITiate<1 2>:CONTinuous ON; :INITiate<1 2>[:IMMediate] |
| BURST HIGH RESOLUTION | :CONFIgure<1 2>:BURSt:PTEMplate:SELEct TOP |
| NO. OF BURSTS | -- |
| SET MANUAL | :CONFIgure<1 2>:BURSt:PTEMplate:COUNT <num_value> |
| SET TO STANDARD | -- |
| FULL BURST | :CONFIgure<1 2>:BURSt:PTEMplate:SELEct FULL |
| RISING EDGE | :CONFIgure<1 2>:BURSt:PTEMplate:SELEct RISing |
| FALLING EDGE | :CONFIgure<1 2>:BURSt:PTEMplate:SELEct FALLing |
| START REF MEAS | :READ:BURSt:REFerence[:IMMediate]? |
| REF MEAS AUTO USER | :CONFIgure<1 2>:BURSt:REFerence:AUTO ON OFF |
| ARFCN / FREQUENCY | see submenu SETTINGS |
| POWER SETTINGS | see submenu SETTINGS |
| X UNIT SYMB TIME | CALCulate:X:UNIT:TIME S SYM |
| MEAS BANDWIDTH | :[SENSE<1 2>:]BANDwidth BWIDth[:RESolution] DEF 300 kHz 1 MHz |
| SYNC TO MIDAMBLE | :TRIGger<1 2>[:SEQuence]:SYNChronize:SOURce FRAMe TSC |
| TRIGGER | see submenu SETTINGS |
| EDIT | -- |
| LIMIT LINE FILTER | -- |
| NEW LIMIT LINE | see basic instrument |
| EDIT LIMIT LINE | see basic instrument |
| COPY LIMIT LINE | see basic instrument |
| DELETE LIMIT LINE | see basic instrument |
| USER LIMIT ON OFF | :CONFIgure<1 2>[:BTS]:LIMit:STANDard ON OFF |
| PAGE UP | -- |

| | |
|-----------------------|---|
| PAGE DOWN | -- |
| MODULATION SPECTRUM | :CONFIgure<1 2>:SPECTrum:MODulation[:IMMediate] :CALCulate<1 2>:LIMit:SPECTrum:MODulation? ARFCn TXBand RXBand COMBined :CALCulate<1 2>:LIMit:SPECTrum:MODulation:FAILs? ARFCn TXBand RXBand COMBined :CALCulate<1 2>:LIMit:SPECTrum:MODulation:EXCeptions? ARFCn TXBand RXBand COMBined |
| SINGLE FREQ SWEEP | :INITiate<1 2>:CONTInuous OFF; :INITiate<1 2>[:IMMediate] |
| CONTINUOUS FREQ SWEEP | :INITiate<1 2>:CONTInuous ON; :INITiate<1 2>[:IMMediate] |
| START LIST | :READ:SPECTrum:MODulation[:ALL]? |
| NO. OF BURSTS | -- |
| SET MANUAL | :CONFIgure<1 2>:SPECTrum:MODulation:COUNT <num_value> |
| SET TO STANDARD | -- |
| ARFCN ±1.8 MHZ | :CONFIgure<1 2>:SPECTrum:MODulation:RANGE ARFCn |
| TX BAND | :CONFIgure<1 2>:SPECTrum:MODulation:RANGE TXBand |
| ±1.8 MHZ / TX BAND | :CONFIgure<1 2>:SPECTrum:MODulation:RANGE COMBined |
| RX BAND | :CONFIgure<1 2>:SPECTrum:MODulation:RANGE RXBand |
| ARFCN / FREQUENCY | see submenu SETTINGS |
| POWER SETTINGS | see submenu SETTINGS |
| RX BAND GAIN | :[SENSe<1 2>:]CORRection:RXGain:INPut[:MAGNitude] <num_value> |
| TX GATE ON OFF | :CONFIgure<1 2>:SPECTrum:MODulation:TGATE ON OFF |
| TRIGGER | see submenu SETTINGS |
| EDIT | -- |
| LIMIT LINE FILTER | -- |
| NEW LIMIT LINE | see basic instrument |
| EDIT LIMIT LINE | see basic instrument |
| COPY LIMIT LINE | see basic instrument |
| DELETE LIMIT LINE | see basic instrument |

| | |
|--------------------------|--|
| USER LIMIT ON OFF | :CONFIgure<1 2>[:BTS]:LIMit:STANdard ON OFF |
| PAGE UP | -- |
| PAGE DOWN | -- |
| TRANSIENT SPECTRUM | :CONFIgure<1 2>:SPECTrum:SWITChing[:IMMediate] :CALCulate<1 2>:LIMit:SPECTrum:SWITChing? :CALCulate<1 2>:LIMit:SPECTrum:SWITChing:FAILs? |
| SINGLE FREQ SWEEP | :INITiate<1 2>:CONTinuous OFF; :INITiate<1 2>[:IMMediate] |
| CONTINUOUS FREQ SWEEP | :INITiate<1 2>:CONTinuous ON; :INITiate<1 2>[:IMMediate] |
| START LIST | :READ:SPECTrum:SWITChing[:ALL]? |
| NO. OF BURSTS | -- |
| SET MANUAL | :CONFIgure<1 2>:SPECTrum:SWITChing:COUNT <num_value> |
| SET TO STANDARD | -- |
| ARFCN / FREQUENCY | see submenu SETTINGS |
| POWER SETTINGS | see submenu SETTINGS |
| BTS SFH ON OFF | :CONFIgure<1 2>[:BTS]:CHANnel:SFH ON OFF |
| MEAS BANDWIDTH | :[SENSe<1 2>:]BANDwidth BWIDth[:RESolution] DEF 300kHz 1MHz |
| TRIGGER | see submenu SETTINGS |
| EDIT | -- |
| LIMIT LINE FILTER | -- |
| NEW LIMIT LINE | see basic instrument |
| EDIT LIMIT LINE | see basic instrument |
| COPY LIMIT LINE | see basic instrument |
| DELETE LIMIT LINE | see basic instrument |
| USER LIMIT ON OFF | :CONFIgure<1 2>[:BTS]:LIMit:STANdard ON OFF |
| PAGE UP | -- |
| PAGE DOWN | -- |

| | |
|-------------------------|--|
| SPURIOUS | :CONFigure<1 2>:SPURious[:IMMediate] :CALCulate<1 2>:LIMit:SPURious? TXBand OTXBand RXBand :CALCulate<1 2>:LIMit:SPURious:FAILs? TXBand OTXBand RXBand |
| START LIST SGL STEP | ABORT;:READ:SPURious:STEP? |
| CONT LIST SGL STEP | :READ:SPURious:STEP? |
| START LIST | :READ:SPURious [:ALL]? |
| SWEEP COUNT | -- |
| SWP COUNT TX / <> TX | :CONFigure<1 2>:SPURious:COUNT <num_value> |
| SWP COUNT RX BAND | :CONFigure<1 2>:SPURious:COUNT:RXBand <num_value> |
| SET TO STANDARD | -- |
| TX BAND | :CONFigure<1 2>:SPURious:RANGe TXBand |
| <> TX BAND | :CONFigure<1 2>:SPURious:RANGe OTXBand |
| RX BAND | :CONFigure<1 2>:SPURious:RANGe RXBand |
| TX BAND ±2.MHZ | :CONFigure<1 2>:SPURious:RANGe COMBined |
| SELECT STEP | :CONFigure<1 2>:SPURious:STEP:COUNT? :CONFigure<1 2>:SPURious:STEP<1..26> ON OFF |
| ARFCN / FREQUENCY | see submenu SETTINGS |
| POWER SETTINGS | see submenu SETTINGS |
| BTS SFH ON OFF | :CONFigure<1 2>[:BTS]:CHANnel:SFH ON OFF |
| TX SUPPR ON OFF | :CONFigure<1 2>[:BTS]:TXSupp ON OFF |
| RX BAND GAIN | :[SENSe<1 2>:]CORRection:RXGain:INPut[:MAGNitude] <num_value> |
| COSITING | :CONFigure<1 2>[:BTS]:COSiting ON OFF |
| SWEPTIME STD AUTO | :CONFigure<1 2>[:BTS]:SWEeptime STANDard AUTO |
| TRIGGER | see submenu SETTINGS |
| EDIT | -- |
| LIMIT LINE FILTER | -- |

| | |
|----------------------|---|
| NEW LIMIT LINE | see basic instrument |
| EDIT LIMIT LINE | see basic instrument (Einheiten DB DBM) |
| COPY LIMIT LINE | see basic instrument |
| DELETE LIMIT LINE | see basic instrument |
| USER LIMIT ON OFF | :CONFigure<1 2>[:BTS]:LIMit:STANdard ON OFF |
| PAGE UP | -- |
| PAGE DOWN | -- |

Operating Mode GSM MS Analyzer (Option FSE-K10)

CONFIGURATION Key Group

| | |
|----------------------|---|
| MODE | |
| GSM MS ANALYZER | ::INSTRument<1 2>[:SElect] MGSM |
| SETTINGS | -- |
| EXTERNAL ATTEN | :[SENSe<1 2>:]CORRection:LOSS:INPut[:MAGNitude] <num_value> |
| ARFCN / FREQUENCY | -- |
| ARFCN | :CONFigure<1 2>[:MS]:ARFCn <num_value> |
| ARFCN AUTOSELECT | :CONFigure<1 2>[:MS]:ARFCn:AUTO ONCE |
| FREQUENCY | :[SENSe<1 2>:]FREQUency:CENTer <num_value> |
| POWER SETTINGS | -- |
| EXTERNAL ATTEN | :[SENSe<1 2>:]CORRection:LOSS:INPut[:MAGNitude] <num_value> |
| OUTPUT MS POWER | :CONFigure<1 2>[:MS]:POWer:EXPEcted <num_value> EG1 EG2 EG3 EG1, EG1, EG3 only for EDGE (option K20) |
| POWER CLASS | :CONFigure<1 2>[:MS]:POWer:CLASs <num_value> |
| POWER CTRL LEVEL | :CONFigure<1 2>[:MS]:POWer:LEVel <num_value> |
| SMALL MS ON OFF | :CONFigure<1 2>[:MS]:POWer:SMALl ON OFF |
| SMALL MS ON OFF | :CONFigure<1 2>[:MS]:POWer:SMALl ON OFF |
| LIMIT/PWR COUPLED | :CONFigure<1 2>[:MS]:POWer:COUPled ON OFF |
| SIGNAL POWER | :CONFigure<1 2>[:MS]:POWer:EXPEcted <num_value> |
| LIMIT LINE REF POWER | :CONFigure<1 2>[:MS]:POWer:LIMit <num_value> |
| LIMIT MARGIN | :CALCulate<1 2>:LIMit:MARGin <num_value> |
| MIDAMBLE | :CONFigure<1 2>[:MS]:CHANnel:TSC 0...7 |

| | |
|------------------------|--|
| TRIGGER | -- |
| FREE RUN | :TRIGger<1 2>[:SEquence]:SOURce IMMEDIATE |
| VIDEO | :TRIGger<1 2>[:SEquence]:SOURce VIDEO |
| EXTERN | :TRIGger<1 2>[:SEquence]:SOURce EXTERNAL :TRIGger<1 2>[:SEquence]:LEVel[:EXTernal] -5.0...+5.0V |
| RF POWER | :TRIGger<1 2>[:SEquence]:SOURce RFPower |
| SLOPE POS NEG | :TRIGger<1 2>[:SEquence]:SLOPe POSitive NEGative |
| TRIGGER ADJUST | -- |
| COARSE ADJUST | :TRIGger<1 2>[:SEquence]:SYNChronize:ADJust:SLOT <num_value> |
| FINE ADJUST | :TRIGger<1 2>[:SEquence]:SYNChronize:ADJust:SLOT <num_value> |
| AUTO ADJUST | :TRIGger<1 2>[:SEquence]:SYNChronize:ADJust:SLOT:AUTO ONCE |
| TRIGGER LEVEL | :TRIGger<1 2>[:SEquence]:LEVel[:EXTernal] <num_value> |
| SLOPE POS NEG | :TRIGger<1 2>[:SEquence]:SLOPe POSitive NEGative |
| DEFAULT SETTINGS | :CONFigure<1 2>[:MS]:PRESet |
| P-GSM 900 | :CONFigure<1 2>[:MS]:NETWork[:TYPE] PGSM PGSM900 |
| E-GSM 900 | :CONFigure<1 2>[:MS]:NETWork[:TYPE] EGSM EGSM900 |
| GSM 1800 (DCS 1800) | :CONFigure<1 2>[:MS]:NETWork[:TYPE] DCS GSM1800 |
| GSM 1900 (PCS 1900) | :CONFigure<1 2>[:MS]:NETWork[:TYPE] PCS GSM1900 |
| R-GSM 900 | :CONFigure<1 2>[:MS]:NETWork[:TYPE] RGSM RGSM900 |
| GSM 850 | :CONFigure<1 2>[:MS]:NETWork[:TYPE] GSM850 |
| PHASE I | :CONFigure<1 2>[:MS]:NETWork:PHASE 1 |
| PHASE II | :CONFigure<1 2>[:MS]:NETWork:PHASE 2 |
| PHASE II+ | :CONFigure<1 2>[:MS]:NETWork:PHASE 2,PLUS |

| | |
|-------------------------|---|
| MODULATION GMSK EDGE | :CONFigure<1 2>[:MS]:MType GMSK EDGE with option FSE-K20 only |
| PHASE/FREQ ERROR | :CONFigure<1 2>:BURSt:PFERror[:IMMediate] |
| SINGLE | :INITiate<1 2>:CONTinuous OFF; :INITiate<1 2>[:IMMediate] |
| CONTINUOUS | :INITiate<1 2>:CONTinuous ON; :INITiate<1 2>[:IMMediate] |
| NO. OF BURSTS | |
| SET MANUAL | :CONFigure<1 2>:BURSt:PFERror:COUNT <num_value> |
| SET TO STANDARD | -- |
| ARFCN / FREQUENCY | see submenu SETTINGS |
| POWER SETTINGS | see submenu SETTINGS |
| X UNIT SYMB TIME | :CALCulate<1 2>::X:UNIT:TIME S SYM |
| CONDITIONS NORM EXTR | :CONFigure<1 2>:BURSt:PFERror:CONDitions NORMal EXTReMe |
| TRIGGER | see submenu SETTINGS |
| EDIT | -- |
| PHASE PEAK | :CONFigure<1 2>[:MS]:LIMit:PPEak <num_value> |
| PHASE RMS | :CONFigure<1 2>[:MS]:LIMit:PRMS <num_value> |
| FREQUENCY | :CONFigure<1 2>[:MS]:LIMit:FREQuency <num_value> |
| USER LIMIT ON OFF | :CONFigure<1 2>[:MS]:LIMit:STANdard ON OFF |
| MODULATION ACCURACY | :CONFigure<1 2>:BURSt:MACCuracy[:IMMediate] with option FSE-K20 only |

| | |
|----------------------|---|
| SINGLE | :INITiate<1 2>:CONTinuous OFF; :INITiate<1 2>[:IMMediate] :READ:BURSt:MACCuracy:RMS:STATUs :READ:BURSt:MACCuracy:RMS:AVERAge :READ:BURSt:MACCuracy:RMS:MAXimum :READ:BURSt:MACCuracy:PEAK:STATUs :READ:BURSt:MACCuracy:PEAK:AVERAge :READ:BURSt:MACCuracy:PEAK:MAXimum :READ:BURSt:MACCuracy:OSUPpress:STATUs :READ:BURSt:MACCuracy:OSUPpress:AVERAge :READ:BURSt:MACCuracy:OSUPpress:MAXimum :READ:BURSt:MACCuracy:PERCentile:STATUs :READ:BURSt:MACCuracy:PERCentile:AVERAge :READ:BURSt:MACCuracy:PERCentile:MAXimum :READ:BURSt:MACCuracy:FREQuency:STATUs :READ:BURSt:MACCuracy:FREQuency:AVERAge :READ:BURSt:MACCuracy:FREQuency:MAXimum |
| CONTINUOUS | :INITiate<1 2>:CONTinuous ON; :INITiate<1 2>[:IMMediate] :FETCh:BURSt:MACCuracy:RMS:STATUs :FETCh:BURSt:MACCuracy:RMS:AVERAge :FETCh:BURSt:MACCuracy:RMS:MAXimum :FETCh:BURSt:MACCuracy:PEAK:STATUs :FETCh:BURSt:MACCuracy:PEAK:AVERAge :FETCh:BURSt:MACCuracy:PEAK:MAXimum :FETCh:BURSt:MACCuracy:OSUPpress:STATUs :FETCh:BURSt:MACCuracy:OSUPpress:AVERAge :FETCh:BURSt:MACCuracy:OSUPpress:MAXimum :FETCh:BURSt:MACCuracy:PERCentile:STATUs :FETCh:BURSt:MACCuracy:PERCentile:AVERAge :FETCh:BURSt:MACCuracy:PERCentile:MAXimum :FETCh:BURSt:MACCuracy:FREQuency:STATUs :FETCh:BURSt:MACCuracy:FREQuency:AVERAge :FETCh:BURSt:MACCuracy:FREQuency:MAXimum |
| NO. OF BURSTS | |
| SET MANUAL | :CONFigure<1 2>:BURSt:MACCuracy:COUNT <num_value> |
| SET TO STANDARD | -- |
| ARFCN / FREQUENCY | see submenu SETTINGS |
| POWER SETTINGS | see submenu SETTINGS |
| X UNIT SYMB TIME | :CALCulate<1 2>::X:UNIT:TIME S SYM |
| CONDITIONS NORM EXTR | :CONFigure<1 2>:BURSt:MACCuracy:CONDitions NORMal EXTReMe |
| TRIGGER | see submenu SETTINGS |
| EDIT | -- |
| RMS EVM | :CONFigure<1 2>[:MS]:LIMit:EVMRms <num_value> |
| PEAK EVM | :CONFigure<1 2>[:MS]:LIMit:EVMPeak <num_value> |
| ORIG OFFS SUPPRESS | :CONFigure<1 2>[:MS]:LIMit:OSUPpress <num_value> |
| 95% PERCENTILE | :CONFigure<1 2>[:MS]:LIMit:PERCentile <num_value> |

| | |
|-------------------------|---|
| FREQUENCY | :CONFigure<1 2>[:MS]:LIMit:FREQuency <num_value> |
| USER LIMIT ON OFF | :CONFigure<1 2>[:MS]:LIMit:STANdard ON OFF |
| CARRIER POWER | :CONFigure<1 2>:BURSt:POWer[:IMMediate] :CALCulate<1 2>:LIMit:BURSt:POWer? |
| MEAS MAX OUTPUT PWR | :READ:BURSt:POWer? |
| INC PWR CTRL LEVEL | :READ:BURSt:POWer:LEVel? |
| NO. OF BURSTS | -- |
| SET MANUAL | :CONFigure<1 2>:BURSt:POWer:COUnT <num_value> |
| SET TO STANDARD | -- |
| SGL MEAS ON OFF | :CONFigure<1 2>[:MS]:POWer:SINGLe[:STATe] ON OFF |
| MEAS SGL PWR LEVEL | :READ:BURSt:POWer? |
| POWER CTRL LEVEL | :CONFigure<1 2>[:MS]:POWer:LEVel <num_value> |
| CLEAR SGL RESULT TAB | :CONFigure<1 2>[:MS]:POWer:SINGLe:CLEAr |
| SIGNAL POWER | :CONFigure<1 2>[:MS]:POWer:EXPEcted <num_value> |
| ARFCN / FREQUENCY | see submenu SETTINGS |
| POWER SETTINGS | see submenu SETTINGS |
| CONDITIONS NORM EXTR | :CONFigure<1 2>:BURSt:POWer:CONdITION NORMAl EXTReme |
| MEAS BANDWIDTH | :[SENSe<1 2>:]BANDwidth BWIDth[:RESolution] DEF 300 kHz 1 MHz |
| SYNC TO MIDAMBLE | :TRIGger<1 2>[:SEQuence]:SYNChronize:SOURce FRAMe TSC |
| TRIGGER | see submenu SETTINGS |
| POWER VS TIME | :CONFigure<1 2>:BURSt:PTEMplate[:IMMediate] :CALCulate<1 2>:LIMit:BURSt:PTEMplate? |
| SINGLE | :INITiate<1 2>:CONTinuous OFF; :INITiate<1 2>[:IMMediate] |
| CONTINUOUS | :INITiate<1 2>:CONTinuous ON; :INITiate<1 2>[:IMMediate] |

| | |
|-----------------------|---|
| BURST HIGH RESOLUTION | :CONFigure<1 2>:BURSt:PTEMplate:SElect TOP |
| NO. OF BURSTS | -- |
| SET MANUAL | :CONFigure<1 2>:BURSt:PTEMplate:COUNT <num_value> |
| SET TO STANDARD | -- |
| FULL BURST | :CONFigure<1 2>:BURSt:PTEMplate:SElect FULL |
| RISING EDGE | :CONFigure<1 2>:BURSt:PTEMplate:SElect RISing |
| FALLING EDGE | :CONFigure<1 2>:BURSt:PTEMplate:SElect FALLing |
| START REF MEAS | :READ:BURSt:REFErence[:IMMediate]? |
| REF MEAS AUTO USER | :CONFigure<1 2>:BURSt:REFErence:AUTO ON OFF |
| ARFCN / FREQUENCY | see submenu SETTINGS |
| POWER SETTINGS | see submenu SETTINGS |
| X UNIT SYMB TIME | :CALCulate<1 2>:X:UNIT:TIME S SYM |
| MEAS BANDWIDTH | :[SENSe<1 2>:]BANDwidth BWIDth[:RESolution] DEF 300kHz 1MHz |
| SYNC TO MIDAMBLE | :TRIGger<1 2>[:SEQuence]:SYNChronize:SOURce FRAME TSC |
| TRIGGER | see submenu SETTINGS |
| EDIT | -- |
| LIMIT LINE FILTER | -- |
| EDIT LIMIT LINE | see basic instrument |
| USER LIMIT ON OFF | :CONFigure<1 2>[:MS]:LIMIt:STANdard ON OFF |
| PAGE UP | -- |
| PAGE DOWN | -- |

| | |
|-----------------------|--|
| MODULATION SPECTRUM | :CONFIgure<1 2>:SPECTrum:MODulation[:IMMediate] :CALCulate<1 2>:LIMit:SPECTrum:MODulation? ARFCn TXBand RXBand COMBined DCSRx1800 :CALCulate<1 2>:LIMit:SPECTrum:MODulation:FAILs? ARFCn TXBand RXBand COMBined DCSRx1800 :CALCulate<1 2>:LIMit:SPECTrum:MODulation:EXCeptions? ARFCn TXBand RXBand COMBined DCSRx1800 |
| SINGLE FREQ SWEEP | :INITiate<1 2>:CONTInuous OFF; :INITiate<1 2>[:IMMediate] |
| CONTINUOUS FREQ SWEEP | :INITiate<1 2>:CONTInuous ON; :INITiate<1 2>[:IMMediate] |
| START LIST | :READ:SPECTrum:MODulation[:ALL]? |
| NO. OF BURSTS | -- |
| SET MANUAL | :CONFIgure<1 2>:SPECTrum:MODulation:COUNT <num_value> |
| SET TO STANDARD | -- |
| ARFCN ± 1.8 MHz | :CONFIgure<1 2>:SPECTrum:MODulation:RANGE ARFCn |
| TX BAND | :CONFIgure<1 2>:SPECTrum:MODulation:RANGE TXBand |
| ±1.8 MHz TX BAND | :CONFIgure<1 2>:SPECTrum:MODulation:RANGE COMBined |
| RX BAND GSM 900 | :CONFIgure<1 2>:SPECTrum:MODulation:RANGE RXBand |
| RX BAND DCS 1800 | :CONFIgure<1 2>:SPECTrum:MODulation:RANGE DCSRx1800 |
| RX BAND | :CONFIgure<1 2>:SPECTrum:MODulation:RANGE RXBand |
| RX BAND GSM 850 | :CONFIgure<1 2>:SPECTrum:MODulation:RANGE G8RXband |
| RX BAND PCS 1900 | :CONFIgure<1 2>:SPECTrum:MODulation:RANGE PCSRx1900 |
| ARFCN / FREQUENCY | see submenu SETTINGS |
| POWER SETTINGS | see submenu SETTINGS |
| RX BAND GAIN | :[SENSE<1 2>:]CORRection:RXGain:INPut[:MAGNitude] <num_value> |
| TRIGGER | see submenu SETTINGS |
| EDIT | -- |

| | |
|--------------------------|--|
| LIMIT LINE FILTER | -- |
| EDIT LIMIT LINE | see basic instrument |
| USER LIMIT ON OFF | :CONFigure<1 2>[:MS]:LIMIT:STANdard ON OFF |
| PAGE UP | -- |
| PAGE DOWN | -- |
| TRANSIENT SPECTRUM | :CONFigure<1 2>:SPECTrum:SWITChing[:IMMediate] :CALCulate<1 2>:LIMIT:SPECTrum:SWITChing? :CALCulate<1 2>:LIMIT:SPECTrum:SWITChing:FAILs? |
| SINGLE FREQ SWEEP | :INITiate<1 2>:CONTinuous OFF; :INITiate<1 2>[:IMMediate] |
| CONTINUOUS FREQ SWEEP | :INITiate<1 2>:CONTinuous ON; :INITiate<1 2>[:IMMediate] |
| START LIST | :READ:SPECTrum:SWITChing[:ALL]? |
| NO. OF BURSTS | -- |
| SET MANUAL | :CONFigure<1 2>:SPECTrum:SWITChing:COUNT <num_value> |
| SET TO STANDARD | -- |
| ARFCN / FREQUENCY | see submenu SETTINGS |
| POWER SETTINGS | see submenu SETTINGS |
| MS SFH ON OFF | :CONFigure<1 2>[:MS]:CHANnel:SFH ON OFF |
| MEAS BANDWIDTH | :[SENSe<1 2>:]BANDwidth BWIDth[:RESolution] DEF 300 kHz 1 MHz |
| TRIGGER | see submenu SETTINGS |
| EDIT | -- |
| LIMIT LINE FILTER | -- |
| EDIT LIMIT LINE | see basic instrument |
| USER LIMIT ON OFF | :CONFigure<1 2>[:MS]:LIMIT:STANdard ON OFF |
| PAGE UP | -- |

| | |
|------------------------|--|
| PAGE DOWN | -- |
| SPURIOUS | :CONFIgure<1 2>:SPURious[:IMMediate] :CALCulate<1 2>:LIMit:SPURious? TXBand OTXBand IDLeband :CALCulate<1 2>:LIMit:SPURious:FAILs? TXBand OTXBand IDLeband |
| START LIST SGL STEP | ABORT;:READ:SPURious:STEP? |
| CONT LIST SGL STEP | :READ:SPURious:STEP? |
| START LIST | :READ:SPURious [:ALL]? |
| SWEEP COUNT | -- |
| SWP COUNT TX / <>TX | :CONFIgure<1 2>:SPURious:COUNT <num_value> |
| TX BAND | :CONFIgure<1 2>:SPURious:RANGE TXBand |
| <> TX BAND | :CONFIgure<1 2>:SPURious:RANGE OTXBand |
| IDLE MODE | :CONFIgure<1 2>:SPURious:RANGE IDLeband |
| TX BAND ±2.0 MHZ | :CONFIgure<1 2>:SPURious:RANGE COMBined |
| SELECT STEP | :CONFIgure<1 2>:SPURious:STEP:COUNT? :CONFIgure<1 2>:SPURious:STEP<1..26> ON OFF |
| ARFCN / FREQUENCY | see submenu SETTINGS |
| POWER SETTINGS | see submenu SETTINGS |
| MS SFH ON OFF | :CONFIgure<1 2>[:MS]:CHANnel:SFH ON OFF |
| TX SUPPR ON OFF | :CONFIgure<1 2>[:MS]:TXSupp ON OFF |
| ANTENNA COND RAD | :CONFIgure<1 2>:SPURious:ANTenna CONDUCTed RADIated |
| SWEEPTIME STD AUTO | :CONFIgure<1 2>[:MS]:SWEeptime STANDard AUTO |
| TRIGGER | see submenu SETTINGS |
| EDIT | -- |
| LIMIT LINE FILTER | -- |

| | |
|----------------------|--|
| EDIT LIMIT LINE | see basic instrument |
| USER LIMIT ON OFF | :CONFigure<1 2>[:MS]:LIMIT:STANDARD ON OFF |
| PAGE UP | -- |
| PAGE DOWN | -- |

External Mixer Output (Option FSE-B21)

INPUT Key Group

| | |
|-----------------------|---|
| INPUT | |
| MIXER INTERNAL | : [SENSe<1 2>:]MIXer[:STATe] OFF |
| MIXER EXTERNAL | : [SENSe<1 2>:]MIXer[:STATe] ON |
| BAND LOCK ON OFF | : [SENSe<1 2>:]MIXer:BLock ON OFF |
| SELECT BAND | -- |
| BAND | : [SENSe<1 2>:]MIXer:HARMonic:BAND A Q U V E W F D G Y J |
| EVEN HARMONICS | : [SENSe<1 2>:]MIXer:HARMonic:TYPE ODD EVEN EODD |
| ODD HARMONICS | : [SENSe<1 2>:]MIXer:HARMonic:TYPE ODD EVEN EODD |
| PORTS 2 3 | : [SENSe<1 2>:]MIXer:PORT 2 3 |
| BIAS | : [SENSe<1 2>:]MIXer:BIAS <value> |
| ACCEPT BIAS | -- |
| AVG CONV LOSS LOW | : [SENSe<1 2>:]MIXer:LOSS[:LOW] <value> |
| AVG CONV LOSS HIGH | : [SENSe<1 2>:]MIXer:LOSS:HIGH <value> |
| CONV LOSS TABLE | -- |
| EDIT TABLE | -- |
| TABLE NAME | : [SENSe<1 2>:]CORRection:CVL:SElect <name> |
| VALUES | : [SENSe<1 2>:]CORRection:CVL:DATA <x1-val>,<y1-val>,<x2-val>,... input of further values in CVL table: : [SENSe<1 2>:]CORRection:CVL:MIXer <string> : [SENSe<1 2>:]CORRection:CVL:SNUMber <string> : [SENSe<1 2>:]CORRection:CVL:BAND A Q U V E W F D G Y J : [SENSe<1 2>:]CORRection:CVL:TYPE ODD EVEN EODD : [SENSe<1 2>:]CORRection:CVL:PORTs 2 3 : [SENSe<1 2>:]CORRection:CVL:BIAS <value> : [SENSe<1 2>:]CORRection:CVL:COMMeNt <string> |
| INSERT LINE | -- |

| | |
|----------------------|---|
| DELETE LINE | -- |
| COPY TABLE | -- |
| SAVE TABLE | Each change of value is saved automatically |
| PAGE UP | -- |
| PAGE DOWN | -- |
| NEW TABLE | See softkey EDIT TABLE |
| LOAD TABLE | -- |
| DELETE TABLE | :[SENSe<1 2>:]CORRection:CVL:CLEar |
| PAGE UP | -- |
| PAGE DOWN | -- |
| DEFAULT SETTINGS | -- |
| HARMONIC# | :[SENSe<1 2>:]MIXer:HARMonic <value> |
| PORTS 2 3 | :[SENSe<1 2>:]MIXer:PORT 2 3 |
| AVG CONV LOSS | :[SENSe<1 2>:]MIXer:LOSS[:LOW] <num_value> |
| BIAS | -- |
| BIAS | :[SENSe<1 2>:]MIXer:BIAS <num_value> |
| BIAS OFF | -- |
| SIGNAL ID | -- |
| SIGNAL ID | :[SENSe<1 2>:]MIXer:SIGNAL OFF ON |
| AUTO ID | :[SENSe<1 2>:]MIXer:SIGNAL OFF AUTO |
| AUTO ID THRESHOLD | :[SENSe<1 2>:]MIXer:THReshold <value> |

Contents - Chapter 7 "Remote Control - Programming Examples"

| | |
|---|------------|
| 7 Programming Examples | 7.1 |
| Programming via IEC/IEEE Bus..... | 7.1 |
| Including IEC-Bus Library for QuickBasic..... | 7.1 |
| Initialization and Default Status | 7.1 |
| Initiate Controller | 7.1 |
| Initiate Instrument..... | 7.1 |
| Transmission of Instrument Setting Commands | 7.2 |
| Switchover to Manual Control..... | 7.2 |
| Reading out Instrument Settings | 7.2 |
| Positioning a Marker and Displaying Values | 7.2 |
| Command synchronization | 7.3 |
| Service Request | 7.4 |
| Programming via the RSIB Interface | 7.6 |
| Visual Basic | 7.6 |
| Visual Basic for Applications (Winword and Excel) | 7.9 |
| C / C++ | 7.10 |

7 Programming Examples

The examples explain the programming of the instrument and can serve as a basis to solve more complex programming tasks.

QuickBASIC has been used as programming language. However, the programs can be translated into other languages.

Programming via IEC/IEEE Bus

Including IEC-Bus Library for QuickBasic

```
REM ----- Include IEC-bus library for quickbasic -----
'$INCLUDE: 'c:\qbasic\qbdecl4.bas'
```

Initialization and Default Status

The IEC bus as well as the settings of the instrument are brought into a defined default status at the beginning of every program. Subroutines "InitController" and "InitDevice" are used to this effect.

Initiate Controller

```
REM ----- Initiate controller -----
REM InitController
iecaddress% = 20                                'IEC-bus address of the
                                                'instrument
CALL IBFIND("DEV1", analyzer%)                 'Open port to the instrument
CALL IBPAD(analyzer%, iecaddress%)             'Inform controller on instrument
                                                'address
CALL IBTMO(analyzer%, 11)                       'Response time to 1 sec
REM *****
```

Initiate Instrument

The IEC-bus status registers and instrument settings of the instrument are brought into the default status.

```
REM ----- Initiate instrument -----
REM InitDevice
CALL IBWRT(analyzer%, "*CLS")                   'Reset status register
CALL IBWRT(analyzer%, "*RST")                   'Reset instrument
REM*****
```

Transmission of Instrument Setting Commands

Center frequency, span, and reference level of the instrument are set in this example.

```
REM ----- Instrument setting commands -----
CALL IBWRT(analyzer%, "FREQUENCY:CENTER 120MHz") 'Center frequency 120 MHz
CALL IBWRT(analyzer%, "FREQUENCY:SPAN 10MHz")    'Span 10 MHz
CALL IBWRT(analyzer%, "DISPLAY:TRACE:Y:RLEVEL -10dBm")
                                                    'Reference level -10dBm
REM *****
```

Switchover to Manual Control

```
REM ----- Switch instrument over to manual control -----
CALL IBLOC(analyzer%) 'Set instrument to Local state
REM *****
```

Reading out Instrument Settings

The settings made in example 3 are read out here. The abbreviated commands are used.

```
REM ----- Reading out instrument settings -----
CFfrequency$ = SPACE$(20) 'Provide text variables (20 characters)
CALL IBWRT(analyzer%, "FREQ:CENT?") 'Request center frequency
CALL IBRD(analyzer%, CFfrequency$) 'Read value

CFspan$ = SPACE$(20) 'Provide text variables (20 characters)
CALL IBWRT(analyzer%, "FREQ:SPAN?") 'Request span
CALL IBRD(analyzer%, CFspan$) 'Read value

RLevel$ = SPACE$(20) 'Provide text variables (20 characters)
CALL IBWRT(analyzer%, "DISP:TRAC:Y:RLEV?")
                                                    'Request reference level
CALL IBRD(analyzer%, RLevel$) 'Read value

REM ----- Display values on the screen -----
PRINT "Center frequency: "; CFfrequency$,
PRINT "Span: "; CFspan$,
PRINT "Reference level: "; RLevel$,
REM*****
```

Positioning a Marker and Displaying Values

```
REM ----- Examples of marker functions -----
CALL IBWRT(analyzer%, "CALC:MARKER ON;MARKER:MAX")
                                                    'Activate marker1 and start peak search
MKmark$ = SPACE$(30) 'Provide text variables (30 characters)
CALL IBWRT(analyzer%, "CALC:MARK:X?;Y?") 'Request frequency and level
CALL IBRD(analyzer%, MKmark$) 'Read value

REM ----- Display values on the screen -----
PRINT "Center frequency / level "; MKmark$,
REM *****
```

Command synchronization

The possibilities for synchronization implemented in the following example are described in Chapter 5, Section "Command Order and Command Synchronization".

```

REM ----- Examples of command synchronization -----
REM The command INITiate[:IMMEDIATE] starts a single sweep if the command
REM INIT:CONT OFF was previously sent. It should be ensured that the next
REM command is only then executed when the entire sweep is complete.

CALL IBWRT(analyzer%, "INIT:CONT OFF")

REM ----- First possibility: Use of *WAI -----
CALL IBWRT(analyzer%, "ABOR;INIT:IMM; *WAI")

REM ----- Second possibility: Use of *OPC? -----
OpcOk$ = SPACE$(2)           'Space for *OPC? - Provide response
CALL IBWRT(analyzer%, "ABOR;INIT:IMM; *OPC?")
REM ----- here the controller can service other instruments -----
CALL IBRD(analyzer%, OpcOk$) 'Wait for "1" from *OPC?

REM ----- Third possibility: Use of *OPC -----
REM In order to be able to use the service request function in conjunction
REM with a National Instruments GPIB driver, the setting "Disable
REM Auto Serial Poll" must be changed to "yes" by means of IBCONF!

CALL IBWRT(analyzer%, "*SRE 32") 'Permit service request for ESR
CALL IBWRT(analyzer%, "*ESE 1") 'Set event-enable bit for
                                'operation-complete bit
ON PEN GOSUB OpcReady           'Initialization of the
                                'service request routine

PEN ON
CALL IBWRT(analyzer%, "ABOR;INIT:IMM; *OPC")

REM Continue main program here
STOP                            'End of program

OpcReady:
REM As soon as the sweep has ended, this subroutine is activated
REM Program suitable reaction to the OPC service request.
ON PEN GOSUB OpcReady           'Enable service request routine again
RETURN
REM *****

```

Service Request

The service request routine requires an extended initialization of the instrument in which the respective bits of the transition and enable registers are set.

In order to use the service request function in conjugation with National Instruments GPIB driver, the setting "Disable Auto Serial Poll" must be changed to "yes" by means of IBCONF!

```

REM ---- Example of initialization of the SRQ in the case of errors -----
CALL IBWRT(analyzer%, "*CLS")           'Reset Status Reporting System
CALL IBWRT(analyzer%, "*SRE 168")      'Permit service request for
                                        'STAT:OPER,STAT:QUES and ESR
                                        'register
CALL IBWRT(analyzer%, "*ESE 60")       'Set event-enable bit for
                                        'command, execution, device-
                                        'dependent and query error
CALL IBWRT(analyzer%, "STAT:OPER:ENAB 32767") 'Set OPERATION enable bit for
                                        'all events
CALL IBWRT(analyzer%, "STAT:OPER:PTR 32767") 'Set appropriate OPERATION
                                        'Ptransition bits
CALL IBWRT(analyzer%, "STAT:QUES:ENAB 32767") 'Set questionable enable bits
                                        'for all events
CALL IBWRT(analyzer%, "STAT:QUES:PTR 32767") 'Set appropriate questionable
                                        'Ptransition bits
ON PEN GOSUB Srq                       'Initialization of the service
                                        'request routine

PEN ON
REM Continue main program here
STOP

```

A service request is then processed in the service request routine.

Note: the variables userN% and userM% must be pre-assigned usefully!

```

Srq:
REM ----- Service request routine -----
DO
  SRQFOUND% = 0
  FOR I% = userN% TO userM%           'Poll all bus users
    ON ERROR GOTO nouser             'No user existing
    CALL IBRSP(I%, STB%)           'Serial poll, read status byte
    IF STB% > 0 THEN                'This instrument has bits set
                                    'in the STB
      SRQFOUND% = 1
      IF (STB% AND 16) > 0 THEN GOSUB Outputqueue
      IF (STB% AND 4) > 0 THEN GOSUB Failure
      IF (STB% AND 8) > 0 THEN GOSUB Questionablestatus
      IF (STB% AND 128) > 0 THEN GOSUB Operationstatus
      IF (STB% AND 32) > 0 THEN GOSUB Esrread
    END IF
  NEXT I%
nouser:
  LOOP UNTIL SRQFOUND% = 0
  ON ERROR GOTO error handling
  ON PEN GOSUB Srq: RETURN          'Enable SRQ routine again
                                    'End of SRQ routine

```

Reading out the status event registers, the output buffer and the error/event queue is effected in subroutines.

```

REM ----- Subroutines for the individual STB bits -----
Outputqueue:                                'Reading the output buffer
Message$ = SPACE$(100)                      'Make space for response
CALL IBRD(analyzer%, Message$)
PRINT "Message in output buffer :"; Message$
RETURN

Failure:                                    'Read error queue
ERROR$ = SPACE$(100)                        'Make space for error variable
CALL IBWRT(analyzer%, "SYSTEM:ERROR?")
CALL IBRD(analyzer%, ERROR$)
PRINT " Error text :"; ERROR$
RETURN

Questionablestatus:                         'Read questionable status register
Ques$ = SPACE$(20)                          'Preallocate blanks to text variable
CALL IBWRT(analyzer%, "STaTus:QUEStionable:EvEnt?")
CALL IBRD(analyzer%, Ques$)
PRINT "Questionable Status: "; Ques$
RETURN

Operationstatus:                            'Read operation status register
Oper$ = SPACE$(20)                          'Preallocate blanks to text variable
CALL IBWRT(analyzer%, "STaTus:OPERation:EvEnt?")
CALL IBRD(analyzer%, Oper$)
PRINT "Operation Status: "; Oper$
RETURN

Esrread:                                    'Read event status register
Esr$ = SPACE$(20)                          'Preallocate blanks to text variable
CALL IBWRT(analyzer%, "*ESR?")              'Read ESR
CALL IBRD(analyzer%, Esr$)
IF (VAL(Esr$) AND 1) > 0 THEN PRINT "Operation complete"
IF (VAL(Esr$) AND 4) > 0 THEN GOTO Failure
IF (VAL(Esr$) AND 8) > 0 THEN PRINT "Device dependent error"
IF (VAL(Esr$) AND 16) > 0 THEN GOTO Failure
IF (VAL(Esr$) AND 32) > 0 THEN GOTO Failure
IF (VAL(Esr$) AND 64) > 0 THEN PRINT "User request"
IF (VAL(Esr$) AND 128) > 0 THEN PRINT "Power on"
RETURN
REM *****

REM ----- Error routine -----
Error handling:
PRINT "ERROR"                               'Output error message
STOP                                         'Stop software

```

Example:

```

Dim ibsta As Integer      ' Status variable
Dim iberr As Integer     ' Error variable
Dim ibcntl As Long      ' Count variable
Dim ud As Integer       ' Handle for measuring instrument
Dim Result As String    ' Buffer for simple results
Dim Digits As Byte      ' Number of digits of length indication
Dim TraceBytes As Long  ' Length of trace data in bytes
Dim TraceData(501) As Single ' Buffer for floating point
                          ' Binary data

' Set up connection to instrument
ud = RSDLLibfind("89.10.38.97", ibsta, iberr, ibcntl)

' Query trace data in real format
Call RSDLLibwrt(ud, "FORM:DATA REAL,32", ibsta, iberr, ibcntl)
Call RSDLLibwrt(ud, "TRACE? TRACE1", ibsta, iberr, ibcntl)

' Read number of digits of length indication
Result = Space$(20)
Call RSDLLilrd(ud, Result, 2, ibsta, iberr, ibcntl)
Digits = Val(Mid$(Result, 2, 1))

' Read length indication
Result = Space$(20)
Call RSDLLilrd(ud, Result, Digits, ibsta, iberr, ibcntl)
TraceBytes = Val(Left$(Result, Digits)) 'and store

' Read out trace data
Call RSDLLilrdTraceReal(ud, TraceData(0), TraceBytes, ibsta, iberr, ibcntl)

```

Programming examples:

- In this example, the start frequency of the instrument is queried.

```

Dim ibsta As Integer      ' Status variable
Dim iberr As Integer     ' Error variable
Dim ibcntl As Long      ' Count variable
Dim ud As Integer       ' Handle for measuring instrument
Dim Response As String  ' Response string

' Set up connection to measuring instrument
ud = RSDLLibfind("89.10.38.97", ibsta, iberr, ibcntl)
If (ud < 0) Then
    ' Error treatment
End If

' Send query command
Call RSDLLibwrt(ud, "FREQ:START?", ibsta, iberr, ibcntl)

' Provide space for response
Response = Space$(100)

' Read response from measuring instrument
Call RSDLLibrd(ud, Response, ibsta, iberr, ibcntl)

```

- In this example, a Save/Recall of the instrument setups is performed.

```
Dim ibsta As Integer      ' Status variable
Dim iberr As Integer      ' Error variable
Dim ibcntl As Long       ' Count variable
Dim ud As Integer        ' Handle for measuring instrument
Dim Cmd As String        ' Command string

' Set up connection to measuring instrument
ud = RSDLLibfind("89.10.38.97", ibsta, iberr, ibcntl)
If (ud < 0) Then
    ' Error treatment
End If

' Request instrument settings
Cmd = "SYST:SET?"
Call RSDLLibwrt(ud, Cmd, ibsta, iberr, ibcntl)

' Store instrument response in file
Call RSDLLibrdf(ud, "C:\db.sav", ibsta, iberr, ibcntl)

' Reset instrument
Call RSDLLibwrt(ud, "*RST", ibsta, iberr, ibcntl)

' and restore the previous settings
' to this end disable the END message
Call RSDLLibeot(ud, 0, ibsta, iberr, ibcntl)
' first send off command
Call RSDLLibwrt(ud, "SYST:SET ", ibsta, iberr, ibcntl)
' enable the END message again
Call RSDLLibeot(ud, 1, ibsta, iberr, ibcntl)
' and send the data
Call RSDLLibrwrtf(ud, "C:\db.sav", ibsta, iberr, ibcntl)
```

Visual Basic for Applications (Winword and Excel)

Programming hints:

The programming language Visual Basic for Applications (VBA) is supported as a macro language by various manufacturers. The programs Winword and Excel use this language for the versions Winword 97 or Excel 5.0 and higher.

For macros created with Visual Basic for Applications, the same hints are valid as for Visual Basic Applications.

Programming example:

- Using the macro `QueryMaxPeak` a single sweep with subsequent query of the maximum peak is performed. The result is entered in a Winword or Excel document.

```
Sub QueryMaxPeak()

    Dim ibsta As Integer      ' Status variable
    Dim iberr As Integer     ' Error variable
    Dim ibcnt1 As Long       ' transferred characters
    Dim ud As Integer        ' Unit Descriptor (handle)for instrument
    Dim Response As String   ' Response string

    ' Set up connection to measuring instrument
    ud = RSDLLibfind("89.10.38.97", ibsta, iberr, ibcnt1)
    If (ud < 0) Then
        Call MsgBox("Device with address 89.10.38.97 could" & _
            "not be found", vbExclamation)
    End If

    ' Determine maximum peak in the range 1-2MHZ
    Call RSDLLibwrt(ud, "*RST", ibsta, iberr, ibcnt1)
    Call RSDLLibwrt(ud, "INIT:CONT OFF", ibsta, iberr, ibcnt1)
    Call RSDLLibwrt(ud, "FREQ:START 1MHZ", ibsta, iberr, ibcnt1)
    Call RSDLLibwrt(ud, "FREQ:STOP 2MHZ", ibsta, iberr, ibcnt1)
    Call RSDLLibwrt(ud, "INIT:IMM;*WAI", ibsta, iberr, ibcnt1)
    Call RSDLLibwrt(ud, "CALC:MARK:MAX;Y?", ibsta, iberr, ibcnt1)
    Response = Space$(100)
    Call RSDLLibrd(ud, Response, ibsta, iberr, ibcnt1)
    Response = RTrim(Response) ' Cut off space

    ' Insert value in current document (Winword)
    Selection.InsertBefore (Response)
    Selection.Collapse (wdCollapseEnd)

    ' Terminate connection to measuring instrument
    Call RSDLLibonl(ud, 0, ibsta, iberr, ibcnt1)

End Sub
```

The entry of the peak value in the Winword document can be replaced as follows for Excel:

```
' Insert value in current document (Excel)
ActiveCell.FormulaR1C1 = Response
```

C / C++

Programming Hint:

- Access to the functions of the RSIB.DLL or RSIB32.DLL (Windows platforms)

The functions of the RSIB.DLL or RSIB32.DLL are declared in the header file RSIB.H. The DLL functions can be linked to a C/C++ program in different ways.

1. Enter one of the supplied import libraries (RSIB.LIB or RSIB32.DLL) into the linker options.
2. Load the library using the function `LoadLibrary()` during runtime and determine the function pointers of the DLL functions using `GetProcAddress()`. Before the end of the program, the RSIB.DLL must be unloaded again using the function `FreeLibrary()`.

When import libraries are used, the DLL is automatically loaded immediately before the application is started. At the end of the program, the DLL is unloaded again unless it is still used by other applications.

- Access to `libsib.so` functions (Unix platforms)

The functions of `libsib.so` are declared in the header file RSIB.H. Upper/lower case characters for file names are typically observed under Unix. The library functions are linked to a C/C++ program by entering the `-libsib` linker option.

The *shared library* `libsib.so` is automatically loaded on starting the application. The accessibility (for example via standard path) of the library must be ensured. Refer to the beginning of this main chapter under „Unix Environment“.

- Query of strings

If instrument responses are to be further processed as strings, a zero termination must be appended.

Example:

```
char buffer[100];
...
RSDLLibrd( ud, buffer, &ibsta, &iberr, &ibcntl );
buffer[ibcntl] = 0;
```

Programming example:

In the following C program, a single sweep is started on the instrument with the IP address 89.10.38.97 and a marker is set to the maximum level. Before the maximum level can be determined, the sweep must be terminated. Synchronization to the end of the sweep is made by triggering a service request at the end of the sweep with command "*OPC" (operation complete). The control program waits for the SRQ with the function RSDLLWaitSrq(). Then the maximum level is determined ("CALC:MARK:MAX") and the level is read out ("Y?"). Prior to readout a check is made with serial poll whether data are available (MAV bit set in status register(only for instruments with Windows NT controller).

Note: Address '@local' and DLL rsib.dll must be used for instruments with MS-DOS controller.

```
#define MAX_RESP_LEN 100

short          ibsta, iberr;
unsigned long  ibcntl;
short         ud;
short         srq;
char          Maxlevel[MAX_RESP_LEN];
char          spr;
// Determining the handle for the instrument
ud = RSDLLibfind( "89.10.38.97", &ibsta, &iberr, &ibcntl );

// If instrument exists
if ( ud >= 0 ) {

    // Setting timeout for RSDLLWaitSrq() to 10 seconds
    RSDLLibtmo( ud, 10, &ibsta, &iberr, &ibcntl );

    // Activate SRQ generation through event status register (ESR)
    // and enable ESB bit of SRE register
    RSDLLibrwt( ud, "*ESE 1;*SRE 32", &ibsta, &iberr, &ibcntl );

    // Set single sweep, trigger sweep
    // and generate SRQ at the end of the sweep with "*OPC"
    RSDLLibrwt( ud, "INIT:CONT off;INIT;*OPC", &ibsta, &iberr, &ibcntl );

    // Wait for SRQ (end of sweep)
    RSDLLWaitSrq( ud, &srq, &ibsta, &iberr, &ibcntl );

    // Clear RQS/MSS bit
    RSDLLibrsp( ud, &spr, &ibsta, &iberr, &ibcntl );

    // If sweep is terminated
    if (srq) {

        // Set marker to first maximum and query level
        RSDLLibrwt( ud, "CALC:MARK:MAX;Y?", &ibsta, &iberr, &ibcntl );

        // Check if data are available (MAV bit in status register set)
        RSDLLibrsp( ud, &spr, &ibsta, &iberr, &ibcntl );
        if (spr & 0x10) {
            // then read out data
            RSDLLilrd( ud, MaxPegel, MAX_RESP_LEN, &ibsta, &iberr, &ibcntl );
        }
    }
    // end connection to instrument
    RSDLLibonl (ud, 0, &ibsta, &iberr, &ibcntl );
}

else {
    ; // Error - instrument not found
}
}
```

Contents - Chapter 8 "Maintenance and Instrument Interfaces"

| | |
|--|------------|
| 8 Maintenance and Instrument Interfaces | 8.1 |
| Maintenance | 8.1 |
| Mechanical Maintenance | 8.1 |
| Electrical Maintenance..... | 8.1 |
| Testing the Level Measuring Accuracy | 8.1 |
| Testing the Frequency Accuracy | 8.1 |
| Instrument Interfaces | 8.2 |
| IEC Bus Interface | 8.2 |
| Interface Characteristics..... | 8.2 |
| Bus Lines..... | 8.3 |
| Interface Functions..... | 8.4 |
| IEC Bus Messages..... | 8.4 |
| Interface Messages | 8.4 |
| Instrument Messages..... | 8.5 |
| RS-232-C Interface..... | 8.6 |
| Interface Characteristics..... | 8.6 |
| Signal Lines | 8.6 |
| Interface Functions..... | 8.7 |
| Transmission Parameters | 8.7 |
| Handshake | 8.8 |
| RSIB Interface | 8.10 |
| Windows Environment | 8.10 |
| Unix Environment | 8.11 |
| RSIB Interface Functions | 8.12 |
| Variables ibsta, iberr, ibcntl | 8.12 |
| List of Interface Functions | 8.13 |
| Description of Interface Functions..... | 8.14 |
| User Interface (USER)..... | 8.21 |
| Printer Interface (LPT) | 8.22 |
| Measurement Converters (PROBE CODE)..... | 8.23 |
| Probe Connector (PROBE POWER)..... | 8.23 |
| AF-Output (AF OUTPUT) | 8.24 |
| IF Output 21.4 MHz (21.4 MHz OUT)..... | 8.24 |
| Video Output (VIDEO OUT) | 8.24 |
| Reference Output/Input (EXT REF IN/OUT) | 8.24 |
| Sweep Output (SWEEP) | 8.24 |
| External Trigger Input (EXT TRIGGER/GATE) | 8.24 |
| Noise Source Control (NOISE SOURCE) | 8.24 |
| External Keyboard (KEYBOARD)..... | 8.25 |
| Mouse Connector (MOUSE)..... | 8.25 |
| Monitor Connector (MONITOR)..... | 8.25 |

8 Maintenance and Instrument Interfaces

The following chapter contains information on the maintenance of the FSE and on the instrument interfaces.

The address of our support center and a list of all Rohde & Schwarz service centers can be found at the beginning of this manual.

Maintenance

Mechanical Maintenance

The FSE does not require any mechanical maintenance. The front panel can be cleaned from time to time using a damp, soft cloth.

Electrical Maintenance

Testing the Level Measuring Accuracy

Due to the total calibration facility by means of the built-in calibration generator, high long-term stability of the level measuring characteristics is guaranteed. It is recommended to check the measuring accuracy every two years according to the performance test. Reprogramming of the correction data by a R&S servicing shop is necessary, if tolerances are exceeded.

Testing the Frequency Accuracy

The frequency accuracy of the reference oscillator is to be checked once a year according to section 5. It is not necessary to perform this test if the instrument is operated using an external reference.

Test utility: Frequency counter of signal generator

Test setup: Measurement with frequency counter
Connect frequency counter to the REF OUT/IN socket at the rear of the instrument.

Measurement with signal generator
Apply signal with 1GHz, -10dBm to RFin.

Measurement: Settings on FSE:

```
[CENTER      1000 MHz]
[SPAN        0 MHz]
[REF REF LEVEL -10 dBm]
[MARKER COUNT ON]
[COUNTER RESOL 0.1 Hz]
```

Activate internal frequency counter (marker function)

Instrument Interfaces

IEC Bus Interface

The standard instrument is equipped with an IEC/IEEE Bus connector. An IEEE 488 interface connector is located on the rear panel of the FSE. An external controller for remote control of the instrument can be connected via the IEEE 488 interface connector using a shielded cable.

A further optional IEC/IEEE-bus interface can be installed in the FSE and is, with an installed computer option, assigned to the controller. This interface can be controlled by standard software (R&S-Basic, QUICK-Basic, etc.). It enables the remote control of the instrument via an external link to the two IEC/IEEE-bus interfaces and in addition the control of other equipment via the IEC/IEEE-bus connector at the rear of the unit (eg control of a complete test setup).

The following section describes the first IEC Bus interface over which the instrument can be remotely controlled. The characteristics of the PC2A/PC-AT controller interface depend upon the user-installed software running on the controller and is, therefore, not described here.

Interface Characteristics

- 8-bit parallel data transfer
- bidirectional data transfer
- three-line handshake
- high data transfer rate of max. 350 kbyte/s
- up to 15 instruments can be connected
- maximal length of the interconnecting cables 15 m (single connection, 2m)
- wired-OR connection if several instruments are connected in parallel.

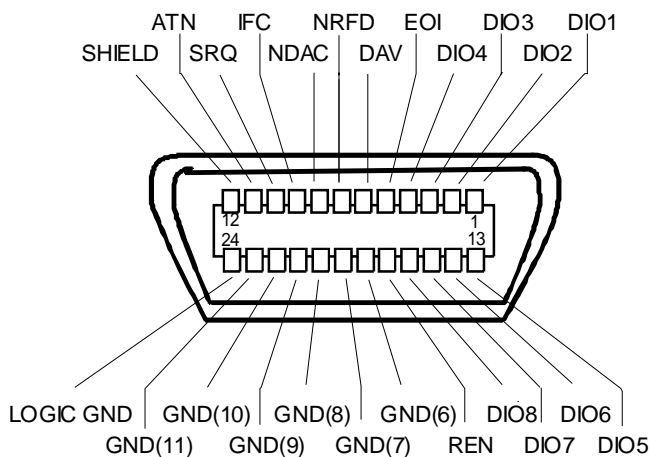

Fig. 8-1 Pin assignment of IEC-Bus interface

Bus Lines

1. Data bus with 8 lines DIO 1 to DIO 8.

The transmission is bit-parallel and byte-serial in the ASCII/ISO code. DIO1 is the least significant, DIO8 the most significant bit.

2. Control bus with 5 lines.

IFC (Interface Clear),

active low resets the interfaces of the devices connected to the default setting.

ATN (Attention),

active low signals the transmission of interface messages

inactive high signals the transmission of device messages.

SRQ (Service Request),

active low enables a device connected to send a service request to the controller.

REN (Remote Enable),

active low permits the switch over to remote control.

EOI (End or Identify),

has two functions in connection with ATN:

active low marks the end of data transmission when ATN=high

active low triggers a parallel poll when ATN=low.

3. Handshake bus with three lines.

DAV (Data Valid),

active low signals a valid data byte on the data bus.

NRFD (Not Ready For Data),

active low signals that one of the devices connected is not ready for data transfer .

NDAC (Not Data Accepted),

active low as long as the device connected is accepting the data present on the data bus.

Interface Functions

Instruments which can be remote controlled via the IEC bus can be equipped with different interface functions. Table 8-1 lists the interface functions appropriate for the instrument.

Table 8-1 Interface functions

| Control character | Interface function |
|--------------------------|---|
| SH1 | Handshake source function (source handshake), full capability |
| AH1 | Handshake sink function (acceptor handshake), full capability |
| L4 | Listener function, full capability, deaddressed by MTA. |
| T6 | Talker function, full capability, ability to respond to serial poll, deaddressed by MLA |
| SR1 | Service request function (Service Request), full capability |
| PP1 | Parallel poll function, full capability |
| RL1 | Remote/Local switch over function, full capability |
| DC1 | Reset function (Device Clear), full capability |
| DT1 | Trigger function (Device Trigger), full capability |
| C12 | Controller function, capability to send interface messages, to accept or relinquish the controller function |

IEC Bus Messages

The messages transferred via the data lines of the IEC bus can be divided into two groups:

- **interface messages**
- and
- **instrument messages.**

Interface Messages

Interface messages are transferred on the data lines of the IEC Bus when the "ATN" control line is active (LOW). They are used for communication between controller and instruments and can only be sent by the controller which currently has control of the IEC Bus.

Universal Commands

The universal commands are encoded 10 - 1F hex. They affect all instruments connected to the bus without addressing.

Table 8-2 Universal Commands

| Command | QuickBASIC command | Effect on the instrument |
|---------------------------------|--------------------------------|---|
| DCL (Device Clear) | IBCMD (controller%, CHR\$(20)) | Aborts the processing of the commands just received and sets the command processing software to a defined initial state. Does not change the instrument settings. |
| IFC (Interface Clear) | IBSIC (controller%) | Resets the interfaces to the default setting. |
| LLO (Local Lockout) | IBCMD (controller%, CHR\$(17)) | The LOC/IEC ADDR key is disabled. |
| SPE (Serial Poll Enable) | IBCMD (controller%, CHR\$(24)) | Ready for serial poll. |
| SPD (Serial Poll Disable) | IBCMD (controller%, CHR\$(25)) | End of serial poll. |
| PPU (Parallel Poll Unconfigure) | IBCMD (controller%, CHR\$(21)) | End of the parallel-poll state. |

Addressed Commands

The addressed commands are encoded 00 - 0F hex. They are only effective for instruments addressed as listeners.

Table 8-3 Addressed Commands

| Command | QuickBASIC command | Effect on the instrument |
|-------------------------------|------------------------|--|
| SDC (Selected Device Clear) | IBCLR (device%) | Aborts the processing of the commands just received and sets the command processing software to a defined initial state. Does not change the instrument setting. |
| GTL (Go to Local) | IBLOC (device%) | Transition to the "Local" state (manual control). |
| PPC (Parallel Poll Configure) | IBPPC (device%, data%) | Configure instrument for parallel poll. Additionally, the QuickBASIC command executes PPE/PPD. |

Instrument Messages

Instrument messages are transferred on the data lines of the IEC bus when the "ATN" control line is not active. ASCII code is used.

Structure and syntax of the instrument messages are described in Chapter 5. The commands are listed and explained in detail in Chapter 6.

RS-232-C Interface

The standard FSE is equipped with two serial interfaces (RS-232-C). The RS-232-C interfaces are two independent, remote-control channels, both of which may be active at the same time. The programming and interrogation commands affect the same instrument hardware. The interfaces can be set up manually in the *SETUP-GENERAL SETUP* menu in the *COM PORT1/2* table.

Each of the active RS-232-C interfaces is assigned to one of the 9-pin connectors located on the rear panel. Interface 1 is assigned to the connector COM1 and Interface 2 is assigned to the connector COM2.

Interface Characteristics

- Serial data transmission in asynchronous mode
- Bidirectional data transfer via two separate lines
- Transmission rate selectable from 110 to 19200 baud
- Logic '0' signal from +3 V to +15 V
- Logic '1' signal from -15 V to -3 V
- An external instrument (controller) can be connected.
- Software handshake (XON, XOFF)
- Hardware handshake

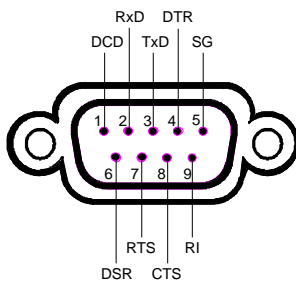

Fig. 8-2 Pin assignment of the RS-232-C interface

Signal Lines

1. Data lines

The data transmission is bit-serial in ASCII code starting with the LSB. Two lines, **RxD** and **TxD** are necessary as the minimum requirement for transmission; however, no hardware handshake is possible. For handshaking, only the XON/XOFF software handshake protocol can be used .

RxD (Receive Data)

Input, LOW = logic '1', HIGH = logic '0'.

Data line, local terminal receives data from remote station.

TxD (Transmit Data)

Output, LOW = logic '1', HIGH = logic '0'.

Data line, local terminal transmits data to remote station.

2. Control lines

DCD (Data Carrier Detect),

Not used in FSE.

DTR (Data Terminal Ready),

Output, active LOW,

Indicates that the local terminal is ready to receive data.

DSR (Data Set Ready),
Input, active LOW,
Indicates that the remote station is ready to receive data.

RTS (Request To Send),
Output, active LOW.
Indicates that the local terminal wants to transmit data.

CTS (Clear To Send),
Input, active LOW.
Used to tell the local terminal that the remote station is ready to receive data.

RI (Ring Indicator),
Not used in FSE.

Interface Functions

For interface control, several strings are defined and control characters are reserved which are based upon IEC-IEEE bus control.

Table 8-4 Control strings or control characters of the RS-232 interface

| Control string or character | Interface function |
|-----------------------------|---------------------------|
| "@REM" | Switch over to remote |
| "@LOC" | Switch over to local |
| <Ctrl Q> 11 Hex | Enables character output |
| <Ctrl S> 13 Hex | Inhibits character output |
| 0D Hex, 0A Hex | Terminator <CR>, <LF> |

Transmission Parameters

To ensure error-free data transmission, the parameters of the instrument and the controller must have the same settings. The parameters are defined in the *SETUP-GENERAL SETUP* menu.

Transmission rate (baud rate) the following transmission rates can be set in the analyzer:
110, 300, 600, 1200, 2400, 4800, 9600, 19200.

Data bits Data transmission is in 7- or 8-bit ASCII code. The first bit transmitted is the LSB (least significant bit).

Start bit Each data byte starts with a start bit. The falling edge of the start bit indicates the beginning of the data byte.

Parity bit In order to detect errors, a parity bit may be transmitted. No parity, even parity or odd parity may be selected. In addition, the parity bit can be set to logic '0' or to logic '1'.

Stop bits The transmission of a data byte is terminated by 1, 1.5 or 2 stop bits.

Example:
Transmission of character 'A' (41 hex) in 7-bit ASCII code,
with even parity and 2 stop bits:

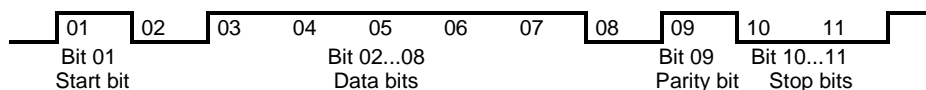

Handshake

Software handshake

In the software handshake mode of operation, the data transfer is controlled using the two control characters XON / XOFF.

The instrument uses the control character XON to indicate that it is ready to receive data. If the receive buffer is full, it sends the XOFF character via the interface to the controller. The controller then interrupts the data output until it receives another XON from the instrument. The controller indicates to the instrument that it is ready to receive data in the same way.

Cable required for software handshake

The connection of the instrument with a controller for software handshake is made by crossing the data lines. The following wiring diagram applies to a controller with a 9-pin or 25-pin configuration.

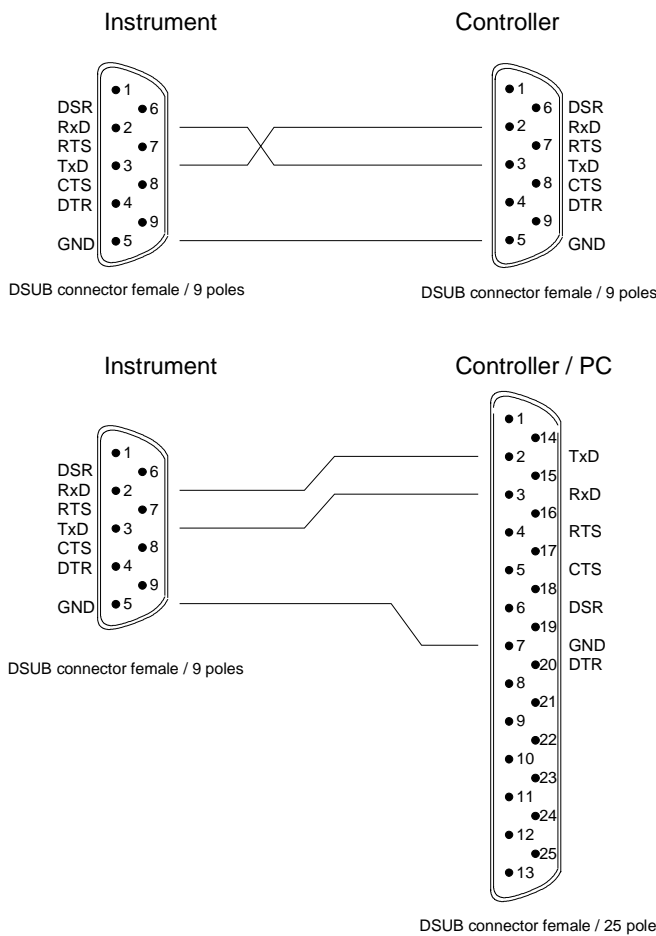

Fig. 8-3 Wiring of the data lines for software handshake

Hardware handshake

For hardware handshake, the instrument indicates that it is ready to receive data via the lines DTR and RTS. A logic '0' on both lines means 'ready' and a logic '1' means 'not ready'. The RTS line is always active (logic '0') as long as the serial interface is switched on. The DTR line thus controls the readiness of the instrument to receive data.

The readiness of the remote station to receive data is reported to the instrument via the CTS and DSR line. A logic '0' on both lines activates the data output and a logic '1' on both lines stops the data output of the instrument. The data output takes place via the TxD line.

Cable for hardware handshake

The connection of the instrument to a controller is made with a so-called zero modem cable. Here, the data, control and acknowledge lines must be crossed. The following wiring diagram applies to a controller with a 9-pin or 25-pin configuration.

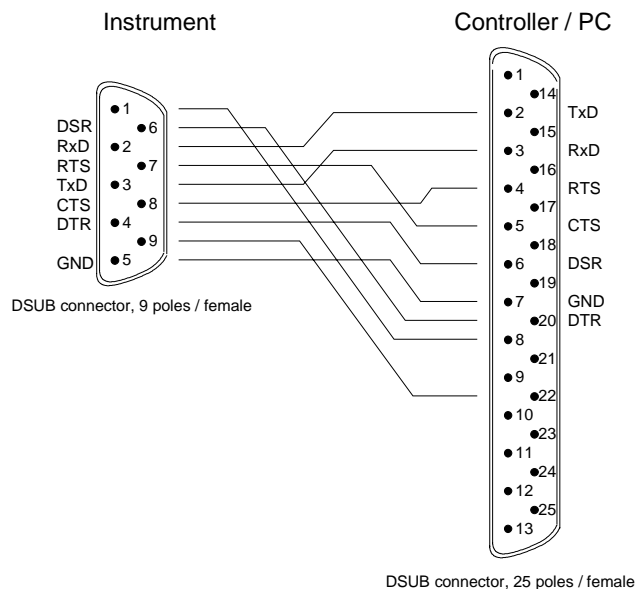
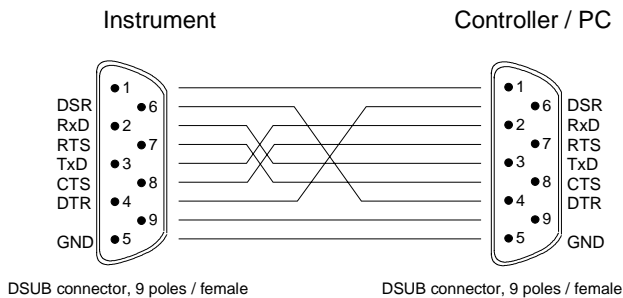

Fig. 8-4 Wiring of the data, control and acknowledge lines for hardware handshake

RSIB Interface

The RSIB interface is only available if the FSE is equipped with a controller option, FSE-B15. It allows the control of FSE by Visual C++ and VisualBasic programs but also by using the Windows applications WinWord and Excel. The functions for the programming of control applications are provided by DLLs `RSIB32.DLL` (for 32-bit applications) and `RSIB.DLL` (for 16-bit applications). Instruments with MS DOS controller option are restricted to 16-bit applications and local control in a Windows environment.

A Unix operating system can be installed on an external computer in addition to a Windows operating system. In this case, the control applications are created either in C or C++. The supported Unix operating systems include:

- Sun Solaris 2.6 Sparc Station
- Sun Solaris 2.6 Intel Platform
- Red Hat Linux 6.2 x86 Processors

Control applications may run locally on the measuring instrument as well as on a remote controller in a network. With local control, the name '@local' is specified for link setup by means of function `RSDLLibfind()`. If '@local' is not specified, the `RSIB.DLL` interprets the name as an IP address and attempts to set up a link to the device via the Winsock interface.

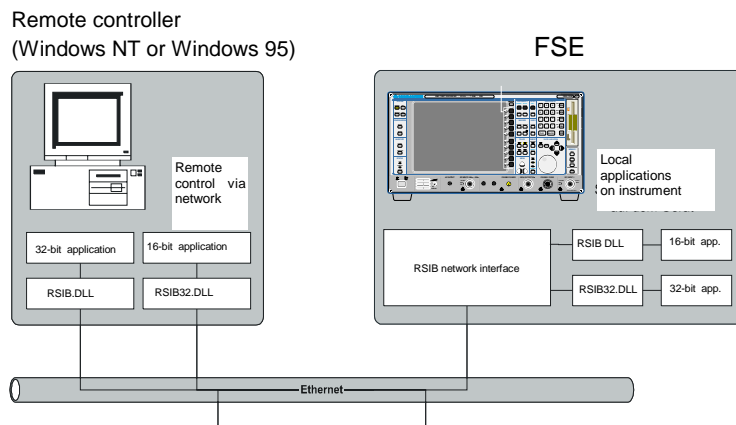

Windows Environment

To access the measuring instruments via the RSIB interface the DLL should be installed in the corresponding directories:

- `RSIB.DLL` in Windows NT `system` directory or control application directory.
- `RSIB32.DLL` in Windows NT `system32` directory or control application directory.

The DLLs are already installed in the corresponding directories on the measuring instruments.

For the different programming languages, files exist containing the declarations for the DLL functions and the error code definitions.

Instruments with Windows NT controller:

| | | |
|------------------------|--------------|---------------------|
| Visual Basic (16 bit): | 'RSIB.BAS' | (C:/R_S/Instr/RSIB) |
| Visual Basic (32 bit): | 'RSIB32.BAS' | (C:/R_S/Instr/RSIB) |
| C: | 'RSIB.H' | (C:/R_S/Instr/RSIB) |

Instruments with MS DOS controller:

Visual Basic: 'RSIB.BAS' (D:/runtime/RSIB)
 C: 'RSIBC.H' (D:/runtime/RSIB)
 Winword: 'RSIBWB.BAS' (D:/runtime/RSIB)

Thus, the RSIB directory features a program 'RSIBCNTR.EXE' with SCPI commands which can be sent to the instrument by the RSIB interface. This program can be used as a test for the function of the interface. Transit-time module VBRUN3200.DLL in the path or the Windows directory are required.

The control is performed with Visual C++ or Visual Basic programs. The local link to the internal controller is established with the name '@local'. If a remote controller is used, the instrument IP address is to be indicated here.

Via VisualBasic:

| | |
|----------------------|---|
| internal controller: | ud = RSDLLibfind ("@local", ibsta, iberr, ibcntl) |
| remote controller: | ud = RSDLLibfind ('82.1.1.200', ibsta, iberr, ibcntl) |

The return to manual operation can be performed via the front panel (*LOCAL* key) or the RSIB interface.

Via RSIB:

```
...
ud = RSDLLibloc (ud, ibsta, iberr, ibcntl);
...
```

Unix Environment

In order to access the measuring equipment via the RSIB interface, copy the `librsib.so.X.Y` file to a directory for which the control application has read rights. `X.Y` in the file name indicates the version number of the library, for example `1.0`.

The `librsib.so.X.Y` library is created as a *shared library*. The applications using the library have nothing to do with versions. They simply link the library with the `lrsib` option. The following instructions have to be observed so that linking can be successfully performed and the library can be found during the program run:

File link:

- Use the operating system command `ln` to create a file with the link name `librsib.so` and pointing to `librsib.so.X.Y` in a directory for which the control application has read rights. Example:

```
$ ln -s /usr/lib/librsib.so.1.0 /usr/lib/librsib.so
```

Linker options for creating applications:

- `-lrsib`: import library
- `-Lxxx`: path information where the import library can be found. This is where the above file link has been created. Example: `-L/usr/lib`.

Additional linker options for creating applications (only under Solaris):

- `-Rxxx`: path information where the library is searched for during the program run: `-R/usr/lib`.

Run-time environment:

- Set environment variable `LD_RUN_PATH` to the directory in which the file link has been created. This is necessary only if `librsib.so` cannot be found in the standard search path of the operating system and the `-R` linker option (only Solaris) was not specified.

For C/C++ programming, the declarations of the library functions and the definition of error codes are contained in:

C/C++: 'RSIB.H' (C:\R_S\Instr\RSIB)

RSIB Interface Functions

This following sections describe all functions of libraries 'RSIB.DLL', 'RSIB32.DLL' or "librsib.so" by means of which control applications can be written.

Variables `ibsta`, `iberr`, `ibcntl`

Same as with the National Instrument interface, successful execution of a command can be checked by means of the variables `ibsta`, `iberr` and `ibcntl`. To this end, references to the three variables are transferred to all RSIB functions. In addition, the status word `ibsta` is returned as a function value by all functions.

Status word `ibsta`

All functions send back a status word that provides information on the status of the RSIB interface. The following bits are defined:

| Bit name | Bit | Hex code | Description |
|----------|-----|----------|--|
| ERR | 15 | 8000 | This bit is set if an error occurs during a function call. If this bit is set, <code>iberr</code> contains an error code which specifies the error. |
| TIMO | 14 | 4000 | This bit is set if a timeout occurs during a function call. A timeout may occur in the following situations: <ul style="list-style-type: none"> while waiting for an SRQ with the function <code>RSDLLWaitSrQ()</code>. if no acknowledgment is received for data sent to an instrument with <code>RSDLLibwrt()</code> or <code>RSDLLilwrt()</code>. if no response from server to a data request with function <code>RSDLLibrd()</code> or <code>RSDLLilrd()</code>. |
| CMPL | 8 | 0100 | This bit is set if the reply of the IEC/IEEE-bus parser is completely read. If a reply of the parser is read with the function <code>RSDLLilrd()</code> and the buffer length is not sufficient, the bit is cleared. |

Error variable `iberr`

If the ERR bit (8000h) is set in the status word, `iberr` contains an error code that specifies the error. The RSIB has error codes of its own independent of the National Instrument interface.

| Error | Error code | Description |
|-----------------------|------------|--|
| IBERR_DEVICE_REGISTER | 1 | RSIB.DLL cannot register any new device. |
| IBERR_CONNECT | 2 | Link to the device has failed. |
| IBERR_NO_DEVICE | 3 | An interface function was called with an invalid device handle. |
| IBERR_MEM | 4 | No free memory available. |
| IBERR_TIMEOUT | 5 | Timeout has occurred. |
| IBERR_BUSY | 6 | The RSIB interface is blocked by a function not yet completed. Windows is not blocked, for example, by function <code>RSDLLibrd()</code> if data are still to be transmitted in response to this function. In this case a new call is possible. Further calls are however rejected by RSIB.DLL with error code <code>IBERR_BUSY</code> . |
| IBERR_FILE | 7 | Error in reading from or writing to a file. |
| IBERR_SEMA | 8 | Error upon creating or assigning a semaphore (only under Unix) |

Count variable - `ibcntl`

The variable `ibcntl` is updated with the number of bytes transmitted on every read and write function call.

List of Interface Functions

The DLL functions are matched to the interface functions for IEC/IEEE-bus programming from National Instruments. Functions supported by the DLLs are listed in the following table.

| Function | Description |
|----------------|--|
| RSDLLibfind() | Provides a handle for accessing a device. |
| RSDLLibwrt() | Sends a string terminated with a null to a device. |
| RSDLLilwrt() | Sends a specific number of bytes to a device. |
| RSDLLibwrtf() | Sends the contents of a file to a device. |
| RSDLLibrd() | Reads data from a device into a string. |
| RSDLLilrd() | Reads a specific number of bytes from a device. |
| RSDLLibrdf() | Reads data from a device into a file. |
| RSDLLibtmo() | Sets timeout period for RSIB functions. |
| RSDLLibsre() | Switches a device to local or remote. |
| RSDLLibloc() | Switches a device temporarily to local. |
| RSDLLibeot() | Enables/disables END message in write operations. |
| RSDLLibrsp() | Starts a serial poll and reads the status byte, only with Windows NT controller |
| RSDLLibonl() | Switches the instrument online/offline, only with Windows NT controller |
| RSDLLTestSrq() | Checks if a device has generated an SRQ. |
| RSDLLWaitSrq() | Waits until a device generates an SRQ. |
| RSDLLSwapBytes | Swaps the byte sequence for binary numeric display (only required for non-Intel platforms) |

Description of Interface Functions

Note: The description of the UNIX format is only relevant to instruments with Windows NT controller.

RSDLLibfind()

The function provides a handle for access to the device with the name udName.

VB format: Function RSDLLibfind (ByVal udName\$, ibsta%, iberr%, ibcntl&) As Integer

C-format: short FAR PASCAL RSDLLibfind(char far *udName, short far *ibsta, short far *iberr, unsigned long far *ibcntl)

C format (Unix): short RSDLLibfind(char *udName, short *ibsta, short *iberr, unsigned long *ibcntl)

Parameter: udName IP address of device

Example: ud = RSDLLibfind ("89.10.38.97", ibsta, iberr, ibcntl)

The function must be called before all other interface functions.

The function supplies a handle as a return value. The handle must be specified in all functions for accessing the instrument. If no instrument with the name udName is found, the handle will take on a negative value.

The local link on the instrument is established with the name '@local'. For setting up a link via a network, on the other hand, the IP address of the instrument must be given (eg '89.1.1.200').

RSDLLibwrt

The function sends data to the instrument with the handle ud.

VB format: Function RSDLLibwrt (ByVal ud%, ByVal Wrt\$, ibsta%, iberr%, ibcntl&) As Integer

C format: short FAR PASCAL RSDLLibwrt(short ud, char far *Wrt, short far *ibsta, short far *iberr, unsigned long far *ibcntl)

C format (Unix): short RSDLLibwrt(short ud, char *Wrt, short *ibsta, short *iberr, unsigned long *ibcntl)

Parameter: ud Device handle
Wrt String sent to the device.

Example: RSDLLibwrt(ud, "SENS:FREQ:STAR?", ibsta, iberr, ibcntl)

The function allows setting and query commands to be sent to the measuring instruments. The function RSDLLibeot() is used for defining whether the data are interpreted as a complete command.

RSDLLilwrt

The function sends Cnt bytes to the instrument with the handle ud.

VB format: Function RSDLLilwrt (ByVal ud%, ByVal Wrt\$, ByVal Cnt&, ibsta%, iberr%, ibcntl&) As Integer

C format: short FAR PASCAL RSDLLilwrt(short ud, char far *Wrt, unsigned long Cnt, short far *ibsta, short far *iberr, unsigned long far *ibcntl)

C format (Unix): short RSDLLilwrt(short ud, char *Wrt, unsigned long Cnt, short *ibsta, short *iberr, unsigned long *ibcntl)

Parameter:

| | |
|-----|---|
| ud | Device handle |
| Wrt | String sent to the IEC/IEEE-bus parser. |
| Cnt | Number of bytes sent to the instrument. |

Example: RSDLLilwrt (ud, '.....', 100, ibsta, iberr, ibcntl)

This function sends data to an instrument same as function RSDLLibwrt() but with the difference that binary data, too, can be sent. The length of the data is determined not by a zero-terminated string but by the definition of Cnt bytes. If the data are to be terminated with EOS (0Ah), the EOS byte must be appended to the string.

RSDLLibwrtf

The function sends the contents of a file to the instrument with the handle ud.

VB format: Function RSDLLibwrtf (ByVal ud%, ByVal file\$, ibsta%, iberr%, ibcntl&) As Integer

C format: short FAR PASCAL RSDLLibwrtf(short ud, char far *Wrt, short far *ibsta, short far *iberr, unsigned long far *ibcntl)

C format (Unix): short RSDLLibwrtf(short ud, char *Wrt, short *ibsta, short *iberr, unsigned long *ibcntl)

Parameter:

| | |
|------|---|
| ud | Device handle |
| file | File whose contents are sent to the instrument. |

Example: RSDLLibrdf(ud, "C:\db.sav", ibsta, iberr, ibcntl)

The function allows setting and query commands to be sent to the measuring instruments. The function RSDLLibeot() is used for defining whether the data are interpreted as a complete command.

RSDLLibrd()

The function reads data from the instrument into the string `Rd` with the handle `ud`.

VB format: Function RSDLLibrd (ByVal ud%, ByVal Rd\$, ibsta%, iberr%, ibcntl&) As Integer

C format: short FAR PASCAL RSDLLibrd(short ud, char far *Rd, short far *ibsta, short far *iberr, unsigned long far *ibcntl)

C format (Unix): short RSDLLibrd(short ud, char *Rd, short *ibsta, short *iberr, unsigned long *ibcntl)

Parameter: ud Device handle
Rd String into which the read data are copied.

Example: RSDLLibrd (ud, Rd, ibsta, iberr, ibcntl)

This function fetches replies of the IEC/IEEE-bus parser in response to a query command.

For this, a string of sufficient length must be generated when programming in Visual Basic. This can be accomplished in the definition of the string or with the command `Space$()`.

Generation of a string of the length 100: - Dim Rd as String * 100
 - Dim Rd as String
 Rd = Space\$(100)

RSDLLilrd

The function reads `Cnt` bytes from the instrument with the handle `ud`.

VB format: Function RSDLLilrd (ByVal ud%, ByVal Rd\$, ByVal Cnt&, ibsta%, iberr%, ibcntl&) As Integer

C format: short FAR PASCAL RSDLLilrd(short ud, char far *Rd, unsigned long Cnt, short far *ibsta, short far *iberr, unsigned long far *ibcntl)

Parameter: ud Device handle
cnt Maximum number of bytes copied to target string `Rd` by the DLL.

Example: RSDLLilrd (ud, RD, 100, ibsta, iberr, ibcntl)

The function reads data from an instrument same as function `RSDLLibrd()` but with the difference that here the maximum number of bytes is allowed to be copied to target string `Rd` to be defined with `Cnt`. Writing beyond a string can thus be prevented with this function. The number of bytes cut off is lost.

RSDLLibrdf()

Reads data from the instrument into the file `file` with the handle `ud`.

VB format: Function RSDLLibrdf (ByVal ud%, ByVal file\$, ibsta%, iberr%, ibcntl&) As Integer

C format: short FAR PASCAL RSDLLibrdf(short ud, char far *file, short far *ibsta, short far *iberr, unsigned long far *ibcntl)

C format (Unix): short RSDLLibrdf(short ud, char *file, short *ibsta, short *iberr, unsigned long *ibcntl)

Parameter: ud Device handle
file File into which the read data are written.

Example: RSDLLibrdf (ud, c:\db.sav, ibsta, iberr, ibcntl)

This function serves to read replies of the IEC/IEEE-bus parser that are larger than 64 KB. The file name may include the drive and path.

RSDLLibtmo

The function defines the timeout for an instrument. The default value for the timeout is 5 seconds.

VB format: Function RSDLLibtmo (ByVal ud%, ByVal tmo%, ibsta%, iberr%, ibcntl&) As Integer

C format: void FAR PASCAL RSDLLibtmo(short ud, short tmo, short far *ibsta, short far *iberr, unsigned long far *ibcntl)

C format (Unix): short RSDLLibtmo(short ud, short tmo, short *ibsta, short *iberr, unsigned long *ibcntl)

Parameter:

| | |
|-----|-----------------|
| ud | Device handle |
| tmo | Time in seconds |

Example: RSDLLibtmo (ud, 10, ibsta, iberr, ibcntl)

Timeout can occur in the following cases:

- Waiting for an SRQ with the function RSDLLWaitSrq().
- Waiting for an acknowledgment for data sent to an instrument with RSDLLibwrt() or RSDLLilwrt().
- Waiting for a reply to a data request made with function RSDLLibrd() or RSDLLilrd().

RSDLLibsre

The function switches the instrument to LOCAL or REMOTE mode.

VB format: Function RSDLLibsre (ByVal ud%, ByVal v%, ibsta%, iberr%, ibcntl&) As Integer

C format: void FAR PASCAL RSDLLibsre(short ud, short v, short far *ibsta, short far *iberr, unsigned long far *ibcntl)

C format (Unix): short RSDLLibsre(short ud, short v, short *ibsta, short *iberr, unsigned long *ibcntl)

Parameter:

| | |
|----|-------------------|
| ud | Device handle |
| v | Instrument status |
| | 0 - local |
| | 1 - remote |

Example: RSDLLibsre (ud, 0, ibsta, iberr, ibcntl)

RSDLLibloc

The function switches the instrument temporarily to LOCAL mode.

VB format: Function RSDLLibloc (ByVal ud%, ibsta%, iberr%, ibcntl&) As Integer

C format: void FAR PASCAL RSDLLibloc(short ud, short far *ibsta, short far *iberr, unsigned long far *ibcntl)

C format (Unix): short RSDLLibloc(short ud, short *ibsta, short *iberr, unsigned long *ibcntl)

Parameter: ud Device handle

Example: RSDLLibloc (ud, ibsta, iberr, ibcntl)

After switchover the instrument can be manually operated from the front panel. On the next access to the instrument by means of one of the functions of the RSIB.DLL, the instrument is switched again to the REMOTE state.

RSDLLibeot

The function enables the END message after write operations or disables it.

VB format: Function RSDLLibeot (ByVal ud%, ByVal v%, ibsta%, iberr%, ibcntl&) As Integer

C format: void FAR PASCAL RSDLLibeot(short ud, short v, short far *ibsta, short far *iberr, unsigned long far *ibcntl)

C format (Unix): short RSDLLibsre(short ud, short v, short *ibsta, short *iberr, unsigned long *ibcntl)

Parameter: ud Device handle.
v 0 - no END message
1 - send END message

Example: RSDLLibeot (ud, 1, ibsta, iberr, ibcntl)

If the END message is disabled, the data of a command can be sent by means of several successive write function calls. The END message must be enabled prior to the last data block.

RSDLLibrsp

The function carries out a Serial Poll and outputs the instrument status (only with Windows NT controller)..

VB format: Function RSDLLibrsp(ByVal ud%, spr%, ibsta%, iberr%, ibcntl&) As Integer

C format: void FAR PASCAL RSDLLibrsp(short ud, char far* spr, short far *ibsta, short far *iberr, unsigned long far *ibcntl)

C format (Unix): short RSDLLibrsp(short ud, char *spr, short *ibsta, short *iberr, unsigned long *ibcntl)

Parameter: ud Device handle.
spr Reference to status byte

Example: RSDLLibrsp(ud, spr, ibsta, iberr, ibcntl)

RSDLLWaitSrq

The function waits until the instrument triggers an SRQ with the handle ud.

VB format: Function RSDLLWaitSrq (ByVal ud%, Result%, ibsta%, iberr%, ibcntl&) As Integer

C format: void FAR PASCAL RSDLLWaitSrq(short ud, short far *result, short far *ibsta, short far *iberr, unsigned long far *ibcntl)

C format (Unix): short RSDLLWaitSrq(short ud, short *result, short *ibsta, short *iberr, unsigned long *ibcntl)

Parameter: ud Device handle
 result Reference to an integer value in which the library returns the status of the SRQ bit.
 0 - no SRQ occurred within the timeout
 1 - SRQ occurred within the timeout

Parameter: RSDLLWaitSrq(ud, result, ibsta, iberr, ibcntl);

The function waits until one of the two following events occurs:

- The instrument triggers an SRQ.
- No SRQ occurs during the timeout defined with RSDLLibtmo().

RSDLLSwapBytes

This function changes the display of binary numbers on non-Intel platforms (only with Windows NT controller)..

VB format: Not provided at present since it is required only on non-Intel platforms.

C format: void FAR PASCAL RSDLLSwapBytes(void far *pArray, const long size, const long count)

C format (Unix): void RSDLLSwapBytes(void *pArray, const long size, const long count)

Parameter: pArray Array in which modifications are made
 size Size of a single element in pArray
 count Number of elements in pArray

Example: RSDLLSwapBytes(Buffer, sizeof(float), ibcntl/sizeof(float))

This function swaps the display of various elements from *Big Endian* to *Little Endian* and vice versa. It is expected that a coherent storage area of elements of the same file type (*size* byte) is transferred to *pArray*. This function has no effect on Intel platforms.

Different types of processor architecture store data in different byte sequences. For example, Intel processors store data in the reverse order of Motorola processors. Comparison of byte sequences:

| Byte sequence | Use in | Display in memory | Description |
|---------------|---------------------------------------|---|---|
| Big Endian | Motorola processors, network standard | Most significant byte at least significant address | The <i>most significant</i> byte is at the left end of the word. |
| Little Endian | Intel processors | Least significant byte at least significant address | The <i>most significant</i> byte is at the right end of the word. |

User Interface (USER)

The user interface, located on the rear panel of the FSE, is a 25 pin Cannon connector which provides access to the two user ports (Port A and Port B). Each port is 8 bits wide (A0 - A7 and B0 -B7) and can be configured either as output or as input. The voltage levels are TTL levels (Low < 0,4 V, High > 2 V).

In addition, an internal +5 V power supply voltage is provided. The maximum load current is 100 mA.

The pin assignments for the USER connector can be seen in the following diagram:

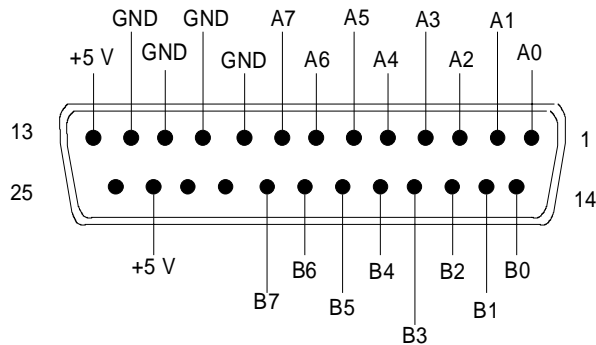
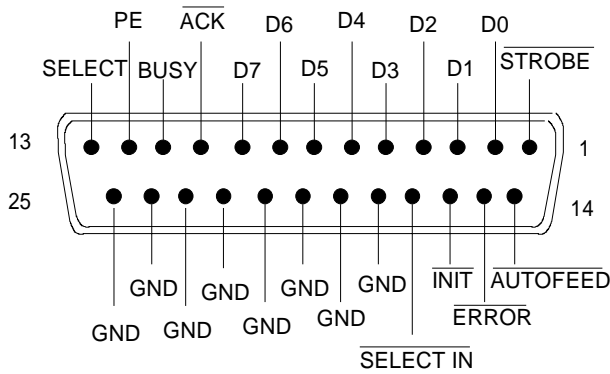

Fig. 8-5 Pin assignments for the USER connector.

The configuration of the user ports takes place in the *SETUP* menu (SETUP key) in the *GENERAL SETUP* sub-menu.

Printer Interface (LPT)

The 25-pin LPT connector on the rear panel of the FSE is provided for the connection of a printer.. The LPT interface is compatible with the CENTRONICS printer interface.



| Pin | Signal | Input (I) Output (O) | Description |
|---------|-----------|-------------------------|---|
| 1 | STROBE | O | Pulse for transmitting a data byte, min. 1µs pulse width (active LOW) |
| 2 | D0 | O | Data Line 0 |
| 3 | D1 | O | Data Line 1 |
| 4 | D2 | O | Data Line 2 |
| 5 | D3 | O | Data Line 3 |
| 6 | D4 | O | Data Line 4 |
| 7 | D5 | O | Data Line 5 |
| 8 | D6 | O | Data Line 6 |
| 9 | D7 | O | Data Line 7 |
| 10 | ACK | I | Indicates that the printer is ready to receive the next byte. (active LOW) |
| 11 | BUSY | I | Signal is active when the printer cannot accept data. (active HIGH) |
| 12 | PE | I | Signal is active when the paper tray is empty. (active HIGH) |
| 13 | SELECT | I | Signal is active when the printer is selected. (active HIGH) |
| 14 | AUTOFEED | O | When signal is active, the printer automatically performs a linefeed after each line. (active LOW) |
| 15 | ERROR | I | This signal is high when the printer has no paper, is not selected or has an error status. (active LOW) |
| 16 | INIT | O | Initialise the printer. (active LOW) |
| 17 | SELECT IN | O | If signal is active, the codes DC1/DC3 are ignored by the printer. (active LOW). |
| 18 - 25 | GND | | Ground connection. |

Fig. 8-6 Pin assignments for the LPT connector.

Measurement Converters (PROBE CODE)

The PROBE CODE connector is used for supplying power to measurement converters and the providing the correct conversion factor coding to the FSE. Using it, the conversion factors for high-impedance probes, current converters and antennas can be encoded in 10dB steps. In addition, the quantity to be measured (field strength, current and voltage) is also passed to the FSE. Active converters can be supplied with ± 10 V via the PROBE CODE connector. The following R&S accessories are deliverable with the applicable coding:

- Wide band dipole 20...80 MHz HUF-Z2
- HF current converter 100 kHz..30 MHz ESH2-Z1
- VHF current converter 20...300 MHz ESV-Z1
- Current converter 20 Hz...100 MHz EZ-17
- Preamplifier 20...1000 MHz ESV-Z2.

The pins of the PROBE CODE connector are assigned as follows:

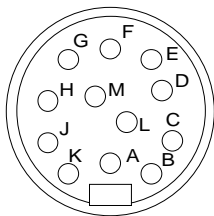

| Pin | Signal |
|-----|--|
| A | ground |
| B | +10 V, max. 50 mA |
| C | $\mu\text{V/m}$ (elec. field strength) |
| D | μA |
| E | 10 dB |
| F | 20 dB |
| G | 40 dB |
| H | 80 dB |
| K | - 10 V, max. 50 mA |
| M | factor sign inversion |

Fig 8-7 Pin assignment for the 12-pin Tuchel connector.

A 12-pin connector is used for coding (manufacturer: Tuchel, R&S part number 0018.5362.00, Tuchel type number: T3635/2). The input pins for implementing the code are connected to ground.

Example: An antenna for measurement of the electromagnetic field strength has an antenna factor of 10 dB, i.e., a field strength of 10 dB $\mu\text{V/m}$ produces a voltage at the RF input of 0 dB μV .
-> Pins C and E are connected to ground.

Probe Connector (PROBE POWER)

To allow the connection of probes, the FSE provides the PROBE POWER power connector. It delivers the power supply voltages +15 V and -12,6 V and ground.

The connector is also suited for powering the high-impedance probes from Hewlett Packard.

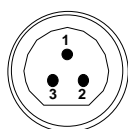

| Pin | Signal |
|-----|---------------------|
| 1 | GND |
| 2 | -12,6 V; max 150 mA |
| 3 | +15 V; max 150 mA |

AF-Output (AF OUTPUT)

A miniature telephone jack can be used at the AF OUTPUT connector to connect an external loudspeaker, a headphone set or, e.g., a LF voltmeter. The internal resistance is 10 ohms and the output voltage can be controlled in the *MARKER DEMOD* menu. When a jack is plugged in, the internal loudspeaker is automatically turned off.

IF Output 21.4 MHz (21.4 MHz OUT)

The 21,4 MHz IF signal of the FSE is available at the IF 21.4 MHz OUT BNC connector. The bandwidth corresponds to the selected bandwidth for a resolution bandwidth between 2 kHz and 10 MHz. For a resolution bandwidth below 2 kHz, the bandwidth of the output is 5 kHz.

The signal level at the IF output is 0 dBm for signals which correspond to the selected reference level.

Video Output (VIDEO OUT)

The video output delivers the logarithmic envelope curve of the IF signal independent of the level scaling on the display screen (linear or logarithmic). The bandwidth of the video signal always corresponds to one-half of the IF bandwidth and is not limited by the video filter in the measurement path.

Reference Output/Input (EXT REF IN/OUT)

When the FSE is operated with the internal reference, the internal 10 MHz reference signal is also available at the REF IN/OUT connector and thus provides the capability of, e.g., synchronisation of external instruments to the FSE. The level is 1 V RMS at 50 ohms source impedance.

For operation with an external reference, this connector becomes an input connector. The internal reference oscillator is then synchronised to the reference applied to the connector. The reference frequency can be between 1 and 16 MHz in 1 MHz steps. The necessary level is > 0 dBm.

The selection of internal or external references takes place in the *SETUP* menu.

Sweep Output (SWEEP)

The SWEEP BNC connector delivers a saw-tooth voltage between 0V and + 10 V which, for the frequency spectrum display, is proportional to the instantaneous frequency. The selected start frequency corresponds to a voltage of 0V and the stop frequency corresponds to a voltage of +10 V.

External Trigger Input (EXT TRIGGER/GATE)

The EXT TRIG/GATE connector is used for controlling the measurement via an external signal.

Trigger voltage range: -5 V ... +5 V

Noise Source Control (NOISE SOURCE)

Using the NOISE SOURCE connector, an external noise source can be switched on/off, in order, e.g., to measure the noise figure of Units Under Test (UUTs). Usual noise sources require a +28 V signal to be turned on. At 0 V, they are turned off. These switching voltages are delivered by the connector.

External Keyboard (KEYBOARD)

A 5-pin DIN connector is provided to allow connecting an external keyboard. Because of its low interference radiation, the PSA-Z1 keyboard is recommended (Order No. 1009.5001.31). However, any other multi-function keyboard may also be used.

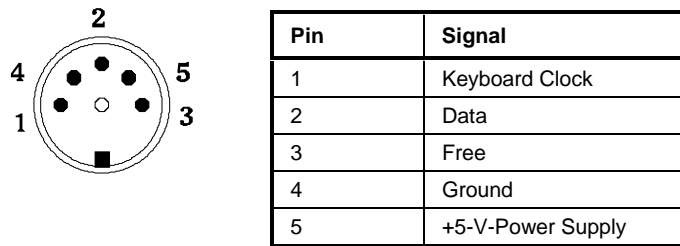

Fig. 8-8 Pin assignments of the KEYBOARD connector.

Mouse Connector (MOUSE)

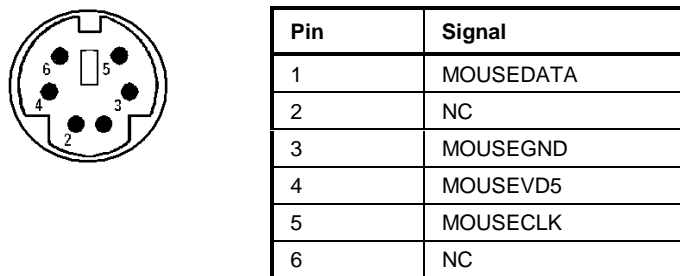

Fig 8-9 Pin assignments for the MOUSE connector.

Monitor Connector (MONITOR)

| Pin | Signal | Pin | Signal |
|-----|-----------|-----|-----------|
| 1 | R | 9 | NC |
| 2 | G | 10 | GND |
| 3 | B | 11 | MID0 (NC) |
| 4 | MID2 (NC) | 12 | MID1 (NC) |
| 5 | NC | 13 | HSYNC |
| 6 | R-GND | 14 | VSYSN |
| 7 | G-GND | 15 | NC |
| 8 | B-GND | | |

Fig. 8-10 Pin assignments of the MONITOR connector.

Contents - Chapter 9 "Error Messages"

9 List of Error Messages

| | |
|--|------------|
| SCPI-Specific Error Messages | 9.1 |
| Command Error - Faulty command; sets bit 5 in the ESR register. | 9.1 |
| Execution Error - Error on execution of a command; sets bit 4 in the ESR register..... | 9.4 |
| Device Specific Error; sets bit 3 in the ESR register | 9.7 |
| Query Error - Error in data request; sets bit 2 in the ESR register | 9.7 |

9 List of Error Messages

The following list contains the error messages for errors occurring in the instrument. The meaning of negative error codes is defined in SCPI, positive error codes mark errors specific of the instrument.

Error messages are entered in the error/event queue of the status reporting system in the remote control mode and can be queried with the command `SYSTEM:ERROR?`. The answer format of FSE to the command is as follows:

`<error code>, "<error text with queue query>; <remote control command concerned>"`

The indication of the remote control command with prefixed semicolon is optional.

Example:

The command `"TEST:COMMAND"` generates the following answer to the query `SYSTEM:ERROR?` :

`-113,"Undefined header;TEST:COMMAND"`

The table contains the error code in the left-hand column. In the right-hand column the error text being entered into the error/event queue or being displayed is printed in bold face. Below the error text, there is an explanation as to the respective error.

SCPI-Specific Error Messages

No Error

| Error code | Error text in the case of queue poll Error explanation |
|------------|--|
| 0 | No error This message is output if the error queue does not contain any entries. |

Command Error - Faulty command; sets bit 5 in the ESR register.

| Error code | Error text in the case of queue poll Error explanation |
|------------|--|
| -100 | Command Error The command is faulty or invalid. |
| -101 | Invalid Character The command contains an invalid sign. Example: A header contains an ampersand, " <code>SENSe&</code> ". |
| -102 | Syntax error The command is invalid. Example: The command contains block data the instrument does not accept. |
| -103 | Invalid separator The command contains an impermissible sign instead of a separator. Example: A semicolon is missing after the command. |

Continuation: Command Error

| Error code | Error text in the case of queue poll Error explanation |
|------------|--|
| -104 | Data type error The command contains an invalid value indication. Example: ON is indicated instead of a numeric value for frequency setting. |
| -105 | GET not allowed A Group Execute Trigger (GET) is within a command line. |
| -108 | Parameter not allowed The command contains too many parameters. Example: Command SENSe:FREQuency:CENTer permits only one frequency indication. |
| -109 | Missing parameter The command contains too few parameters. Example: The command SENSe:FREQuency:CENTer requires a frequency indication. |
| -110 | Command header error The header of the command is faulty. |
| -111 | Header separator error The header contains an impermissible separator. Example: the header is not followed by a "White Space", " *ESE255 " |
| -112 | Program mnemonic too long The header contains more than 12 characters. |
| -113 | Undefined header The header is not defined for the instrument. Example: *XYZ is undefined for every instrument. |
| -114 | Header suffix out of range The header contains an impermissible numeric suffix. Example: SENSe3 does not exist in the instrument. |
| -120 | Numeric data error The command contains a faulty numeric parameter. |
| -121 | Invalid character in number A number contains an invalid character. Example: An "A" in a decimal number or a "9" in an octal number. |
| -123 | Exponent too large The absolute value of the exponent is greater than 32000. |
| -124 | Too many digits The number includes too many digits. |
| -128 | Numeric data not allowed The command includes a number which is not allowed at this position. Example: The command INPut:COUPLing requires indication of a text parameter. |
| -130 | Suffix error The command contains a faulty suffix. |
| -131 | Invalid suffix The suffix is invalid for this instrument. Example: nHz is not defined. |
| -134 | Suffix too long The suffix contains more than 12 characters. |

Continuation: Command Error

| Error code | Error text in the case of queue poll Error explanation |
|------------|--|
| -138 | Suffix not allowed A suffix is not allowed for this command or at this position of the command. Example: The command *RCL does not permit a suffix to be indicated. |
| -140 | Character data error The command contains a faulty text parameter |
| -141 | Invalid character data The text parameter either contains an invalid character or it is invalid for this command. Example: Write error with parameter indication;INPut:COUPLing XC. |
| -144 | Character data too long The text parameter contains more than 12 characters. |
| -148 | Character data not allowed The text parameter is not allowed for this command or at this position of the command. Example: The command *RCL requires a number to be indicated. |
| -150 | String data error The command contains a faulty string. |
| -151 | Invalid string data The command contains a faulty string. Example: An END message has been received prior to the terminating apostrophe. |
| -158 | String data not allowed The command contains a valid string at a position which is not allowed. Example: A text parameter is set in quotation marks, INPut:COUPLing "DC" |
| -160 | Block data error The command contains faulty block data. |
| -161 | Invalid block data The command contains faulty block data. Example: An END message was received prior to reception of the expected number of data. |
| -168 | Block data not allowed The command contains valid block data at an impermissible position. Example: The command *RCL requires a number to be indicated. |
| -170 | Expression error The command contains an invalid mathematical expression. |
| -171 | Invalid expression The command contains an invalid mathematical expression. Example: The expression contains mismatching parentheses. |
| -178 | Expression data not allowed The command contains a mathematical expression at an impermissible position. |
| -180 | Macro error A faulty macro has been defined, or an error has occurred during execution of a macro. |
| -181 | Invalid outside macro definition A macro parameter placeholder was encountered outside of a macro definition. |
| -183 | Invalid inside macro definition A macro definition is syntactically wrong. |
| -184 | Macro parameter error A command inside the macro definition has the wrong number or type of parameters. |

Execution Error - Error on execution of a command; sets bit 4 in the ESR register

| Error code | Error text in the case of queue poll Error explanation |
|------------|---|
| -200 | Execution error Error on execution of the command. |
| -201 | Invalid while in local The command is not executable while the device is in local due to a hard local control. Example: The device receives a command which would change the rotary knob state, but the device is in local so the command can not be executed. |
| -202 | Settings lost due to rtl A setting associated with hard local control was lost when the device changed to LOCS from REMS or to LWLS from RWLS. |
| -210 | Trigger error Error on triggering the device. |
| -211 | Trigger ignored The trigger (GET, *TRG or trigger signal) was ignored because of device timing considerations. Example: The device was not ready to respond. |
| -212 | Arm ignored An arming signal was ignored by the device. |
| -213 | Init ignored Measurement initialisation was ignored as another measurement was already in progress. |
| -214 | Trigger deadlock The trigger source for the initiation of measurement is set to GET and subsequent measurement is received. The measurement cannot be started until a GET is received, but the GET would cause an interrupted-error) |
| -215 | Arm deadlock The trigger source for the initiation of measurement is set to GET and subsequent measurement is received. The measurement cannot be started until a GET is received, but the GET would cause an interrupted-error. |
| -220 | Parameter error The command contains a faulty or invalid parameter. |
| -221 | Settings conflict There is a conflict between setting of parameter value and instrument state. |
| -222 | Data out of range The parameter value lies out of the permissible range of the instrument. |
| -223 | Too much data The command contains too many data. Example: The instrument does not have sufficient storage space. |
| -224 | Illegal parameter value The parameter value is invalid. Example: The text parameter is invalid , TRIGger:SWEEp:SOURce TASTE |

Continuation: Execution Error

| Error code | Error text in the case of queue poll Error explanation |
|------------|---|
| -230 | Data corrupt or stale The data are incomplete or invalid. Example: The instrument has aborted a measurement. |
| -231 | Data questionable The measurement accuracy is suspect. |
| -240 | Hardware error The command cannot be executed due to problems with the instrument hardware. |
| -241 | Hardware missing Hardware is missing. Example: An option is not fitted. |
| -250 | Mass storage error A mass storage error occurred. |
| -251 | Missing mass storage The mass storage is missing. Example: An option is not installed. |
| -252 | Missing media The media is missing. Example: There is no floppy in the floppy disk drive. |
| -253 | Corrupt media The media is corrupt. Example: The floppy is bad or has the wrong format. |
| -254 | Media full The media is full. Example: There is no room on the floppy. |
| -255 | Directory full The media directory is full. |
| -256 | File name not found The file name cannot be found on the media. |
| -257 | File name error The file name is wrong. Example: An attempt is made to copy to a duplicate file name. |
| -258 | Media protected The media is protected. Example: The write-protect tab on the floppy is present. |
| -260 | Expression error The expression contains an error. |
| -261 | Math error in expression The expression contains a math error. Example: Divide-by-zero. |

Continuation: Execution Error

| Error code | Error text in the case of queue poll Error explanation |
|------------|---|
| -270 | Macro error Error on the execution of a macro. |
| -271 | Macro syntax error The macro definition contains a syntax error. |
| -272 | Macro execution error The macro definition contains an error. |
| -273 | illegal macro label An illegal macro label is defined in the *DMC command. Example: The label is too long. The label is identical with the common command header or contains an invalid header syntax. |
| -274 | Macro parameter error The macro definition improperly uses a macro parameter placeholder. |
| -275 | Macro definition too long The macro definition is too long. |
| -276 | Macro recursion error The command sequence defined by the macro is trapped in a program loop. Example: The event that would allow the loop to be exited does not occur. |
| -277 | Macro redefinition not allowed The macro label defined in the *DMC command is already defined elsewhere. |
| -278 | Macro header not found The macro label in the *GMC? query is not yet defined. |
| -280 | Program error Error on the execution of a down-loaded program. |
| -281 | Cannot create program The program cannot be created. |
| -282 | illegal program name The name of the program is illegal. Example: The name relates to a non-existing program. |
| -283 | illegal variable name The inputted variable does not exist in the program. |
| -284 | Program currently running The desired operation is not possible while the program is running. Example: A running program cannot be deleted. |
| -285 | Program syntax error The down-loaded program contains a syntax error. |
| -286 | Program runtime error |

Device Specific Error; sets bit 3 in the ESR register

| Error code | Error test in the case of queue poll Error explanation |
|-------------------|--|
| -300 | Device-specific error FSE-specific error not defined in greater detail. |
| -310 | System error This error message suggests an error within the instrument. Please inform the R&S Service. |
| -311 | Memory error Error in the instrument memory. |
| -312 | PUD memory lost Loss of the protected user data stored using the *PUD command. |
| -313 | Calibration memory lost Loss of the non-volatile calibration data stored using the *CAL? command. |
| -314 | Save/recall memory lost Loss of the non-volatile data stored using the *SAV command. |
| -315 | Configuration memory lost Loss of the non-volatile configuration data stored by the instrument. |
| -330 | Self-test failed The selftest could not be executed. |
| -350 | Queue overflow This error code is entered in the queue instead of the actual error code if the queue is full. It indicates that an error has occurred but not been accepted. The queue can accept 5 entries. |

Query Error - Error in data request; sets bit 2 in the ESR register

| Error code | Error text in the case of queue poll Error explanation |
|-------------------|---|
| -400 | Query error General error occurring when data are requested by a query. |
| -410 | Query INTERRUPTED The query has been interrupted. Example: After a query, the instrument receives new data before the response has been sent completely. |
| -420 | Query UNTERMINATED The query is incomplete. Example: The instrument is addressed as a talker and receives incomplete data. |
| -430 | Query DEADLOCKED The query cannot be processed. Example: The input and output buffers are full, the instrument cannot continue operation. |
| -440 | Query UNTERMINATED after indefinite response A query is in the same command line after a query which requests an indefinite response. |

10 Index

Note:

- The softkeys are listed alphabetically under the keyword "Softkey".
- For each softkey, the page in chapter 6 containing the description of the corresponding remote command is quoted in addition.
- The assignment between IEEE-bus commands and softkeys is described in Chapter 6, Section "Table of Softkeys with IEC/IEEE-Bus Command Assignment".
- Chapter 6 contains an alphabetical list of all IEEE-bus commands

A

| | |
|--|------------|
| Abort | |
| hardcopy | 4.51, 4.52 |
| macro | 4.49 |
| ACP measurement | 4.114 |
| absolute/relative | 4.119 |
| bandwidth | 4.116 |
| channel spacing | 4.117 |
| channels | 4.114 |
| filter | 4.116 |
| limits | 4.117 |
| standard | 4.115 |
| Addressed command | 8.5 |
| Adjacent channel power measurement | 4.114 |
| Administrator identification | 1.23 |
| Alphanumeric parameter | |
| editing | 3.17 |
| AM modulation | 4.204 |
| Analog trace | 4.165 |
| Ascii # | 5.14 |
| Attenuation | 4.100 |
| Attenuator (tracking generator) | 4.193 |
| AUI connector | 1.45, 1.74 |
| Autopeak detector | 4.163 |
| Average | 4.158 |
| continuous sweep | 4.159 |
| signal per sweep | 4.139 |
| single sweep | 4.159 |
| summary markers | 4.140 |
| sweep count | 4.158 |
| Average detector | 4.164 |
| Axis labelling | 3.7 |

B

| | |
|-------------------------|------------|
| Bandwidth | |
| channel | 4.116 |
| occupied | 4.124 |
| resolution | 4.171 |
| video | 4.172 |
| Beeper | 4.40 |
| Block data | 5.14 |
| BNC connector | 1.44, 1.73 |
| Boolean parameter | 5.13 |

C

| | |
|-------------------|-------|
| Calibration | 4.9 |
| method | 4.201 |

| | |
|--------------------------------|------------|
| CCVS signal | 4.206 |
| CD-ROM installation | 1.36 |
| Center frequency | 4.87 |
| Channel | |
| bandwidth | 4.116 |
| power measurement | 4.118 |
| power, absolute/relative | 4.119 |
| spacing | 4.117 |
| Characters, special | 6.2 |
| Clear/Write | 4.157 |
| Clock | 4.39 |
| Colon | 5.14 |
| COM1/2 interface | 4.36, 4.42 |
| Comma | 5.14 |
| Command | |
| # | 5.14 |
| addressed | 8.5 |
| colon | 5.14 |
| comma | 5.14 |
| header | 5.10 |
| line | 5.12 |
| long form | 5.11 |
| overlapping execution | 5.17 |
| query | 5.12 |
| question mark | 5.12, 5.14 |
| quotation mark | 5.14 |
| recognition | 5.16 |
| sequence | 5.17 |
| short form | 5.11 |
| structure | 5.9 |
| suffix | 5.11 |
| synchronization | 5.17 |
| syntax elements | 5.14 |
| universal | 8.5 |
| white space | 5.14 |
| Common commands | 6.4 |
| CONDition register part | 5.19 |
| Configuration | 4.20 |
| recall | 4.75 |
| reset | 4.2 |
| save | 4.66 |
| Copy | |
| file | 4.69 |
| limit line | 4.150 |
| trace | 4.160 |
| Coupling | 4.170 |
| default settings | 4.173 |
| define | 4.176 |
| Cursor keys | 3.14 |

D

| | |
|--------------------------|----------|
| D Lines | 4.144 |
| Data set | |
| creation | 4.75 |
| partial | 4.73 |
| recall | 4.75 |
| save | 4.70 |
| Date | 4.45 |
| dB*/MHz | 4.97 |
| dB μ A/MHz | 4.97 |
| dB μ A/mMHz | 4.97 |
| dB μ V/MHz | 4.97 |
| dB μ V/mMHz | 4.97 |
| dBmV/MHz | 4.97 |
| DCL | 5.16 |
| Default | |
| commands | 6.1 |
| instrument settings | 4.2 |
| Delete | |
| file | 4.69 |
| line of transducer table | 4.26 |
| macro | 4.83 |
| message | 4.16 |
| transducer factor/set | 4.23 |
| Delta marker | 4.128 |
| step size | 4.132 |
| Demodulation | 4.109 |
| Detector | |
| auto select | 4.163 |
| autopeak | 4.163 |
| average | 4.164 |
| max peak | 4.163 |
| min peak | 4.163 |
| RMS | 4.164 |
| sample | 4.164 |
| Device | |
| reset (hardcopy) | 4.64 |
| reset (overall) | 4.2 |
| status | 4.13 |
| DIFOVL | 3.4 |
| Directory | |
| create | 4.69 |
| rename | 4.69 |
| Disable | |
| front panel | 3.19 |
| keyboard | 3.19 |
| Disk formatting | 4.69 |
| Display | |
| configuration | 4.3 |
| energy-saving | 1.21 |
| mean value | 4.139 |
| rms value | 4.139 |
| Display mode | |
| full screen | 3.9, 4.4 |
| split screen | 3.8, 4.4 |
| Double dagger | 5.14 |
| Driver | |
| installation | 1.75 |
| NDIS | 1.76 |
| ODI | 1.75 |
| packet | 1.78 |
| printer | 1.28 |
| software | 1.39 |

E

| | |
|-------------------------|------|
| Electrostatic discharge | 1.18 |
| ENABle register part | 5.19 |
| Energy saving mode | 1.21 |

| | |
|------------------------------------|------------|
| Enhancement labels | 3.6 |
| Entry | |
| abortion | 3.16 |
| alphanumeric parameters | 3.17 |
| mouse control | 3.22 |
| numeric parameter | 3.16 |
| table | 3.18 |
| termination | 3.16 |
| window | 3.15 |
| Error messages | 9.1 |
| Error-queue query | 5.33 |
| ESE (event status enable register) | 5.22 |
| ESR (event status register) | 5.22 |
| Ethernet Adapter | 1.44, 1.73 |
| EVENT register part | 5.19 |
| Event status enable register (ESE) | 5.22 |
| Event status register (ESR) | 5.22 |
| EXT ALC modulation | 4.204 |
| Ext Trig/Gate input | 8.24 |
| External noise source | 4.32 |
| ExtRef | 3.4 |

F

| | |
|--------------------|------------------|
| FFT filter | 4.174 |
| File | |
| copy | 4.69 |
| delete | 4.69 |
| rename | 4.69 |
| sort | 4.69 |
| Firmware | |
| options (enabling) | 4.31 |
| options (info) | 4.14 |
| update | 1.38, 1.70, 4.47 |
| version | 4.13 |
| FM modulation | 4.204 |
| Frequency | |
| axis labelling | 3.7 |
| counter | 4.111 |
| line | 4.143 |
| measurement window | 4.84 |
| offset | 4.88 |
| start | 4.84 |
| stop | 4.86 |
| zoom | 4.93 |
| Front panel | |
| disable | 3.19 |
| keyboard emulation | 3.21, 3.23 |
| FTP operation | 1.55, 1.85 |
| Full screen | 3.9, 4.4 |
| Function test | 1.22 |
| Fuse | 1.19, 1.57 |

G

| | |
|-----------------------------|------|
| GET (Group Execute Trigger) | 5.16 |
| GPIB | |
| address | 4.34 |
| interface | 8.2 |

H

| | |
|-----------|------------|
| Handshake | 8.8 |
| Hardcopy | |
| abort | 4.51, 4.52 |
| comments | 4.57 |
| format | 4.59, 4.63 |
| items | 4.55 |

- output device..... 4.60
- position..... 4.56
- printer..... 4.58
- settings..... 4.54
- start..... 4.50, 4.52
- Hardware
 - configuration..... 4.14
 - indication of settings..... 3.5
 - installed options..... 4.14
- Header..... 5.10
- Help line editor..... 3.17

- I
- I/Q modulation 4.205
- IEC/IEEE-bus
 - address 4.34, 4.40
 - interface 8.2
 - output device address 4.63
- I/OVLD 3.4
- Indication
 - hardware settings 3.5
 - instrument settings 3.6
 - marker information..... 3.5
 - screen 3.4
- Input
 - attenuator..... 4.100
 - Ext Trig/Gate..... 8.24
 - external reference..... 8.24
- Input buffer 5.15
- Installation
 - CD-ROM 1.36
 - firmware update..... 1.38, 4.47
 - keyboard 1.25
 - monitor 1.26
 - mouse 1.24
 - network printer..... 1.34
 - printer..... 1.28
 - rack 1.19
 - Windows NT software 1.39
- Instrument functions 4.1
- Instrument settings
 - indication..... 3.6
 - power up 4.76
 - preset..... 4.2, 4.76
- Interface
 - IEC/IEEE-bus 8.2
 - printer..... 8.22
 - RS-232-C 8.6
 - RSIB..... 8.10
- Interrupt..... 5.32
- IST flag..... 5.22

- K
- KERMIT..... 1.86
- Key
 - CAL 4.9
 - CENTER 4.87, 6.193
 - CONFIG 4.68
 - COUPLING..... 4.170
 - cursor..... 3.14
 - D LINES 4.143
 - DELTA..... 4.128
 - DISPLAY..... 4.3
 - HOLD..... 3.19
 - INFO 4.13
 - INPUT..... 4.100
 - LIMITS 4.147
 - LOCAL..... 4.49
 - MENU..... 3.12
 - MKR..... 4.141
 - MODE..... 4.18
 - NORMAL 4.105
 - numeric keypad..... 3.13
 - PRESET 4.2, 6.231
 - RANGE..... 4.98
 - RECALL..... 4.75
 - REF 4.94
 - roll-key 3.14
 - SAVE..... 4.70
 - SEARCH..... 4.133
 - SETTINGS..... 4.54
 - SETUP..... 4.20
 - SPAN..... 4.91
 - START (frequency)..... 4.84
 - START (hardcopy) 4.50, 4.52, 6.122
 - STEP 3.20
 - STOP..... 4.86
 - SWEEP..... 4.180
 - TRACE1 to 4..... 4.156
 - TRIGGER 4.178
 - USER..... 4.80
- Keyboard
 - configuration 4.47
 - connection 1.25, 1.62
 - connector..... 8.25
 - disable 3.19
 - external..... 3.21

- L
- Level
 - attenuation..... 4.100
 - control, external 4.204
 - line 4.145
 - maximum 4.95
 - mixer..... 4.101
 - offset (tracking generator) 4.193
 - range..... 4.98
 - reference..... 4.94
 - unit..... 4.96
- LF demodulation..... 4.109
- Limit line..... 4.147
 - copy..... 4.150
 - delete..... 4.150
 - edit..... 4.151
 - save..... 4.155
 - select..... 4.148
 - shift..... 4.155
 - value 4.154
- Line
 - display 1,2..... 4.145
 - frequency 1, 2 4.145
 - limit 4.148
 - reference..... 4.145
 - threshold..... 4.145
 - time 1, 2 4.146
- LO Lvd..... 3.4
- LO Lvl 3.4
- LO unl 3.4
- Login/logout (NT controller) 1.23
- Lower case..... 6.2
- LPT interface..... 8.22

- M**
- Macro
 - abort..... 4.49
 - definition..... 4.82
 - start..... 4.80
 - Maintenance..... 8.1
 - Manual operation..... 3.1
 - return to..... 4.49, 5.3
 - Marker..... 4.105
 - center..... 4.141
 - delta..... 4.128
 - demodulation..... 4.110
 - indication..... 3.5
 - info..... 4.109
 - n-dB-down..... 4.137
 - normal..... 4.105
 - peak..... 4.134, 4.141
 - search..... 4.133
 - search limit..... 4.137
 - signal track..... 4.108
 - step size..... 4.127
 - zoom..... 4.109
 - Max hold..... 4.159
 - Max peak detector..... 4.163
 - Mean power (GSM burst)..... 4.139
 - Measurement
 - frequency-converting..... 4.202
 - recall..... 4.75
 - save..... 4.66
 - transmission..... 4.194
 - window..... 4.3
 - Measurement converters..... 4.20
 - connector..... 8.22, 8.23
 - Memory
 - battery-backed-up..... 1.21
 - battery-powered..... 1.58
 - configuration..... 4.68
 - Menu overview..... 3.24
 - Menu switching..... 3.11
 - MICROSOFT NET operation..... 1.49, 1.83
 - Min hold..... 4.160
 - Min peak detector..... 4.163
 - Minimum search..... 4.134
 - Mixer level..... 4.101
 - Mode..... 4.18
 - signal analysis..... 4.84
 - tracking generator..... 4.192
 - Modification level of modules..... 4.14
 - Modulation
 - AM..... 4.204
 - EXT ALC..... 4.204
 - FM..... 4.204
 - I/Q..... 4.205
 - Modulation filter..... 4.116
 - Monitor
 - connecting..... 4.39
 - connection..... 1.26
 - connector..... 8.25
 - Mouse
 - configuration..... 4.46
 - connection..... 1.24, 1.58
 - connector..... 8.25
 - control..... 3.22
- N**
- NDIS (driver)..... 1.76
 - Network drivers..... 1.75
 - Network operating system
 - FTP..... 1.55, 1.85
 - MICROSOFT NET..... 1.49, 1.80
 - NOVELL NETWARE..... 1.49, 1.78, 1.81
 - TCP/IP..... 1.54, 1.85
 - Network printer connection..... 1.34
 - Noise power density measurement..... 4.112
 - Noise source, external..... 4.32
 - NOVELL NETWARE operation..... 1.49, 1.81
 - NT controller..... 1.23
 - NTRansition register part..... 5.19
 - Numeric keypad..... 3.13
 - Numeric parameter
 - editing..... 3.16
 - Numerical values (command)..... 5.13
- O**
- OCXO..... 3.4
 - ODI drivers..... 1.75
 - Offset frequency..... 4.88
 - Operating mode
 - signal analysis..... 4.84
 - tracking generator..... 4.192
 - Option
 - FSE-B3 - TV Demodulator..... 4.206
 - FSE-B5 - FFT Filter..... 1.42, 1.43
 - FSE-B8/B9/B10/B11 - Tracking Generator..... 4.192
 - FSE-B13 - 1 dB Attenuator..... 4.102, 4.103
 - FSE-B16 - Ethernet Adapter..... 1.44, 1.73
 - FSE-B17 - Second IEC/IEEE bus interface..... 1.40
 - Output
 - AF..... 8.22, 8.24
 - buffer..... 5.17
 - IF..... 8.24
 - level (tracking generator)..... 4.193
 - noise source control..... 8.24
 - reference..... 8.24
 - sweep..... 8.24
 - video out..... 8.24
 - Output device
 - formfeed..... 4.64
 - paperfeed..... 4.65
 - OVLD..... 3.4
- P**
- Packet driver..... 1.78
 - Parallel poll..... 5.33
 - Parallel poll enable register (PPE)..... 5.22
 - Parameter
 - block data..... 5.14
 - boolean..... 5.13
 - numerical values..... 5.13
 - string..... 5.14
 - text..... 5.14
 - Password
 - service function..... 4.33
 - Windows NT..... 1.23
 - Path..... 4.68
 - Peak
 - detector..... 4.161
 - excursion..... 4.135
 - search..... 4.134
 - Plotter connection..... 1.66
 - Power mean..... 4.139
 - Power measurement
 - adjacent channel..... 4.122
 - automatic optimisation of settings..... 4.125
 - bandwidth, occupied..... 4.124

channel..... 4.118
channel configuration 4.113
signal/noise 4.120
PPE (parallel poll enable register)..... 5.22
Preset..... 4.2
Pre-trigger..... 4.190
Printer connection..... 1.28, 1.66, 8.22
Printing
 abort..... 4.51
 Configuration..... 4.54
 start..... 4.50
Probe Code connector..... 8.23
Probe Power connector 8.23
PTRansition register part..... 5.19

Q

Quasi analog display 4.165
Query..... 5.12, 5.33
Question mark 5.12, 5.14
Quotation mark 5.14

R

Rack installation 1.19, 1.56
Range
 level..... 4.98
Recall data set..... 4.75
Recording the correction data 4.9
Reference
 dataset (tracking generator)..... 4.201
 external 4.31
 line 4.145
Reference level..... 4.94
 offset 4.95
Remote control
 basics..... 5.1
 IEC-bus 5.3
 indication 4.49, 5.2
 RS-232-C 5.4
 RSIB..... 5.6, 8.10
 switch over 5.2
Rename
 directory 4.69
 file 4.69
Reset
 device..... 4.2
 status reporting system 5.34
Resolution bandwidth 4.171
RF attenuation 4.100
 auto 4.101
 auto low distortion 4.101
 auto low noise 4.101
RF input..... 4.100
RJ45 (star topology) 1.45, 1.74
RMS detector..... 4.164
RMS value (summary marker) 4.139
Roll-key 3.14
RS-232-C
 interface 8.6
 interface functions 8.7
 transmission parameters 8.7
RSIB interface 8.10

S

Sample detector 4.164
Save
 configuration 4.66
 data set..... 4.70
 limit line..... 4.155
 measurement..... 4.66
SCPI
 conformance information..... 6.1
 introduction 5.9
Screen..... 3.2, 4.4
 full screen 3.9
 indications 3.4
 split screen..... 3.9
Search
 limit 4.137
 minimum 4.134
 peak..... 4.134
Self test..... 4.15
Serial interface
 configuration 4.36, 4.42
Serial poll 5.32
Service functions..... 4.32
Service Pack 1.39
Service request (SRQ) 5.21, 5.32
 indication..... 4.49
Service request enable register (SRE) 5.21
Setup 4.20
 general..... 4.34, 4.40
Softkey
 % POWER BANDWIDTH..... 4.117, 6.205
 ACP STANDARD..... 4.115, 6.52
 ACTIVE MKR / DELTA 4.134
 ACTIVE SCREEN A/B 4.4
 ADJACENT CHAN POWER..... 4.122, 6.50, 6.51
 ADJUST CP SETTINGS 4.125, 6.205
 ADJUST TO TRACE..... 4.165, 4.166
 ALL DELTA OFF..... 4.129, 6.10
 ALL MARKER OFF..... 4.108, 6.39
 ALL SUM MKR OFF 4.140, 6.59
 AM 4.109, 4.110, 6.45
 AMPERE..... 4.98, 6.62
 ANALOG TR ON/OFF..... 4.165, 6.99
 ANALYZER..... 4.18, 4.84, 6.130
 APPEND NEW..... 4.167, 6.118
 area 3.10
 ASCII COMMENT 4.168, 6.118
 ASCII CONFIG..... 4.167
 ASCII EXPORT..... 4.167, 6.138
 ATT SWITCHES 4.17, 6.90
 ATTEN AUTO LOW DIST 4.101, 6.127
 ATTEN AUTO LOW NOISE 4.101, 6.127
 ATTEN AUTO NORMAL 4.101, 6.127
 ATTEN STEP 1dB/10dB 4.102, 4.104, 6.128
 AUTO 0.1 * RBW 4.89, 6.194
 AUTO 0.1 * SPAN 4.89, 6.194
 AUTO 0.5 * RBW 4.90, 6.194
 AUTO 0.5 * SPAN 4.90, 6.194
 AUTO RECALL 4.76, 6.136
 AUTO SELECT 4.163, 6.181
 AUTO x * RBW 4.90, 6.194
 AUTO x * SPAN..... 4.90, 6.194
 AVERAGE 4.158, 6.98, 6.166
 AVERAGE ON/OFF 4.140, 6.59
 BASELINE CLIPPING..... 4.146, 6.16
 BLANK..... 4.158, 6.99
 BRIGHTNESS..... 4.6, 6.93
 C/N 4.120, 6.50, 6.51
 C/No 4.120, 6.50, 6.51
 CAL CORR ON/OFF..... 4.11, 6.64
 CAL I/Q..... 4.10, 6.63

| | | | |
|--------------------------------|--------------------------------|-------------------------------------|---------------------------------------|
| CAL LO SUPP..... | 4.10, 6.64 | DISPLAY COMMENT | 4.7, 6.94 |
| CAL LOG..... | 4.10, 6.64 | DISPLAY LINE 1/2..... | 4.145, 6.15 |
| CAL REFL OPEN..... | 4.200, 6.172 | EDIT ACP LIMITS..... | 4.117, 6.33, 6.34, 6.35 |
| CAL REFL SHORT..... | 4.200, 6.172 | EDIT COMMENT | 4.71, 6.142 |
| CAL RES BW..... | 4.10, 6.63 | EDIT LIMIT LINE..... | 4.152, 6.22 |
| CAL RESULTS..... | 4.12 | EDIT NAME | 4.71, 4.76, 6.135, 6.137 |
| CAL SHORT..... | 4.10, 6.64 | EDIT PATH..... | 4.68, 4.71, 4.76, 4.167, 6.133, 6.137 |
| CAL TOTAL..... | 4.10, 6.63 | EDIT TRD FACTOR..... | 4.24, 6.174 |
| CAL TRANS..... | 4.195, 6.172 | EDIT TRD SET | 4.27, 6.176 |
| CENTER FIXED..... | 4.85, 4.86, 4.92, 6.194, 6.195 | ENABLE ALL ITEMS | 4.74, 4.79, 6.141 |
| CENTER MANUAL..... | 4.87, 6.193 | ENABLE DEV1 / DEV2..... | 4.59, 4.65 |
| CH FILTER ON/OFF..... | 4.116, 6.52 | ENABLE OPTION..... | 4.31 |
| CHANNEL BANDWIDTH..... | 4.116, 6.204 | ENTER PASSWORD..... | 4.33, 6.230 |
| CHANNEL POWER..... | 4.118, 6.50, 6.51 | ENTER TEXT | 4.57 |
| CHANNEL SPACING..... | 4.117, 6.203 | EXCLUDE LO ON/OFF..... | 4.135, 6.40 |
| CLEAR ALL MESSAGES..... | 4.16 | EXECUTE TESTS | 4.15, 6.7 |
| CLEAR MESSAGE..... | 4.16, 6.230 | EXT ALC..... | 4.204, 6.213 |
| CLEAR/WRITE..... | 4.157, 6.98 | EXT AM..... | 4.204, 6.212 |
| COLOR ON/ OFF..... | 4.55, 6.121 | EXT FM | 4.204, 6.213 |
| COM PORT 1/2..... | 4.36, 4.42, 6.227, 6.228 | EXT I/Q..... | 4.205, 6.212 |
| COMMENT SCREEN A/B..... | 4.57, 6.123 | EXT REF FREQUENCY | 4.31, 6.206 |
| CONFIG..... | 4.167 | EXTERN (trigger)..... | 4.179, 6.235, 6.236 |
| CONFIG DISPLAY..... | 4.6 | EXTERNAL KEYBOARD..... | 4.47 |
| CONTINUOUS SWEEP | 4.180, 6.125 | FIRMWARE UPDATE..... | 4.47, 6.230 |
| COPY..... | 4.69, 6.134 | FIRMWARE VERSION..... | 4.13, 6.5 |
| COPY (TRACE)..... | 4.160, 6.234 | FM..... | 4.109, 4.110, 6.45 |
| COPY LIMIT LINE..... | 4.150, 6.28 | FORMAT DISK | 4.69, 6.135 |
| COPY SCREEN..... | 4.55, 6.122 | FREE RUN | 4.178, 6.235 |
| COPY TABLE..... | 4.55, 6.123 | FREQ AXIS LIN/LOG..... | 4.85, 6.210 |
| COPY TRACE..... | 4.55, 6.124 | FREQUENCY LINE 1/2..... | 4.145, 6.17 |
| COUNTER RESOL..... | 4.112, 6.40 | FREQUENCY OFFSET | 4.88, 4.202, 6.196 |
| COUPLING CONTROL..... | 4.5, 6.131 | FREQUENCY ON/OFF..... | 4.7, 6.92 |
| COUPLING DEFAULT | 4.173, 6.168, 6.207 | FULL PAGE..... | 4.56, 6.124 |
| COUPLING RATIO..... | 4.176 | FULL SCREEN..... | 4.4, 6.92 |
| CP/ACP ABS/REL..... | 4.119, 6.205 | FULL SPAN..... | 4.92, 6.194 |
| DATA ENTRY FIELD..... | 4.8 | GAP LENGTH..... | 4.191, 6.210 |
| DATA SET CLEAR..... | 4.72, 6.138 | GAP SWEEP ON/OFF..... | 4.189, 6.209 |
| DATA SET CLEAR ALL..... | 4.72, 6.138 | GAP SWEEP SETTINGS | 4.190 |
| DATA SET LIST..... | 4.71 | GATE ADJUST..... | 4.186 |
| DATAENTRY OPAQUE | 4.8 | GATE DELAY..... | 4.185, 6.209 |
| DATAENTRY X..... | 4.8 | GATE EXTERN..... | 4.185, 6.209 |
| DATAENTRY Y..... | 4.8 | GATE LENGTH..... | 4.185, 6.209 |
| DATE..... | 4.45, 6.229 | GATE LEVEL..... | 4.184, 6.208 |
| dB*/MHz..... | 4.97, 6.62 | GATE MODE LEVEL/EDGE | 4.184, 6.208 |
| dB μ A..... | 4.97, 6.62 | GATE ON / OFF..... | 4.183, 6.208 |
| dB μ V..... | 4.97, 6.62 | GATE POL..... | 4.184, 6.208 |
| dBm..... | 4.97, 6.62 | GATE RF POWER..... | 4.185, 6.209 |
| dBmV..... | 4.97, 6.62 | GATE SETTINGS..... | 4.184 |
| dBpW..... | 4.97, 6.62 | GENERAL SETUP..... | 4.34, 4.40 |
| DECIM SEP | 4.167, 6.118 | GPIO ADDRESS..... | 4.34, 4.40, 6.226 |
| DEFAULT COLORS..... | 4.7, 6.93 | GRID ABS/REL..... | 4.95, 4.99, 6.96 |
| DEFAULT CONFIG..... | 4.74, 6.142 | HARDCOPY DEVICE | 4.58, 4.60, 6.121 |
| DEFAULT POSITION..... | 4.8 | HARDWARE+OPTIONS..... | 4.14, 6.6 |
| DEFINE MACRO..... | 4.82 | HEADER ON/OFF..... | 4.167, 6.118 |
| DEFINE PAUSE..... | 4.83 | HOLD CONT ON/OFF..... | 4.160, 6.99 |
| DELETE..... | 4.69, 6.135, 6.137 | HORIZONTAL SCALING | 4.5, 6.131 |
| DELETE FACTOR/SET..... | 4.23, 6.175, 6.177 | INPUT CAL..... | 4.32, 6.89 |
| DELETE LIMIT LINE..... | 4.150, 6.28 | INPUT RF..... | 4.32, 6.89 |
| DELETE MACRO..... | 4.83 | INPUT SELECT | 4.101, 4.102 |
| DELETE VALUE (limit line)..... | 4.155 | INSERT VALUE (limit line)..... | 4.155 |
| DELTA 1 to 4..... | 4.128, 6.9, 6.10, 6.11 | KEY CLICK ON/OFF..... | 4.40 |
| DELTA 1/2..... | 6.9, 6.10, 6.11 | LAST SPAN..... | 4.92 |
| DELTA ABS REL..... | 4.129, 6.10 | LIMIT CHECK..... | 4.117, 6.33, 6.34, 6.35 |
| DELTA TO STEPSIZE | 4.127 | LINE (trigger)..... | 4.178, 6.235 |
| DETECTOR..... | 4.163 | LINEAR/%..... | 4.99, 6.98 |
| DETECTOR AUTOPEAK..... | 4.163, 6.181 | LINEAR/dB | 4.99, 6.98 |
| DETECTOR AVERAGE..... | 4.164, 6.181 | LOCK ALL..... | 3.19 |
| DETECTOR MAX PEAK..... | 4.163, 6.181 | LOCK DATA | 3.19 |
| DETECTOR MIN PEAK..... | 4.163, 6.181 | LOG 10dB/20dB/50dB/100dB/120dB..... | 4.98 |
| DETECTOR RMS..... | 4.164, 6.181 | LOG MANUAL | 4.99, 6.96, 6.98 |
| DETECTOR SAMPLE..... | 4.164, 6.181 | LOGO ON/OFF..... | 4.7, 6.92 |
| DISABLE ALL ITEMS..... | 4.74, 4.79, 6.142 | | |

| | | | |
|---|--------------------------|---|---------------------------------------|
| LOWER LEFT | 4.56, 6.124 | REF POINT LEVEL..... | 4.130, 6.13 |
| LOWER RIGHT | 4.56, 6.124 | REF POINT LVL OFFSET | 4.130, 6.13 |
| MACRO 1 to 7..... | 4.81 | REF POINT TIME | 4.130, 6.13 |
| MACRO TITLE..... | 4.83 | REF VALUE..... | 4.198, 6.97 |
| MAIN PLL BANDWIDTH | 4.175, 6.170 | REF VALUE POSITION..... | 4.197, 6.98 |
| MAKE DIRECTORY..... | 4.69, 6.136 | REFERENCE..... | 4.33, 6.206 |
| MARGIN..... | 6.61 | REFERENCE FIXED | 4.129, 6.13 |
| MARKER 1 to 4..... | 4.106, 6.39, 6.41 | REFERENCE INT/EXT | 4.31, 6.206 |
| MARKER 1/2..... | 6.39, 6.41 | REFERENCE LINE | 4.145, 6.17 |
| MARKER DEMOD..... | 4.109, 4.110 | REFERENCE POINT..... | 4.130, 6.13 |
| MARKER INFO 4.109, 6.14, 6.44, 6.51, 6.57, 6.58, 6.94 | | REFERENCE PROG | 4.33, 6.206 |
| MARKER ZOOM | 4.109, 6.45 | RENAME | 4.69, 6.136 |
| MAX HOLD | 4.159, 6.98, 6.166 | RES BW 3dB/6dB..... | 4.172, 6.168 |
| MAX LEVEL AUTO | 4.95, 6.97 | RES BW AUTO..... | 4.171, 6.168 |
| MAX LEVEL MANUAL..... | 4.95, 6.97 | RES BW MANUAL..... | 4.172, 6.167 |
| MEAN..... | 4.139, 6.58 | RESTORE | 4.47 |
| MIN | 4.134, 6.12, 6.42 | RF ATTEN MANUAL..... | 4.100, 6.127 |
| MIN HOLD..... | 4.160, 6.98, 6.166 | RF INPUT 50 OHM..... | 4.101, 4.102, 6.128 |
| MIXER LEVEL..... | 4.101, 6.129 | RF INPUT 75 OHM/RAM | 4.101, 4.102, 6.129 |
| MKR -> CENTER..... | 4.141, 6.59 | RF INPUT 75 OHM/RAZ..... | 4.101, 4.102, 6.129 |
| MKR -> CF STEPSIZE..... | 4.142, 6.59 | RF POWER (trigger)..... | 4.179, 6.235 |
| MKR -> REF LEVEL..... | 4.142, 6.60 | RMS..... | 4.139, 6.57 |
| MKR -> START | 4.142, 6.60 | SATURATION..... | 4.7, 6.93 |
| MKR -> STOP | 4.142, 6.60 | SAVE LIMIT LINE | 4.155 |
| MKR -> TRACE..... | 4.142, 6.10, 6.39 | SCR. SAVER ON/OFF..... | 4.7, 6.100 |
| MKR DEMOD ON/OFF..... | 4.109, 4.110, 6.46 | SCR. SAVER TIME..... | 4.7, 6.100 |
| MKR STOP TIME..... | 4.109, 4.110, 6.46 | SCREEN A BARGRAPH..... | 4.4 |
| MKR TO STEPSIZE..... | 4.127, 6.60 | SCREEN A SWEEP..... | 4.4 |
| MODE COUPLED | 4.5, 6.131 | SCREEN COUPLING | 4.5 |
| MODULATION | 4.203 | SCREENS UNCOUPLED | 4.5, 6.131 |
| MONITOR CONNECTED | 4.39 | SEARCH LIMIT ON/OFF | 4.137, 6.39 |
| MOUSE..... | 4.46 | SELECT ITEMS.. 4.74, 4.79, 6.138, 6.139, 6.140, 6.141 | |
| MOVE ZOOM START | 4.93, 6.95 | SELECT LIMIT LINE..... | 4.148, 6.21, 6.22, 6.28 |
| MOVE ZOOM STOP | 4.93, 6.95 | SELECT MACRO..... | 4.83 |
| MOVE ZOOM WINDOW | 4.93, 6.96 | SELECT MARKER..... | 4.134 |
| N dB DOWN..... | 4.137, 6.44 | SELECT OBJECT..... | 4.6 |
| NAME (limit line)..... | 4.153, 6.28 | SELECT QUADRANT..... | 4.56 |
| NEW FACT/SET..... | 4.24, 4.27, 6.173, 6.175 | SELFTEST..... | 4.15, 6.7 |
| NEW LIMIT LINE..... | 4.152 | SERVICE | 4.32, 6.89 |
| NEXT MIN | 4.135, 6.12, 6.42 | SET CP REFERENCE..... | 4.119, 6.205 |
| NEXT MIN LEFT | 4.135, 6.12, 6.42 | SET NO. OF ADJ CHAN'S..... | 4.114, 6.204 |
| NEXT MIN RIGHT..... | 4.135, 6.12, 6.42 | SETTINGS DEVICE 1/2..... | 4.58, 4.61 |
| NEXT PEAK..... | 4.134, 6.11, 6.41 | SGL SWEEP DISP OFF | 4.181, 6.126 |
| NEXT PEAK LEFT | 4.134, 6.12, 6.42 | SHAPE FACT 60/3dB..... | 4.138, 6.46 |
| NEXT PEAK RIGHT..... | 4.134, 6.11, 6.41 | SHAPE FACT 60/6dB..... | 4.138, 6.46 |
| NOISE..... | 4.112, 6.45 | SHIFT X LIMIT LINE..... | 4.155, 6.23 |
| NOISE SOURCE..... | 4.32, 6.89 | SHIFT Y LIMIT LINE..... | 4.155, 6.25, 6.26 |
| NORMALIZE | 4.196, 6.172 | SIGNAL COUNT..... | 4.111, 6.40 |
| OCCUPIED PWR BANDW..... | 4.124, 6.50, 6.51 | SIGNAL TRACK..... | 4.108, 6.47 |
| OPTIONS..... | 4.14, 4.31, 6.6 | SINGLE SWEEP..... | 4.180, 6.125 |
| PEAK | 4.134, 6.11, 6.41 | SLOPE POS/NEG..... | 4.179, 6.237 |
| PEAK EXCURSION | 4.135, 6.43 | SORT MODE | 4.69 |
| PEAK HOLD ON/OFF | 4.140, 6.59 | SOURCE CAL..... | 4.194 |
| PHASE NOISE..... | 4.131, 6.13 | SOURCE ON/OFF | 4.193, 6.143 |
| POWER MEAS SETTINGS..... | 4.114 | SOURCE POWER | 4.193, 6.213 |
| POWER OFFSET..... | 4.193, 6.213 | SPAN / RBW AUTO [50]..... | 4.177, 6.168 |
| PRE TRIGGER (gap sweep)..... | 4.190, 6.209 | SPAN / RBW MANUAL..... | 4.177, 6.168 |
| PREDEFINED COLORS | 4.7, 6.93 | SPAN FIXED | 4.84, 4.86, 4.88, 6.193, 6.195 |
| PRESEL PEAK | 4.11, 6.64 | SPAN MANUAL | 4.91, 6.194 |
| PROBE CODE ON/OFF..... | 4.98, 6.240 | SPLIT SCREEN..... | 4.4, 6.92 |
| RBW / VBW MANUAL | 4.177, 6.169 | START FIXED | 4.86, 4.88, 4.92, 6.193, 6.194, 6.195 |
| RBW / VBW NOISE..... | 4.177, 6.169 | START MANUAL | 4.84, 6.195 |
| RBW / VBW PULSE..... | 4.177, 6.169 | STATISTICS | 4.17, 6.90 |
| RBW / VBW SINE [1]..... | 4.176, 6.169 | STEPSIZE = CENTER..... | 4.90 |
| RBW <= NORM/FFT | 4.174, 6.168 | STEPSIZE AUTO..... | 4.127, 6.14, 6.43 |
| RBW 1kHz ANA/DIG | 4.173, 6.168 | STEPSIZE MANUAL..... | 4.90, 4.127, 6.14, 6.43, 6.193 |
| RBW UP/DOWN..... | 4.173 | STOP FIXED | 4.84, 4.88, 4.92, 6.193, 6.194, 6.195 |
| RECALL | 4.199, 6.172 | STOP MANUAL | 4.86, 6.195 |
| RECORD ON/OFF | 4.82 | SUM MKR..... | 4.138, 6.52 |
| REF LEVEL | 4.95, 6.96 | SUMMARY MARKER | 4.139 |
| REF LEVEL OFFSET..... | 4.95, 6.97 | SWEEP COUNT | 4.140, 4.159, 4.181, 6.208 |
| REF POINT FREQUENCY..... | 4.130, 6.13 | SWEEP TIME AUTO | 4.173, 6.207 |

- SWEEP TIME MANUAL 4.173, 6.207
 - SYSTEM MESSAGES 4.16, 6.230
 - T1-REF 4.165, 4.166, 6.61
 - T1-T2+REF 4.165, 4.166, 6.61
 - T1-T3+REF 4.165, 4.166, 6.61
 - THRESHOLD LINE 4.145, 6.16
 - TIME 4.39, 4.45, 6.231
 - TIME LINE 1/2 4.146, 6.17
 - TIME ON/OFF 4.7, 6.95
 - TINT 4.6, 6.93
 - TITLE 4.57, 6.123
 - TRACE MATH 4.165
 - TRACE MATH OFF 4.165, 4.166, 6.61
 - TRACKING GENERATOR 4.18, 4.193, 6.130, 6.143
 - TRANSD SET RANGES 4.29, 6.176
 - TRANSD SET UNIT 4.28, 6.176
 - TRANSDUCER FACTOR 4.22, 6.174
 - TRANSDUCER SET 4.22, 6.175, 6.177
 - TRC COLOR AUTO INC 4.55, 6.124
 - TRD FACTOR NAME 4.25, 6.173
 - TRD FACTOR UNIT 4.25, 6.173
 - TRD FACTOR VALUES 4.26, 6.174
 - TRD SET NAME 4.28, 6.175
 - TRG TO GAP TIME 4.191, 6.210
 - TRIGGER DELAY 4.179, 6.236
 - TRIGGER LEVEL (gap sweep) 4.190, 6.236
 - UNIT 4.96, 6.240
 - UNLOCK 3.19
 - UPDATE 4.47
 - UPDATE MESSAGES 4.16
 - UPPER LEFT 4.56, 6.124
 - UPPER RIGHT 4.56, 6.124
 - USER PORT A/B 4.35, 4.41, 6.128, 6.143
 - VALUES (limit line) 4.154, 6.25
 - VECTOR ANALYZER 4.19, 6.130
 - VERTICAL SCALING 4.5, 6.131
 - VIDEO (trigger) 4.178, 6.235, 6.236
 - VIDEO BW AUTO 4.172, 6.169
 - VIDEO BW MANUAL 4.172, 6.169
 - VIEW 4.157, 6.98
 - VOLT 4.98, 6.62
 - VOLUME 4.110, 6.231
 - WATT 4.98, 6.62
 - X OFFSET 4.150, 6.23
 - Y OFFSET 4.150, 6.24, 6.26
 - ZERO SPAN 4.91, 6.194
 - ZOOM 4.93, 6.95
 - ZOOM OFF 4.93, 6.95
 - Span 4.91
 - measurement window 4.84
 - Special characters 6.2
 - Split screen 3.9, 4.4
 - Split screen mode 4.4
 - SRE (service request enable register) 5.21
 - SRQ (service request) 5.21, 5.32
 - Start frequency
 - sweep 4.84
 - Start-Up 1.18, 1.56
 - Status byte (STB) 5.21
 - Status information 3.4
 - DIFOVL 3.4
 - ExtRef 3.4
 - IFOVLD 3.4
 - LO LvD 3.4
 - LO Lvl 3.4
 - LO unl 3.4
 - MAX / REF LVL 3.4
 - OCXO 3.4
 - OVLd 3.4
 - UNCAL 3.4
 - Status register
 - CONDition part 5.19
 - ENABLE part 5.19
 - ESE 5.22
 - ESR 5.22
 - EVENT part 5.19
 - NTRansition part 5.19
 - overview 5.20
 - PPE 5.22
 - PTRansition part 5.19
 - SRE 5.21
 - STATus OPERation 5.23
 - STATus QUEStionable 5.24
 - ACPLimit 5.25
 - FREQuency 5.26
 - LIMit 5.27
 - LMARgin 5.28
 - POWer 5.29
 - SYNC 5.30
 - TRANsducer 5.31
 - STB 5.21
 - structure 5.18
 - sum bit 5.19
 - Status reporting system 5.18
 - resetting values 5.18, 5.34, 6.214
 - STB (status byte) 5.21
 - Step size
 - center frequency 4.89
 - delta marker 4.132
 - marker 4.127
 - setting 3.20
 - Stop frequency
 - sweep 4.86
 - String 5.14
 - Suffix 5.11
 - Sum bit 5.19
 - Supply voltage, external noise source 4.32
 - Sweep
 - count 4.159, 4.181
 - coupling 4.170
 - gap 4.188
 - gap length 4.191
 - gated 4.182
 - mode 4.180
 - single 4.180
 - time 4.173
 - Switching on/off 1.20
 - Switching operations 4.17
 - Syntax elements
 - command 5.14
 - System messages 4.16
- ## T
- Table entry 3.18
 - TCP/IP operation 1.54, 1.85
 - Test functional 1.58
 - Text parameter 5.14
 - Thick Ethernet 1.45, 1.74
 - Thin Ethernet 1.44, 1.73
 - Time 4.39, 4.45
 - Trace 4.156
 - copy 4.160
 - detector 4.161
 - export 4.167
 - mathematics 4.165
 - Transducer 4.20
 - entry 4.23
 - set 4.27
 - switch on 4.21
 - Transmission parameters of RS-232-C 4.194, 8.7

| | |
|---------------------|-------|
| Trigger | |
| delay | 4.179 |
| external | 4.179 |
| free run..... | 4.178 |
| gap sweep..... | 4.190 |
| line | 4.178 |
| pre-trigger..... | 4.190 |
| RF power..... | 4.179 |
| slope | 4.179 |
| video | 4.178 |
| TV demodulator..... | 4.206 |
| TV-Trigger..... | 4.208 |

U

| | |
|------------------------|------------|
| UNCAL | 3.4 |
| Units..... | 4.96 |
| Universal command..... | 8.5 |
| UNLD..... | 3.4 |
| Upper case | 6.2 |
| User port | |
| configuration..... | 4.35, 4.41 |
| interface | 8.21 |

V

| | |
|---------------------------|--------------|
| Vector analyzer mode..... | 4.19 |
| Video bandwidth | 4.172 |
| View | 4.157 |
| Volume | 4.109, 4.110 |

W

| | |
|--------------------|------|
| White space..... | 5.14 |
| Windows NT..... | 1.23 |
| administrator..... | 1.23 |
| login | 1.23 |
| password..... | 1.23 |

Z

| | |
|-----------------|-------------|
| Zero span | 4.91 |
| Zoom | 4.93, 4.157 |
| amplitude..... | 4.157 |